

Marque distribuée par SPX Lighting



333 avenue Marguerite Perey
Bâtiment Innovespace C
77127 LIEUSAIN
+33 (0)1 82 33 02 80
contact@spx-lighting.com
www.spx-lighting.com

formalighting

High Performance Linear Lights

2020 | 21

High Performance Linear Lights

Plastic free packaging

High Performance Linear Lights

Microline Series

Microline 5 x 5



p. 08

Microline 7 x 7



p. 10

Microline 7 x 7
Chain

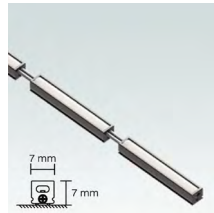

p. 12

Microline 7 x 7
Corner



p. 14

Microline 7 x 7
Corner Chain



p. 16

Microline 10 x 6



p. 18

Microline 9 x 8



p. 20

Microline Ø9



p. 22

Microline Ø14



p. 24

Microline Ø14
Chain



p. 26

Microline 14 x 14



p. 28

Microline 14 x 14
Chain

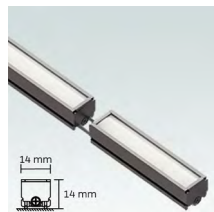

p. 30

Microline 14 x 14
Corner



p. 32

Microline Spot



p. 34

Microline Spot
Chain



p. 36

High Performance Linear Lights

Cobra Series

Mini Cobra Linealuce



p. 38

Mini Cobra Flex



p. 40

Mini Cobra Linealuce Louvre



p. 42

Mini Cobra Flex Louvre



p. 44

Mini Cobra Pro



p. 46

Mini Cobra Pro Louvre



p. 48

Cobra Linealuce



p. 50

Cobra Flex



p. 52

Cobra Linealuce Louvre



p. 54

Cobra Flex Louvre



p. 56

Cobra Pro IP66 Fixed



p. 58

Cobra Pro IP66 Adjustable



p. 60

Complete Length Codes List



p. 62

Driver Options + Accessories



p. 81

Code Ordering System



p. 91



Plastic free packaging



Microline

5 x 5



Body

Surface mounted modular LED system in extruded aluminium.
Available in different length configurations starting from 55mm with increment of 45mm.
Section 5.8mm width and 5mm height.

Mounting options:
U clips.

*** Plastic free packaging.**

Accessories

Mounting accessories included.
Extension cable Art. 2D58 to be ordered separately.

Finish

Anodized black or aluminium finish.

LED sources

SMD.
CRI: 97 | R9: >90 | CCT: 2700K, 3000K, 3500K, 4000K. 3-Step
McAdam.
Other CRI and CCT options available on request.

Optic

Extra Wide Beam Angle.
Opal Rigid Diffuser (RD).

Driver

Driver not included to be ordered separately.
Work with 24V Constant Voltage Driver positioned remotely.
See page 82 for further information.

Applications

Micro linear light system with a disappearing look delivers an homogenous and diffuse light effect. Ideal for tiny showcase and under cabinet illumination.
Application areas: Retail, cabinet displays, showcases, jewelry displays, residential, restaurants, museums.

Related Products

Microline
7 x 7
P. 10



Microline 5 x 5



16W/m

Microline

5 x 5



Min. L= 55mm (2.16")

Section Size

Mounting options

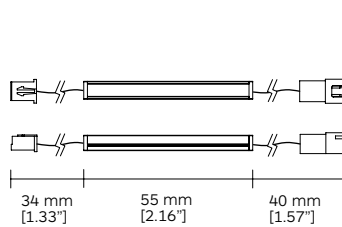

Without U clip

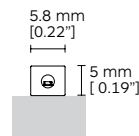

With mounting U clip

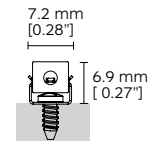

Max. L= 1990mm (78.34")

Increment: 45mm (1.77")

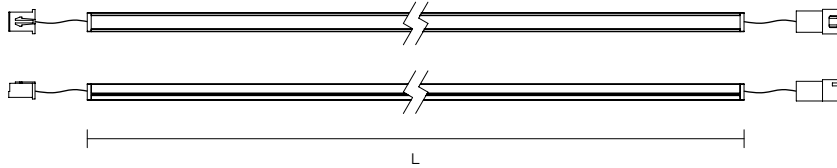

Code ordering example: **G 4 6 6 0 0 5 5 . 9 7 2 7 RD 0 0 1 0**

	Product code*	Length code***	Light Source	>CRI	CCT**	LED Power	Nominal Lumen	Diffuser	Driver Options	Finish
Microline 5 x 5	G466	0055	LED	97	27 2700K	16W/m	1420 lm/m	RD	00 No Driver	10 ■ Black
Min & Max. Length		1990			30 3000K					70 ■ Aluminium
					35 3500K					
					40 4000K					

Recommended Driver:

Driver to be ordered separately. Work with 24VDC Constant Voltage LED Driver positioned remotely.
Suggested Driver: 2V24D0, 2V24D1, 2V24DA. Please see page 82 for further information.

Notes:

* For complete code ordering information, please see page 91.

** For other CCT options, please contact us.

*** For complete list of length codes, please see page 62.

For related accessories, please see page 87.

For the most updated product information, please go to our website.

RD = Opal rigid diffuser. Ordering code: **RD**.

Microline

7 x 7



Body

Surface mounted LED system in extruded aluminium.
Available in different length configurations starting from 50mm with increment of 45mm.
Section 7x7mm.

Mounting options:
Integrated magnets for easy installation.
L brackets.
U mounting clips.

*** Plastic free packaging.**

Accessories

Mounting accessories included.
Extension cable Art. 2D58 to be ordered separately.

Finish

Anodized black or aluminium finish.

LED sources

SMD.
CRI: 97 | R9: >90 | CCT: 2700K, 3000K, 3500K, 4000K.
3-Step MacAdam.
Other CRI and CCT options available on request.

Optic

Extra Wide Beam Angle.
Opal Diffuser (OD).
Lenticular Transparent Diffuser (TD).
Opal Rigid Diffuser (RD).

Driver

Driver not included to be ordered separately.
Work with 24V Constant Voltage Driver positioned remotely.
See page 82 for further information.

Applications

Miniature linear light with a disappearing look delivers an homogenous and diffuse light effect, making it the ideal product for showcase and under cabinet illumination.
Application areas: Retail, cabinet displays, showcases, jewelry displays, residential, restaurants, museums.

Related Products

Microline 7 x 7 Chain

P. 12



Microline 7 x 7 Corner

P. 14



Microline 7 x 7 Corner Chain

P. 16



Microline 7 x 7



19W/m

Microline
7 x 7



Min. L= 50mm (1.96")

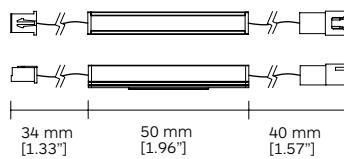

Mounting options

With magnet L bracket

With mounting U clip

With magnet

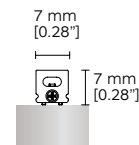
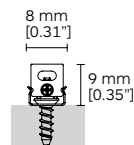
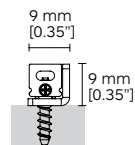

Max. L= 2030mm (79.92")

Increment: 45mm (1.77")

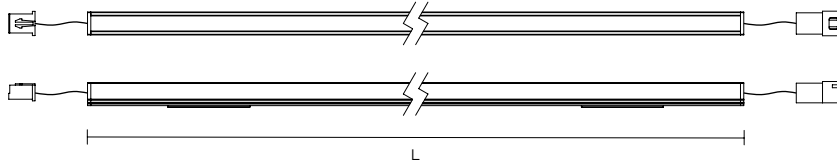

Code ordering example: **G 4 4 7 0 0 5 0 - 9 7 2 7 OD 0 0 1 0**

	Product code*	Length code***	Light Source	>CRI	CCT**	LED Power	Nominal Lumen	Diffuser	Driver Options	Finish
Microline 7 x 7	G447	0050	LED	97	27 2700K	19W/m	1694 lm/m	OD	00 No Driver	10 ■ Black
Min & Max. Length		2030			30 3000K			TD		70 ■ Aluminium
					35 3500K			RD		
					40 4000K					

Recommended Driver: Driver to be ordered separately. Work with 24VDC Constant Voltage LED Driver positioned remotely. Suggested Driver: 2V24D0, 2V24D1, 2V24DA. Please see page 82 for further information.

Notes:

* For complete code ordering information, please see page 91.

** For other CCT options, please contact us.

*** For complete list of length codes, please see page 63.

For related accessories, please see page 87.

For the most updated product information, please go to our website.

OD = Opal diffuser. Ordering code: **OD**.

TD = Transparent lenticular diffuser. Ordering code: **TD**.

RD = Opal rigid diffuser. Ordering code: **RD**.

Microline

7 x 7 Chain



Body

Surface mounted modular flexible LED system in extruded aluminium.
Available in different length configurations based on 49mm link with increment of 59mm.
Section 7x7mm.

Mounting options:
Integrated magnets for easy installation.
L brackets.
U mounting clips.

*** Plastic free packaging.**

Accessories

Mounting accessories included.
Extension cable Art. 2D58 to be ordered separately.

Finish

Anodized black or aluminium finish.

LED sources

SMD.
CRI: 97 | R9: >90 | CCT: 2700K, 3000K, 3500K, 4000K.
3-Step MacAdam.
Other CRI and CCT options available on request.

Optic

Extra Wide Beam Angle.
Opal Diffuser (OD).
Lenticular Transparent Diffuser (TD).
Opal Rigid Diffuser (RD).

Driver

Driver not included to be ordered separately.
Work with 24V Constant Voltage Driver positioned remotely.
See page 82 for further information.

Applications

Curvaceous miniature linear light with a disappearing look delivers an homogenous and diffuse light effect, making it the ideal product for showcase and under cabinet illumination.
Application areas: Retail, cabinet displays, showcases, jewelry displays, residential, restaurants, museums.

Related Products

Microline 7 x 7

P. 10



Microline 7 x 7 Corner

P. 14



Microline 7 x 7 Corner Chain

P. 16



Microline 7 x 7 Chain



0.86W/Link

Microline
7 x 7 Chain



Min. L= 49mm (1.92"), 1 Link

Mounting options

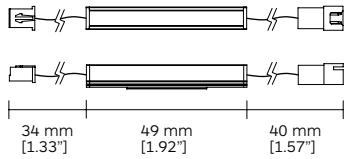

With magnet L bracket

With mounting U clip

With magnet

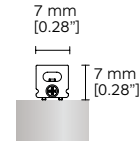
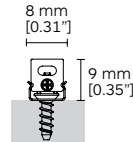
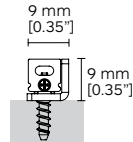

Max. L= 2645mm (104.13"), 45 Links

Increment: 59mm (2.32"), 1 Link

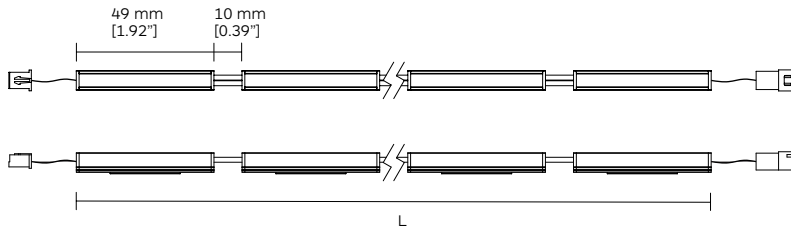

Code ordering example: **G 4 4 2 0 0 4 9 - 9 7 2 7 O D 0 0 1 0**

	Product code*	Length code***	Light Source	>CRI	CCT**	LED Power	Nominal Lumen	Diffuser	Driver Options	Finish
Microline 7 x 7 Chain	G442	0049	LED	97	27 2700K	0.86W/Link	77 lm/Link	OD	00 No Driver	10 ■ Black
Min & Max. Length		2645			30 3000K			TD		70 ■ Aluminium
					35 3500K			RD		
					40 4000K					

Recommended Driver: Driver to be ordered separately. Work with 24VDC Constant Voltage LED Driver positioned remotely. Suggested Driver: 2V24D0, 2V24D1, 2V24DA. Please see page 82 for further information.

Notes:

- * For complete code ordering information, please see page 91.
- ** For other CCT options, please contact us.
- *** For complete list of length codes, please see page 64.
- For related accessories, please see page 87.
- For the most updated product information, please go to our website.

- OD = Opal diffuser. Ordering code: **OD**.
- TD = Transparent lenticular diffuser. Ordering code: **TD**.
- RD = Opal rigid diffuser. Ordering code: **RD**.

Microline

7 x 7 Corner



Body

Surface mounted LED system in extruded aluminium.
Specific shape to fit in corners.
Available in different length configurations starting from 50mm with increment of 45mm.
Triangular section 7x7mm.

Mounting options:
Integrated magnets for easy installation.
L brackets.
U mounting clips.

*** Plastic free packaging.**

Accessories

Mounting accessories included.
Extension cable Art. 2D58 to be ordered separately.

Finish

Anodized black or aluminium finish.

LED sources

SMD.
CRI: 97 | R9: >90 | CCT: 2700K, 3000K, 3500K, 4000K.
3-Step MacAdam.
Other CRI and CCT options available on request.

Optic

Extra Wide Beam Angle.
Opal Diffuser (OD).
Lenticular Transparent Diffuser (TD).

Driver

Driver not included to be ordered separately.
Work with 24V Constant Voltage Driver positioned remotely.
See page 82 for further information.

Applications

Miniature linear light for showcase and under cabinet diffuse illumination. Its peculiar shape allow it to fit in corners illuminating the surface from a 45 degree angle.
Application areas: Retail, cabinet displays, showcases, jewelry displays, residential, restaurants, museums.

Related Products

Microline 7 x 7

P. 10



Microline 7 x 7 Chain

P. 12



Microline 7 x 7 Corner Chain

P. 16



Microline 7 x 7 Corner



19W/m

Microline
7 x 7 Corner



Min. L= 50mm (1.96")

Mounting options

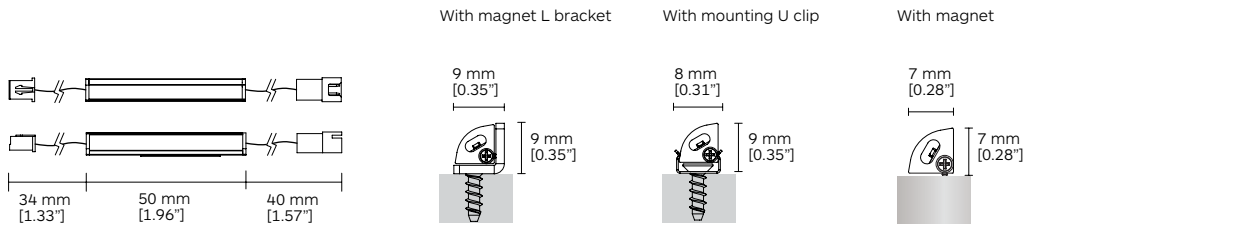

Max. L= 2030mm (79.92")

Increment: 45mm (1.77")

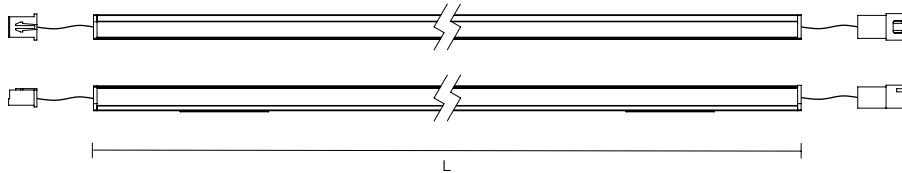

Code ordering example: **G 4 4 6 0 0 5 0 . 9 7 2 7 OD 0 0 1 0**

	Product code*	Length code***	Light Source	>CRI	CCT**	LED Power	Nominal Lumen	Diffuser	Driver Options	Finish
Microline 7 x 7 Corner	G446	0050	LED	97	27 2700K	19W/m	1694 lm/m	OD	00 No Driver	10 ■ Black
Min & Max. Length		2030			30 3000K			TD		70 ■ Aluminium
					35 3500K					
					40 4000K					

Recommended Driver: Driver to be ordered separately. Work with 24VDC Constant Voltage LED Driver positioned remotely. Suggested Driver: 2V24D0, 2V24D1, 2V24DA. Please see page 82 for further information.

Notes:

- * For complete code ordering information, please see page 91.
- ** For other CCT options, please contact us.
- *** For complete list of length codes, please see page 65.
- For related accessories, please see page 87.
- For the most updated product information, please go to our website.

- OD = Opal diffuser. Ordering code: **OD**.
- TD = Transparent lenticular diffuser. Ordering code: **TD**.

Microline

7 x 7 Corner Chain



Body

Surface mounted modular flexible LED system in extruded aluminium.
Available in different length configurations based on 49mm link with increment of 59mm.
Triangular section 7x7mm.

Mounting options:
Integrated magnets, for easy installation.
L brackets.
U mounting clips.

*** Plastic free packaging.**

Accessories

Mounting accessories included.
Extension cable Art. 2D58 to be ordered separately.

Finish

Anodized black or aluminium finish.

LED sources

SMD.
CRI: 97 | R9: >90 | CCT: 2700K, 3000K, 3500K, 4000K.
3-Step MacAdam.
Other CRI and CCT options available on request.

Optic

Extra Wide Beam Angle.
Opal Diffuser (OD).
Lenticular Transparent Diffuser (TD).

Driver

Driver not included to be ordered separately.
Work with 24V Constant Voltage Driver positioned remotely.
See page 82 for further information.

Applications

Curvaceous miniature linear light ideal for showcase and under cabinet diffuse illumination. Its peculiar shape allow it to fit in corners illuminating the surface from a 45 degree angle.
Application areas: Retail, cabinet displays, showcases, jewelry displays, residential, restaurants, museums.

Related Products

Microline 7 x 7

P. 10



Microline 7 x 7 Chain

P. 12



Microline 7 x 7 Corner

P. 14



Microline 7 x 7 Corner Chain



0.86W/Link

Microline
7 x 7 Corner
Chain



Min. L= 49mm (1.92"), 1 Link

Mounting options

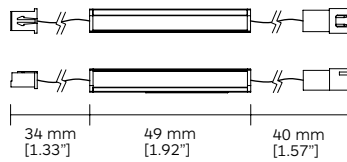

With magnet L bracket

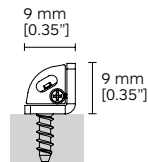

With mounting U clip

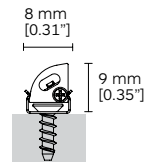

With magnet

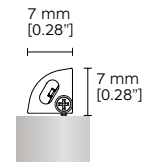

Max. L= 2645mm (104.13"), 45 Links

Increment: 59mm (2.32"), 1 Link

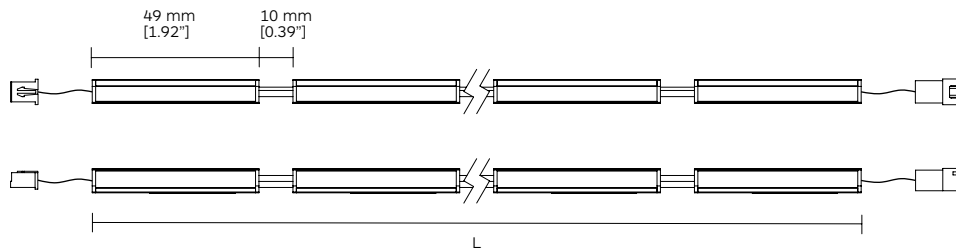

Code ordering example: **G 4 3 1 0 0 4 9 . 9 7 2 7 OD 0 0 1 0**

	Product code*	Length code***	Light Source	>CRI	CCT**	LED Power	Nominal Lumen	Diffuser	Driver Options	Finish
Microline 7 x 7 Corner Chain	G431	0049	LED	97	27 2700K	0.86W/Link	77 lm/Link	OD	00 No Driver	10 ■ Black
Min & Max. Length		2645			30 3000K			TD		70 ■ Aluminium
					35 3500K					
					40 4000K					

Recommended Driver: Driver to be ordered separately. Work with 24VDC Constant Voltage LED Driver positioned remotely. Suggested Driver: 2V24D0, 2V24D1, 2V24DA. Please see page 82 for further information.

Notes:

* For complete code ordering information, please see page 91.

** For other CCT options, please contact us.

*** For complete list of length codes, please see page 66.

For related accessories, please see page 87.

For the most updated product information, please go to our website.

OD = Opal diffuser. Ordering code: **OD**.

TD = Transparent lenticular diffuser. Ordering code: **TD**.

Microline

10 x 6



Body

Surface mounted modular LED system in extruded aluminium.
Available in different length configurations starting from 60mm with increment of 45mm.
Section 10x6mm.

Mounting options:
U mounting clips.

*** Plastic free packaging.**

Accessories

Mounting accessories included.
Extension cable Art. 2D58 to be ordered separately.

Finish

Anodized black or aluminium finish.

LED sources

SMD.
CRI: 97 | R9: >90 | CCT: 2700K, 3000K, 3500K, 4000K.
3-Step MacAdam.
Other CRI and CCT options available on request.

Optic

Extra Wide Beam Angle.
Opal Rigid Diffuser (RD).

Driver

Driver not included to be ordered separately.
Work with 24V Constant Voltage Driver positioned remotely.
See page 83 for further information.

Applications

Miniature linear light with a disappearing look delivers an homogenous and diffuse light effect, making it the ideal product for showcase and under cabinet illumination.
Application areas: Retail, cabinet displays, showcases, jewelry displays, residential, restaurants, museums.

Related Products

Microline
9 x 8
P. 20



Microline 10 x 6



16W/m

Microline

10 x 6



Min. L= 60mm (2.36")

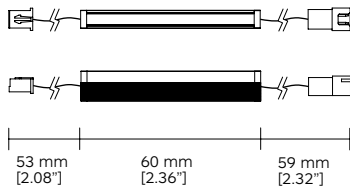

Mounting options

With mounting U clip

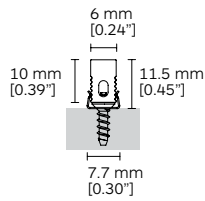

Max. L= 1995mm (78.54")

Increment: 45mm (1.77")

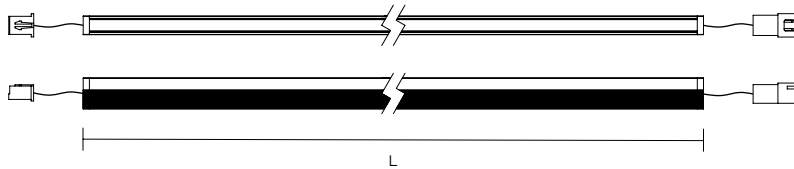

Code ordering example: **G 4 6 0 0 0 6 0 . 9 7 2 7 RD 0 0 1 0**

	Product code*	Length code***	Light Source	>CRI	CCT**	LED Power	Nominal Lumen	Diffuser	Driver Options	Finish
Microline 10 x 6	G460	0060	LED	97	27 2700K	16W/m	1420 lm/m	RD	00 No Driver	10 ■ Black
Min & Max. Length		1995			30 3000K					70 ■ Aluminium
					35 3500K					
					40 4000K					

Recommended Driver: Driver to be ordered separately. Work with 24VDC Constant Voltage LED Driver positioned remotely. Suggested Driver: 2V24D0, 2V24D1, 2V24DA. Please see page 83 for further information.

Notes:

* For complete code ordering information, please see page 91.

RD = Opal rigid diffuser. Ordering code: **RD**.

** For other CCT options, please contact us.

*** For complete list of length codes, please see page 67.

For related accessories, please see page 87.

For the most updated product information, please go to our website.

Microline

9 x 8



Body

Surface mounted modular LED system in extruded aluminium.
Available in different length configurations starting from 60mm with increment of 45mm.
Section 9x8mm.

Mounting options:
U mounting clips.

*** Plastic free packaging.**

Accessories

Mounting accessories included.
Extension cable Art. 2D58 to be ordered separately.

Finish

Anodized black or aluminium finish.

LED sources

SMD.
CRI: 97 | R9: >90 | CCT: 2700K, 3000K, 3500K, 4000K.
3-Step MacAdam.
Other CRI and CCT options available on request.

Optic

Extra Wide Beam Angle.
Opal Rigid Diffuser (RD).

Driver

Driver not included to be ordered separately.
Work with 24V Constant Voltage Driver positioned remotely.
See page 83 for further information.

Applications

Miniature linear light with a disappearing look delivers an homogenous and diffuse light effect, making it the ideal product for showcase and under cabinet illumination.
Application areas: Retail, cabinet displays, showcases, jewelry displays, residential, restaurants, museums.

Related Products

Microline
10 x 6
P. 18



Microline 9 x 8



16W/m

Microline

9 x 8



Min. L= 60mm (2.36")

Mounting options

With mounting U clip

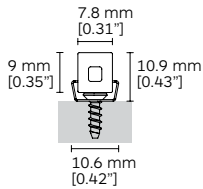
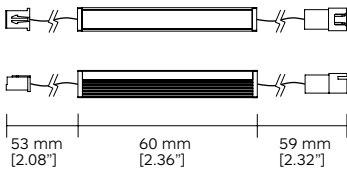

Max. L= 1995mm (78.54")

Increment: 45mm (1.77")

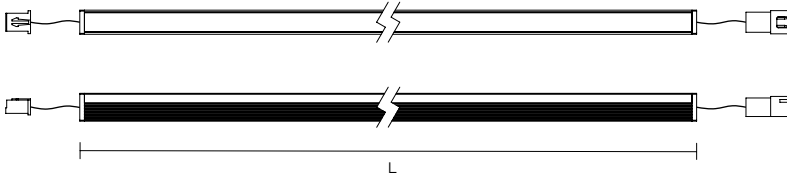

Code ordering example: **G 4 6 1 0 0 6 0 . 9 7 2 7 R D 0 0 1 0**

	Product code*	Length code***	Light Source	>CRI	CCT**	LED Power	Nominal Lumen	Diffuser	Driver Options	Finish
Microline 9 x 8	G461	0060	LED	97	27 2700K	16W/m	1420 lm/m	RD	00 No Driver	10 ■ Black
Min & Max. Length		1995			30 3000K					70 ■ Aluminium
					35 3500K					
					40 4000K					

Recommended Driver: Driver to be ordered separately. Work with 24VDC Constant Voltage LED Driver positioned remotely. Suggested Driver: 2V24D0, 2V24D1, 2V24DA. Please see page 83 for further information.

Notes:

* For complete code ordering information, please see page 91.

RD = Opal rigid diffuser. Ordering code: **RD**.

** For other CCT options, please contact us.

*** For complete list of length codes, please see page 68.

For related accessories, please see page 87.

For the most updated product information, please go to our website.

Microline

09



Body

Surface mounted LED system in extruded aluminium.
Available in different length configurations starting from 40mm with increment of 35mm.
Section diameter 9mm.

Mounting options:
Integrated magnets for easy installation.
L brackets.
U mounting clips.

*** Plastic free packaging.**

Accessories

Mounting accessories included.
Extension cable Art. 2D58 to be ordered separately.

Finish

Anodized black or aluminium finish.

LED sources

SMD.
CRI: 97 | R9: >90 | CCT: 2700K, 3000K, 3500K, 4000K.
3-Step MacAdam.
Other CRI and CCT options available on request.

Optic

Extra Wide Beam Angle.
Opal Diffuser (OD).
Lenticular Transparent Diffuser (TD).

Driver

Driver not included to be ordered separately.
Work with 24V Constant Voltage Driver positioned remotely.
See page 83 for further information.

Applications

Miniature linear light with a disappearing look delivers an homogenous and diffuse light effect, making it the ideal product for showcase and under cabinet illumination.
Application areas: Retail, cabinet displays, showcases, jewelry displays, residential, restaurants, museums.

Related Products

**Microline
Ø14**

P. 24



**Microline
Ø14 Chain**

P. 26



Microline Ø9



19W/m

Microline
Ø9



Min. L= 40mm (1.57")

Mounting options

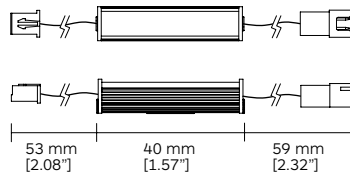

With magnet L bracket

With mounting U clip

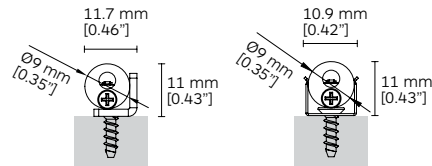

Max. L= 2105mm (82.87")

Increment: 35mm (1.37")

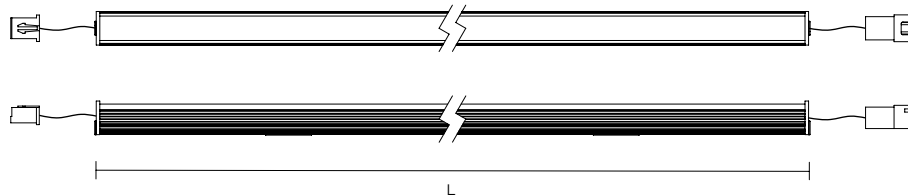

Code ordering example: **G 4 2 1 0 0 4 0 . 9 7 2 7 O D 0 0 1 0**

	Product code*	Length code***	Light Source	>CRI	CCT**	LED Power	Nominal Lumen	Diffuser	Driver Options	Finish
Microline Ø9	G421	0040	LED	97	27 2700K	19W/m	1694 lm/m	OD	00 No Driver	10 ■ Black
Min & Max. Length		2105			30 3000K			TD		70 ■ Aluminium
					35 3500K					
					40 4000K					

Recommended Driver: Driver to be ordered separately. Work with 24VDC Constant Voltage LED Driver positioned remotely. Suggested Driver: 2V24D0, 2V24D1, 2V24DA. Please see page 83 for further information.

Notes:

- * For complete code ordering information, please see page 91.
- ** For other CCT options, please contact us.
- *** For complete list of length codes, please see page 69.
- For related accessories, please see page 87.
- For the most updated product information, please go to our website.

OD = Opal diffuser. Ordering code: **OD**.
TD = Transparent lenticular diffuser. Ordering code: **TD**.

Microline

Ø14



Body

Surface mounted LED system in extruded aluminium.
Available in different length configurations starting from 35mm with increment of 30mm.
Section diameter 14mm.

Mounting options:
Integrated magnets for easy installation.
L brackets.
U mounting clips.

*** Plastic free packaging.**

Accessories

Mounting accessories included.
Extension cable Art. 2D58 to be ordered separately.

Finish

Anodized black or aluminium finish.

LED sources

SMD.
CRI: 97 | R9: >90 | CCT: 2700K, 3000K, 3500K, 4000K.
3-Step MacAdam.
Other CRI and CCT options available on request.

Optic

Extra Wide Beam Angle.
Opal Diffuser (OD).
Lenticular Transparent Diffuser (TD).
Opal Rigid Diffuser (RD).

Driver

Driver not included to be ordered separately.
Work with 24V Constant Voltage Driver positioned remotely.
See page 83 for further information.

Applications

Miniature linear light with a disappearing look delivers an homogenous and diffuse light effect, making it the ideal product for showcase and under cabinet illumination.
Application areas: Retail, cabinet displays, showcases, jewelry displays, residential, restaurants, museums.

Related Products

Microline

Ø9

P. 22



Microline

Ø14 Chain

P. 26



Microline

Spot

P. 34



Microline

Spot Chain

P. 36



Microline Ø14



16W/m | 20W/m | 31W/m

Microline
Ø14



Min. L= 35mm (1.37")

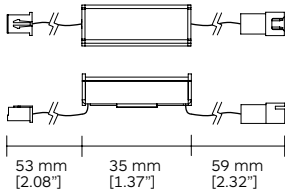

Mounting options

With magnet L bracket

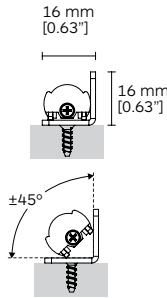

With mounting U clip

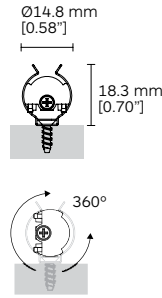

With magnet

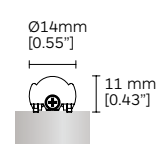

G422 with Max. L= 1925mm (75.79")
G445 & G420 with Max. L= 2105mm (82.87")

Increment: 30mm (1.18")

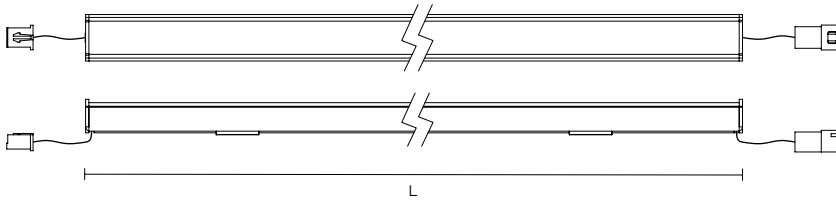

Code ordering example: **G 4 4 5 0 9 9 5 . 9 7 2 7 O D 0 0 1 0**

	Product code*	Length code***	Light Source	>CRI	CCT**	LED Power	Nominal Lumen	Diffuser	Driver Options	Finish
Microline Ø14 16W/m	G445	0995	LED	97	27 2700K	16W/m	1287lm/m	OD	00 No Driver	10 ■ Black
					30 3000K			TD		70 ■ Aluminium
Microline Ø14 20W/m	G420				35 3500K	20W/m	1815lm/m	RD		
					40 4000K					
Microline Ø14 31W/m	G422					31W/m	3152lm/m			

Recommended Driver: Driver to be ordered separately. Work with 24VDC Constant Voltage LED Driver positioned remotely. Suggested Driver: 2V24D0, 2V24D1, 2V24DA. Please see page 83 for further information.

Notes:

* For complete code ordering information, please see page 91.

** For other CCT options, Tuneable White / RGB / RGBW version, please contact us.

*** For complete list of length codes, please see pages 70 to 72.

For related accessories, please see page 87.

For the most updated product information, please go to our website.

OD = Opal diffuser. Ordering code: **OD**.

TD = Transparent lenticular diffuser. Ordering code: **TD**.

RD = Opal rigid diffuser. Ordering code: **RD**.

Microline

Ø14 Chain



Body

Surface mounted modular flexible LED system in extruded aluminium.
Available in different length configurations based on 65mm link with a 75mm increment.
Section 14mm diameter.

Mounting options:
Integrated magnets for easy installation.
L brackets.
U mounting clips.

*** Plastic free packaging.**

Accessories

Mounting accessories included.
Extension cable Art. 2D58 to be ordered separately.

Finish

Anodized black or aluminium finish.

LED sources

SMD.
CRI: 97 | R9: >90 | CCT: 2700K, 3000K, 3500K, 4000K.
3-Step MacAdam.
Other CRI and CCT options available on request.

Optic

Extra Wide Beam Angle.
Opal Diffuser (OD).
Lenticular Transparent Diffuser (TD).
Opal Rigid Diffuser (RD).

Driver

Driver not included to be ordered separately.
Work with 24V Constant Voltage Driver positioned remotely.
See page 83 for further information.

Applications

Curvaceous miniature linear light with a disappearing look delivers an homogenous and diffuse light effect. its peculiar structure allow it to fit in cove curved surfaces. Application areas: Retail, cabinet displays, showcases, jewelry displays, residential, restaurants, museums.

Related Products

**Microline
Ø9**

P. 22



**Microline
Ø14**

P. 24



**Microline
Spot**

P. 34



**Microline
Spot Chain**

P. 36



Microline Ø14 Chain



1.2W/Link | 1.9W/Link

Microline
Ø14 Chain



Min. L= 65mm (2.55"), 1 Link

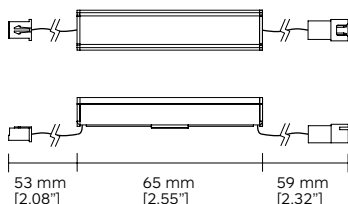

Mounting options

With magnet L bracket

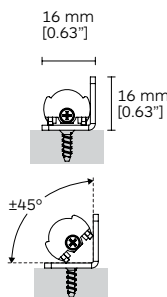

With mounting U clip

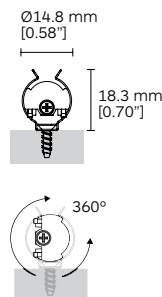

With magnet

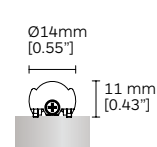

G435 with Max. L= 2990mm (117.71"), 40 Links
G436 with Max. L= 2390mm (94.09"), 32 Links

Increment: 75mm (2.95"), 1 Link

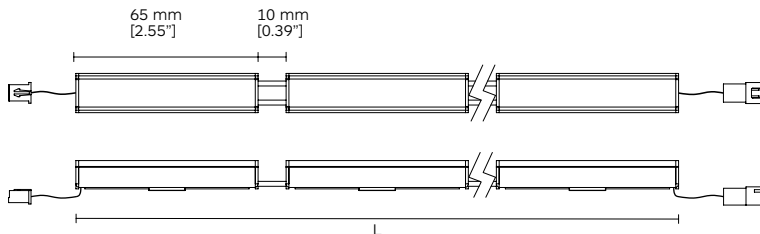

Code ordering example: **G 4 3 5 0 0 6 5 . 9 0 2 7 OD 0 0 1 0**

	Product code*	Length code***	Light Source	>CRI	CCT**	LED Power	Nominal Lumen	Diffuser	Driver Options	Finish	
Microline Ø14 Chain 1.2W/link	G435	0065	LED	97	27	2700K	1.2W/Link	118 lm/Link	OD	00 No Driver	10 ■ Black
					30	3000K					70 ■ Aluminium
Microline Ø14 Chain 1.9W/link	G436				35	3500K	1.9W/Link	164 lm/Link	RD		
					40	4000K					

Recommended Driver: Driver to be ordered separately. Work with 24VDC Constant Voltage LED Driver positioned remotely. Suggested Driver: 2V24D0, 2V24D1, 2V24DA. Please see page 83 for further information.

Notes:

* For complete code ordering information, please see page 91.

** For other CCT options, Tuneable White  / RGB / RGBW version, please contact us.

*** For complete list of length codes, please see pages 73 to 74.

For related accessories, please see page 87.

For the most updated product information, please go to our website.

OD = Opal diffuser. Ordering code; **OD**.

TD = Transparent lenticular diffuser. Ordering code; **TD**.

RD = Opal rigid diffuser. Ordering code; **RD**.

Microline

14 x 14



Body

Surface mounted LED system in extruded aluminium.
Deep regressed light source position.
Available in different length configurations starting from 35mm with increment of 30mm.
Section 14x14mm.

Mounting options:
Integrated magnets for easy installation.
L brackets.
U mounting clips.

*** Plastic free packaging.**

Accessories

Mounting accessories included.
Extension cable Art. 2D58 to be ordered separately.

Finish

Anodized black or aluminium finish.

LED sources

SMD.
CRI: 97 | R9: >90 | CCT: 2700K, 3000K, 3500K, 4000K.
3-Step MacAdam.
Other CRI and CCT options available on request.

Optic

Extra Wide Beam Angle.
Opal Diffuser (OD).
Lenticular Transparent Diffuser (TD).
Opal Rigid Diffuser (RD).

Driver

Driver not included to be ordered separately.
Work with 24V Constant Voltage Driver positioned remotely.
See page 84 for further information.

Applications

Miniature linear light with a disappearing look delivers an homogenous and diffuse light effect, making it the ideal product for showcase and under cabinet illumination.
Application areas: Retail, cabinet displays, showcases, jewelry displays, residential, restaurants, museums.

Related Products

**Microline
14 x 14
Chain**



P. 30

**Microline
14 x 14
Corner**



P. 32

Microline 14 x 14



20W/m

Microline
14 x 14

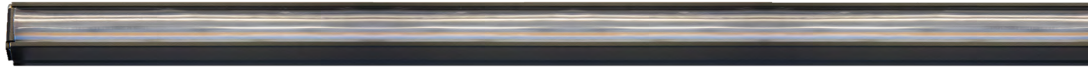

Min. L= 35mm (1.37")

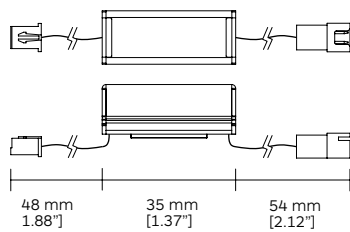

Mounting options

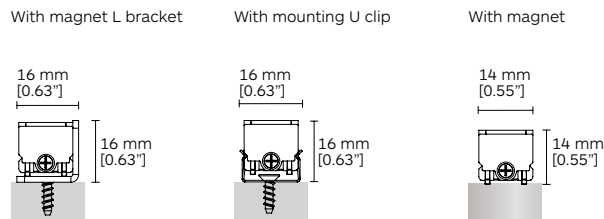

Max. L= 2015mm (79.33")

Increment: 30mm (1.18")

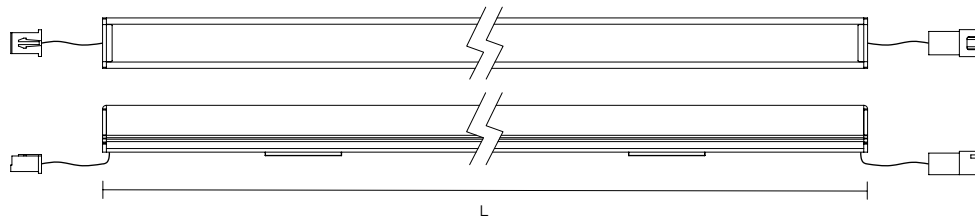

Code ordering example: **G 4 4 8 0 0 3 5 . 9 7 2 7 O D 0 0 1 0**

	Product code*	Length code***	Light Source	>CRI	CCT**	LED Power	Nominal Lumen	Diffuser	Driver Options	Finish
Microline 14 x 14 Min & Max. Length	G448	0035	LED	97	27 2700K	20W/m	1815 lm/m	OD	00 No Driver	10 ■ Black
					30 3000K			TD		70 ■ Aluminium
					35 3500K			RD		
					40 4000K					

Recommended Driver: Driver to be ordered separately. Work with 24VDC Constant Voltage LED Driver positioned remotely. Suggested Driver: 2V24D0, 2V24D1, 2V24DA. Please see page 84 for further information.

Notes:

* For complete code ordering information, please see page 91.

** For other CCT options, Tuneable White  / RGB / RGBW version, please contact us.

*** For complete list of length codes, please see page 75.

For related accessories, please see page 87.

For the most updated product information, please go to our website.

OD = Opal diffuser. Ordering code; **OD**.

TD = Transparent lenticular diffuser. Ordering code; **TD**.

RD = Opal rigid diffuser. Ordering code; **RD**.

Microline

14 x 14 Chain



Body

Surface mounted modular flexible LED system in extruded aluminium.
Available in different length configurations based on 65mm link with a 75mm increment.
Section 14x14mm.

Mounting options:
Integrated magnets for easy installation.
L brackets.
U mounting clips.

*** Plastic free packaging.**

Accessories

Mounting accessories included.
Extension cable Art. 2D58 to be ordered separately.

Finish

Anodized black or aluminium finish.

LED sources

SMD.
CRI: 97 | R9: >90 | CCT: 2700K, 3000K, 3500K, 4000K.
3-Step MacAdam.
Other CRI and CCT options available on request.

Optic

Extra Wide Beam Angle.
Opal Diffuser (OD).
Lenticular Transparent Diffuser (TD).
Opal Rigid Diffuser (RD).

Driver

Driver not included to be ordered separately.
Work with 24V Constant Voltage Driver positioned remotely.
See page 84 for further information.

Applications

Curvaceous miniature linear light with a disappearing look delivers an homogenous and diffuse light effect. its peculiar structure allow it to fit in cove curved surfaces.
Application areas: Retail, cabinet displays, showcases, jewelry displays, residential, restaurants, museums.

Related Products

Microline 14 x 14

P. 28



Microline 14 x 14 Corner

P. 32



Microline 14 x 14 Chain



1.2W/Link

Microline
14 x 14 Chain



Min. L= 65mm (2.55"), 1 Link

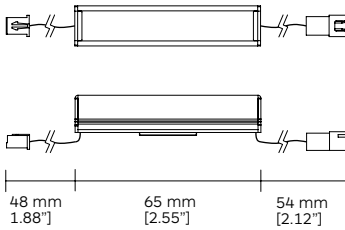

Mounting options

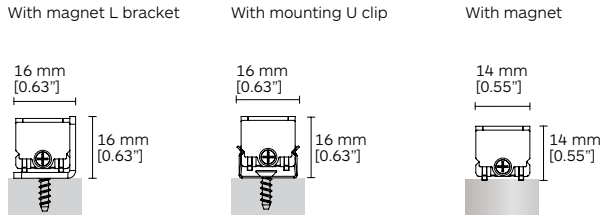

Max. L= 2990mm (117.71"), 40 Links

Increment: 75mm (2.95"), 1 Link

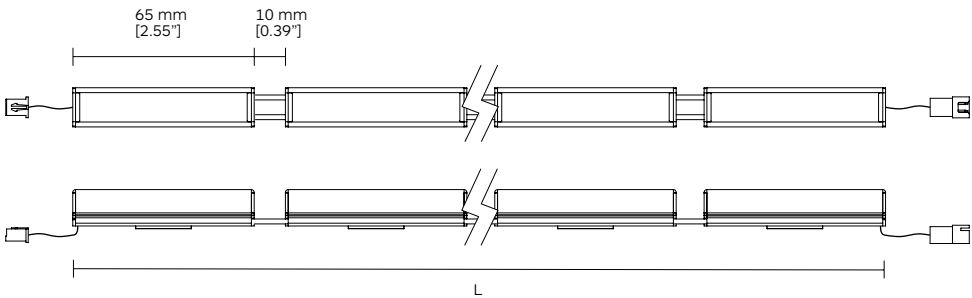

Code ordering example: **G 4 4 0 0 0 6 5 . 9 7 2 7 O D 0 0 1 0**

	Product code*	Length code***	Light Source	>CRI	CCT**	LED Power	Nominal Lumen	Diffuser	Driver Options	Finish
Microline 14 x 14 Chain	G440	0065	LED	97	27 2700K	1.2W/Link	118 lm/Link	OD	00 No Driver	10 ■ Black
Min & Max. Length		2990			30 3000K			TD		70 ■ Aluminium
					35 3500K			RD		
					40 4000K					

Recommended Driver: Driver to be ordered separately. Work with 24VDC Constant Voltage LED Driver positioned remotely. Suggested Driver: 2V24D0, 2V24D1, 2V24DA. Please see page 84 for further information.

Notes:

- * For complete code ordering information, please see page 91.
- ** For other CCT options, Tuneable White / RGB / RGBW version, please contact us.
- *** For complete list of length codes, please see page 76. For related accessories, please see page 87. For the most updated product information, please go to our website.

- OD = Opal diffuser. Ordering code: **OD**.
- TD = Transparent lenticular diffuser. Ordering code: **TD**.
- RD = Opal rigid diffuser. Ordering code: **RD**.

Microline

14 x 14 Corner



Body

Surface mounted LED system in extruded aluminium.
Specific shape to fit in corners.
Available in different length configurations starting from 35mm with increment of 30mm.
Triangular section 14x14mm.

Mounting options:
Integrated magnets for easy installation
L brackets.
U mounting clips.

*** Plastic free packaging.**

Accessories

Mounting accessories included.
Extension cable Art. 2D58 to be ordered separately.

Finish

Anodized black or aluminium finish.

LED sources

SMD.
CRI: 97 | R9: >90 | CCT: 2700K, 3000K, 3500K, 4000K.
3-Step MacAdam.
Other CRI and CCT options available on request.

Optic

Extra Wide Beam Angle.
Opal Rigid Diffuser (RD).

Driver

Driver not included to be ordered separately.
Work with 24V Constant Voltage Driver positioned remotely.
See page 84 for further information.

Applications

Miniature linear light for showcase and under cabinet diffuse illumination. Its peculiar shape allow it to fit in corners illuminating the surface from a 45 degree angle.
Application areas: Retail, cabinet displays, showcases, jewelry displays, residential, restaurants, museums.

Related Products

Microline 14 x 14

P. 28



Microline 14 x 14 Chain

P. 30



Microline 14 x 14 Corner



20W/m

Microline
14 x 14 Corner

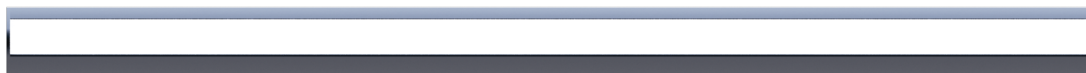

Min. L= 35mm (1.37")

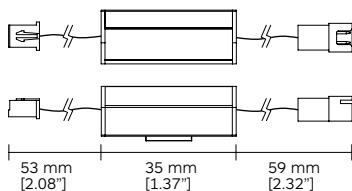

Mounting options

With magnet L bracket

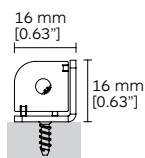

With magnet

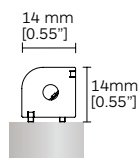

Max. L= 2015mm (79.33")

Increment: 30mm (1.18")

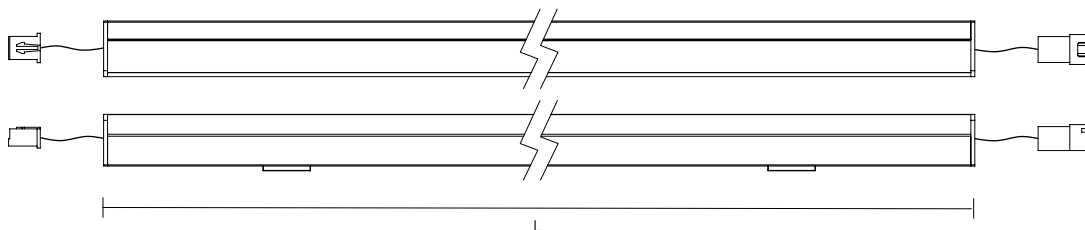

Code ordering example: **G 4 5 9 0 0 3 5 - 9 7 2 7 RD 0 0 1 0**

	Product code*	Length code***	Light Source	>CRI	CCT**	LED Power	Nominal Lumen	Diffuser	Driver Options	Finish
Microline 14 x 14 Corner	G459	0035	LED	97	27 2700K	20W/m	1815 lm/m	RD	00 No Driver	10 ■ Black
Min & Max. Length		2015			30 3000K					70 ■ Aluminium
					35 3500K					
					40 4000K					

Recommended Driver: Driver to be ordered separately. Work with 24VDC Constant Voltage LED Driver positioned remotely. Suggested Driver: 2V24D0, 2V24D1, 2V24DA. Please see page 84 for further information.

Notes:

* For complete code ordering information, please see page 91.

RD = Opal rigid diffuser. Ordering code: **RD**.

** For other CCT options, Tuneable White  / RGB / RGBW version, please contact us.

*** For complete list of length codes, please see page 77.

For related accessories, please see page 87.

For the most updated product information, please go to our website.

Microline

Spot



Body

Surface mounted LED system in extruded aluminium.
Available in different length configurations starting from 85mm with increment of 80mm.
Section 14x13mm.
Constant 40mm pitch between the LED.

Mounting options:
Integrated magnets for easy installation.
L brackets.
U mounting clips.

*** Plastic free packaging.**

Accessories

Mounting accessories included.
Extension cable Art. 2C47 to be ordered separately.

Finish

Anodized black or aluminium finish.

LED sources

Power LED. CRI: 97 | R9: >90 | CCT: 2700K, 3000K, 3500K, 4000K. 3-Step MacAdam
Other CRI and CCT options available on request.

Optic

Lens.
Beam angle: 21° / 29° / elliptical (22° x 47°).

Driver

Driver not included to be ordered separately.
Work with 700 mA Constant Current Driver positioned remotely.
See page 84 for further information.

Applications

Miniature linear light with a disappearing look emitting a spot light. Ideal solution for display showcase and under cabinet illumination.
Application areas: Retail, cabinet displays, showcases, jewelry displays, residential, restaurants, museums.

Related Products

**Microline
Spot Chain** 
P. 36

**Microline
Ø14** 
P. 24

**Microline
Ø14 Chain** 
P. 26

Microline Spot



Microline
Spot



Min. L= 85mm (3.34"), 2 LED

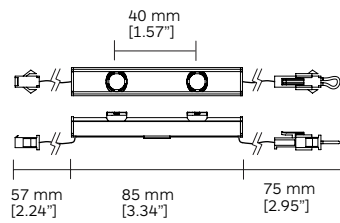

Mounting options

With magnet L bracket

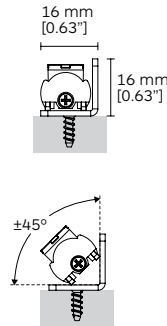

With mounting U clip

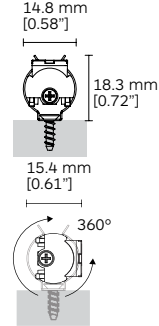

With magnet

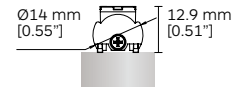

Max. L= 1285mm (50.59"), 32 LEDs

Increment: 80mm (3.14"), 2 LEDs

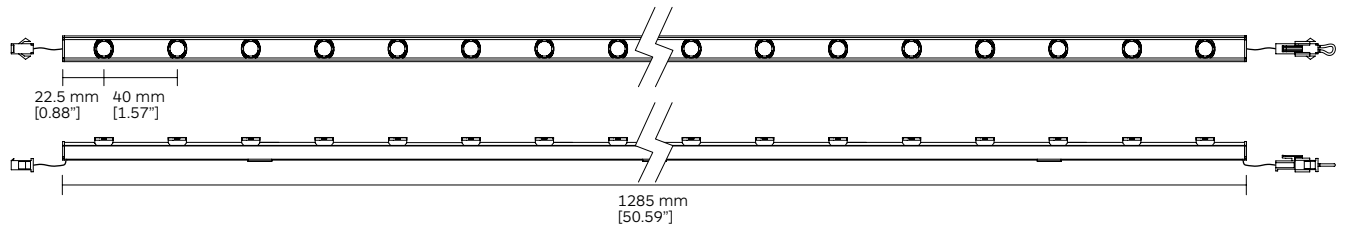

Code ordering example: **G 4 2 6 1 2 8 5 . 9 7 2 7 2 1 0 0 1 0**

	Product code*	Length code***	Light Source	>CRI	CCT**	LED Power	Nominal Lumen	Beam angle (BA°)	Driver Options	Finish
Microline Spot	G426	0085	LED	97	27 2700K	1W/LED	90 lm/LED	21 / 29 / EL	00 No Driver	10 ■ Black
Min & Max. Length		1285			30 3000K					70 ■ Aluminium
					35 3500K					
					40 4000K					

Recommended Driver: Driver to be ordered separately. Work with 700mA Constant Current LED Driver positioned remotely. Suggested Driver: 2C07D0, 2C07D1, 2C07DA. Please see page 84 for further information.

Notes:

- * For complete code ordering information, please see page 91.
 - ** For other CCT options, please contact us.
 - *** For complete list of length codes, please see page 78.
- For related accessories, please see page 87.
For the most updated product information, please go to our website.
EL = Elliptical Beam (22° x 47°).

Microline

Spot Chain



Body

Surface mounted modular system in extruded aluminium. Available in different length configurations based on 100mm modules (2 links per module) with a 110mm increment. Section 14x13mm. Its flexible structure maintain a constant 55mm pitch between the LED.

Mounting options:
Integrated magnets for easy installation
L brackets.
U mounting clips.

*** Plastic free packaging.**

Accessories

Mounting accessories included.
Extension cable Art. 2C47 to be ordered separately.

Finish

Anodized black or aluminium finish.

LED sources

Power LED.
CRI: 97 | R9: >90 | CCT: 2700K, 3000K, 3500K, 4000K.
3-Step MacAdam
Other CRI and CCT options available on request.

Optic

Lens.
Beam angle: 21° / 29° / elliptical (22° x 47°).

Driver

Driver not included to be ordered separately.
Work with 700 mA Constant Current Driver positioned remotely.
See page 85 for further information.

Applications

Miniature linear light with a disappearing look emitting a spot light. Ideal solution for display showcase and under cabinet illumination.
Application areas: Retail, cabinet displays, showcases, jewelry displays, residential, restaurants, museums.

Related Products

Microline Spot

P. 34



Microline Ø14

P. 24



Microline Ø14 Chain

P. 26



Microline Spot Chain



Microline
Spot Chain



Min. L= 100mm (3.93''), 2 LED, 2 Links

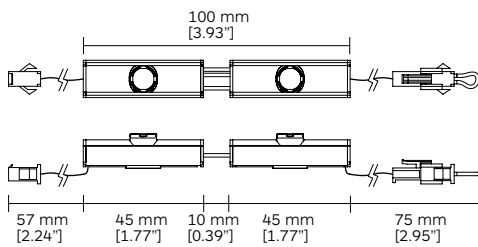

Mounting options

With magnet L bracket

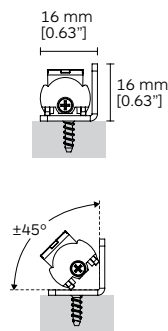

With mounting U clip

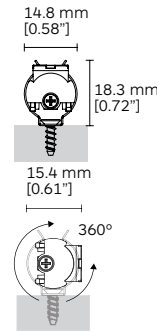

With magnet

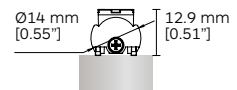

Max. L= 1750mm (68.89''), 32 LEDs, 32 Links

Increment: 110mm (4.33''), 2 LED, 2 Links

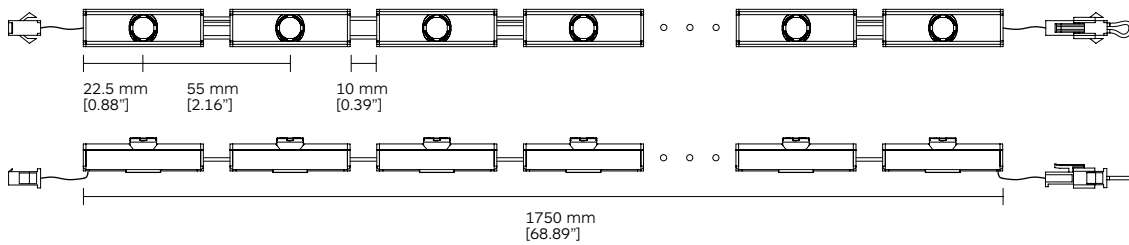

Code ordering example: **G 4 3 8 0 1 0 0 . 9 7 2 7 2 1 0 0 1 0**

	Product code*	Length code***	Light Source	>CRI	CCT**	LED Power	Nominal Lumen	Beam angle (BA°)	Driver Options	Finish
Microline Spot Chain	G438	0100	LED	97	27 2700K	1W/Link	90 lm/Link	21 / 29 / EL	00 No Driver	10 ■ Black
Min & Max. Length		1750			30 3000K 35 3500K 40 4000K					70 ■ Aluminium

Recommended Driver: Driver to be ordered separately. Work with 700mA Constant Current LED Driver positioned remotely. Suggested Driver: 2C07D0, 2C07D1, 2C07DA. Please see page 85 for further information.

Notes:

- * For complete code ordering information, please see page 91.
 - ** For other CCT options, please contact us.
 - *** For complete list of length codes, please see page 79.
- For related accessories, please see page 87.
For the most updated product information, please go to our website.
EL = Elliptical Beam (22° x 47°).

Mini Cobra Linealuce

Designed by Ponctuelle



Body

Surface mounted LED system in extruded aluminium.
Available in different length configurations starting from 65mm with increment of 60mm.
Section 14x14mm.
Constant 30mm pitch between the LED.

Mounting options:
Integrated magnets for easy installation.
L brackets.
U mounting clips.

*** Plastic free packaging.**

Accessories

Mounting accessories included.
Extension cable Art. 2C47 to be ordered separately.

Finish

Anodized black or aluminium finish.

LED sources

Power LED.
CRI: 97 | R9: >90 | CCT: 2700K, 3000K, 3500K, 4000K.
3-Step MacAdam.
Other CRI and CCT options available on request.

Optic

Lens.
Beam angle: 21° / 29° / elliptical (22° x 47°).

Driver

Driver not included to be ordered separately.
Work with 700 mA Constant Current Driver positioned remotely.
See page 85 for further information.

Applications

Ideal for indirect cove illumination, it creates a wall grazing effect for architectural surfaces. It is also a great pick also for display showcase illumination.
Application areas: Cove light, wallwash, residential, hospitality, restaurants, museums, display showcases.

Related Products

Mini Cobra Flex

P. 40



Mini Cobra Linealuce Louvre

P. 42



Mini Cobra Flex Louvre

P. 44



Mini Cobra Pro

P. 46



Mini Cobra Pro Louvre

P. 48



Mini Cobra Linealuce



Mini Cobra
Linealuce



Min. L= 65mm (2 x LED)

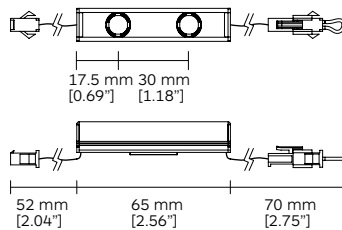

Mounting options

With magnet L bracket

With mounting U clip

With magnet

Accessories

Honeycomb Art. 2D97

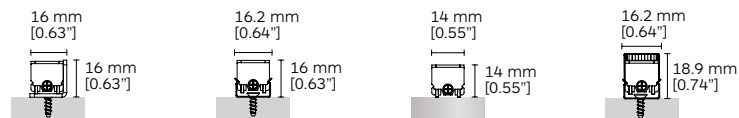

Max. L= 965mm (32 x LED)

Increment: 60mm (2.36"), 2 LEDs

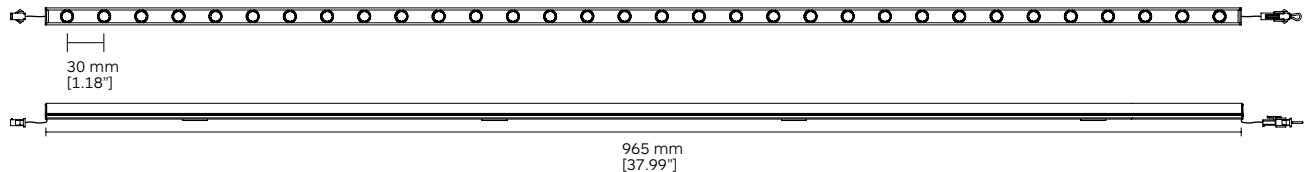

Available length codes

No. of LEDs	Voltage	LED Power	Length code	Length in mm	Length in inches	Nominal Lumen	No. of LEDs	Voltage	LED Power	Length code	Length in mm	Length in inches	Nominal Lumen
2	3.2V	2W	0065	65	2.55	180 lm	18	28.8V	18W	0545	545	21.45	1620 lm
4	6.4V	4W	0125	125	4.92	360 lm	20	32V	20W	0605	605	23.81	1800 lm
6	9.6V	6W	0185	185	7.28	540 lm	22	35.2V	22W	0665	665	26.18	1980 lm
8	12.8V	8W	0245	245	9.64	720 lm	24	38.4V	24W	0725	725	28.54	2160 lm
10	16V	10W	0305	305	12.00	900 lm	26	41.6V	26W	0785	785	30.90	2340 lm
12	19.2V	12W	0365	365	14.37	1080 lm	28	44.8V	28W	0845	845	33.26	2520 lm
14	22.4V	14W	0425	425	16.73	1260 lm	30	48V	30W	0905	905	35.62	2700 lm
16	25.6V	16W	0485	485	19.09	1440 lm	32	51.2V	32W	0965	965	37.99	2880 lm

Code ordering example: **G 4 5 1 0 0 6 5 - 9 7 2 7 2 1 0 0 1 0**

	Product code*	Length code**	Light Source	>CRI	CCT**	LED Power	Nominal Lumen	Beam angle (BA°)	Driver Options	Finish
Mini Cobra Linealuce	G451	0065	2 x LED	97	27 2700K	1W/LED	90 lm/LED	21 / 29 / EL	00 No Driver	10 ■ Black
Min & Max. Length		0965	32 x LED		30 3000K					70 ■ Aluminium
					35 3500K					
					40 4000K					

Recommended Driver: Driver to be ordered separately. Work with 700mA Constant Current LED Driver positioned remotely. Suggested Driver: 2C07D0, 2C07D1, 2C07DA. Please see page 85 for further information.

Notes:

* For complete code ordering information, please see page 91.

** For other CCT options, please contact us.

EL = Elliptical Beam (22° x 47°).

For related accessories, please see page 87.

For the most updated product information, please go to our website.

Mini Cobra Flex

Designed by Ponctuelle



Body

Surface mounted modular system in extruded aluminium. Available in different length configurations based on a 56mm link (2 LED per link) with a 60mm increment. Section 14x13mm. Its flexible structure maintain a constant 30mm pitch between the LED.

Mounting options:
Integrated magnets for easy installation.
L brackets.
U mounting clips.

*** Plastic free packaging.**

Accessories

Mounting accessories included.
Extension cable Art. 2C47 to be ordered separately.

Finish

Anodized black or aluminium finish.

LED sources

Power LED.
CRI: 97 | R9: >90 | CCT: 2700K, 3000K, 3500K, 4000K.
3-Step MacAdam.
Other CRI and CCT options available on request.

Optic

Lens.
Beam angle: 21° / 29° / elliptical (22° x 47°).

Driver

Driver not included to be ordered separately.
Work with 700 mA Constant Current Driver positioned remotely.
See page 85 for further information.

Applications

Ideal for indirect cove illumination, it creates a wall grazing effect for columns and curved architectural surfaces. It is also a great pick also for display showcase illumination. Application areas: Cove light, wallwash, residential, hospitality, restaurants, museums, display showcases.

Related Products

Mini Cobra Linealuce 
P. 38

Mini Cobra Linealuce Louvre 
P. 42

Mini Cobra Flex Louvre 
P. 44

Mini Cobra Pro 
P. 46

Mini Cobra Pro Louvre 
P. 48

Mini Cobra Flex



Mini Cobra Flex



Min. L= 56mm (2 x LED) 1 Link

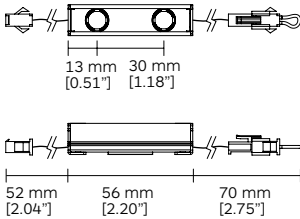

Mounting options

With magnet L bracket With mounting U clip With magnet

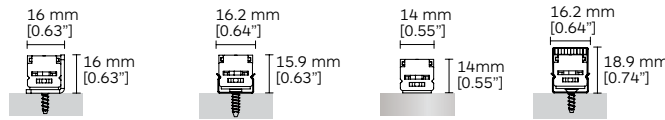

Accessories

Honeycomb Art. 2D97

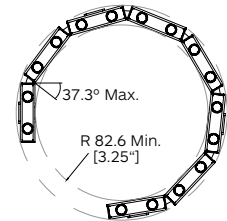

Max. L= 956mm (32 x LED) 16 Links

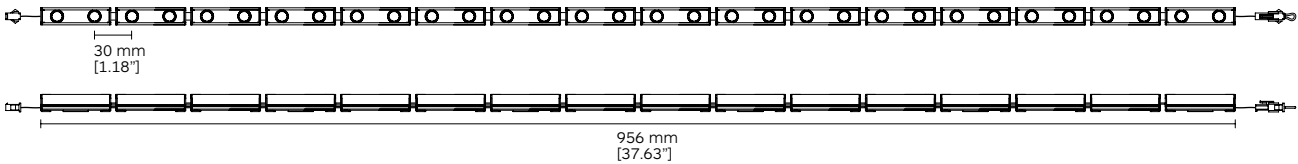

Available length codes

No. of Links	Voltage	LED Power	Length code	Length in mm	Length in inches	Nominal Lumen	No. of Links	Voltage	LED Power	Length code	Length in mm	Length in inches	Nominal Lumen
1	3.2V	2W	0056	56	2.20	180 lm	9	28.8V	18W	0536	536	21.10	1620 lm
2	6.4V	4W	0116	116	4.56	360 lm	10	32V	20W	0596	596	23.46	1800 lm
3	9.6V	6W	0176	176	6.92	540 lm	11	35.2V	22W	0656	656	25.82	1980 lm
4	12.5V	8W	0236	236	9.29	720 lm	12	38.4V	24W	0716	716	28.18	2160 lm
5	16V	10W	0296	296	11.65	900 lm	13	41.6V	26W	0776	776	30.55	2340 lm
6	19.2V	12W	0356	356	14.01	1080 lm	14	44.8V	28W	0836	836	32.91	2520 lm
7	22.4V	14W	0416	416	16.37	1260 lm	15	48V	30W	0896	896	35.27	2700 lm
8	25.6V	16W	0476	476	18.74	1440 lm	16	51.2V	32W	0956	956	37.63	2880 lm

Code ordering example: **G 4 3 0 0 0 5 6 - 9 7 2 7 2 1 0 0 1 0**

	Product code*	Length code	Light Source	>CRI	CCT**	LED Power	Nominal Lumen	Beam angle (BA°)	Driver Options	Finish
Mini Cobra Flex	G430	0056	2 x LED	97	27 2700K	1W/LED	90 lm/LED	21 / 29 / EL	00 No Driver	10 ■ Black
Min & Max. Length		0956	32 x LED		30 3000K					70 ■ Aluminium
					35 3500K					
					40 4000K					

Recommended Driver: Driver to be ordered separately. Work with 700mA Constant Current LED Driver positioned remotely. Suggested Driver: 2C07D0, 2C07D1, 2C07DA. Please see page 85 for further information.

Notes:

* For complete code ordering information, please see page 91.

** For other CCT options, please contact us.

EL = Elliptical Beam (22° x 47°).

For related accessories, please see page 87.

For the most updated product information, please go to our website.

Mini Cobra Linealuze Louvre

Designed by Ponctuelle



Body

Surface mounted LED system in extruded aluminium.
Available in different length configurations starting from 65mm with increment of 60mm.
Section 14x27mm.
Constant 30mm pitch between the LED.

Mounting options:
Integrated magnets for easy installation.
L brackets.
U mounting clips.
Integrated extruded aluminium louvre.

*** Plastic free packaging.**

Accessories

Mounting accessories included.
Extension cable Art. 2C47 to be ordered separately.

Finish

Anodized black or aluminium finish.

LED sources

Power LED.
CRI: 97 | R9: >90 | CCT: 2700K, 3000K, 3500K, 4000K.
3-Step MacAdam.
Other CRI and CCT options available on request.

Optic

Lens.
Beam angle: 21° / 29° / elliptical (22° x 47°).

Driver

Driver not included to be ordered separately.
Work with 700 mA Constant Current Driver positioned remotely.
See page 85 for further information.

Applications

Ideal for indirect cove illumination, it creates a wall grazing effect for architectural surfaces. It is also a great pick also for display showcase illumination.
Application areas: Cove light, wall grainger, residential, hospitality, restaurants, museums, display showcases.

Related Products

Mini Cobra Linealuze 
P. 38

Mini Cobra Flex 
P. 40

Mini Cobra Flex Louvre 
P. 44

Mini Cobra Pro 
P. 46

Mini Cobra Pro Louvre 
P. 48

Mini Cobra Linealuce Louvre



Mini Cobra
Linealuce
Louvre



Min. L= 65mm (2 x LED)

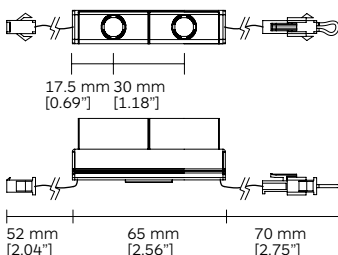

Mounting options

With magnet L bracket

With mounting U clip

With magnet

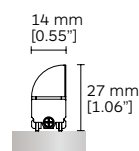
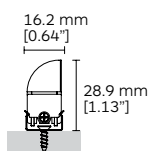
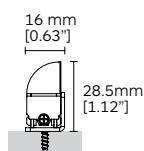

Max. L= 965mm (32 x LED)

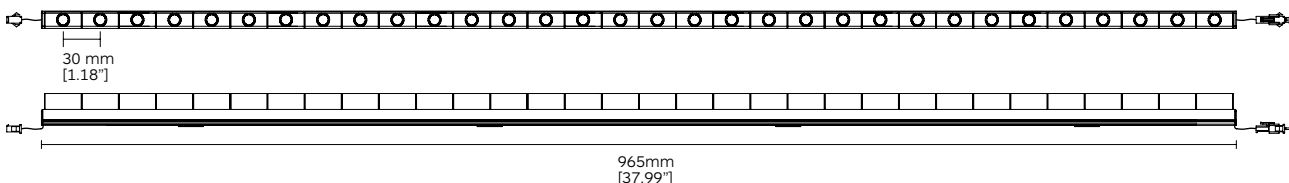

Available length codes

No. of LEDs	Voltage	LED Power	Length code	Length in mm	Length in inches	Nominal Lumen	No. of LEDs	Voltage	LED Power	Length code	Length in mm	Length in inches	Nominal Lumen
2	3.2V	2W	0065	65	2.55	180 lm	18	28.8V	18W	0545	545	21.45	1620 lm
4	6.4V	4W	0125	125	4.92	360 lm	20	32V	20W	0605	605	23.81	1800 lm
6	9.6V	6W	0185	185	7.28	540 lm	22	35.2V	22W	0665	665	26.18	1980 lm
8	12.8V	8W	0245	245	9.64	720 lm	24	38.4V	24W	0725	725	28.54	2160 lm
10	16V	10W	0305	305	12.00	900 lm	26	41.6V	26W	0785	785	30.90	2340 lm
12	19.2V	12W	0365	365	14.37	1080 lm	28	44.8V	28W	0845	845	33.26	2520 lm
14	22.4V	14W	0425	425	16.73	1260 lm	30	48V	30W	0905	905	35.62	2700 lm
16	25.6V	16W	0485	485	19.09	1440 lm	32	51.2V	32W	0965	965	37.99	2880 lm

Code ordering example: **G 4 5 2 0 0 6 5 - 9 7 2 7 2 1 0 0 1 0**

	Product code*	Length code	Light Source	>CRI	CCT**	LED Power	Nominal Lumen	Beam angle (BA°)	Driver Options	Finish
Mini Cobra Linealuce Louvre	G452	0065	2 x LED	97	27 2700K	1W/LED	90 lm/LED	21 / 29 / EL	00 No Driver	10 ■ Black
Min & Max. Length		0965	32 x LED		30 3000K					70 ■ Aluminium
					35 3500K					
					40 4000K					

Recommended Driver: Driver to be ordered separately. Work with 700mA Constant Current LED Driver positioned remotely. Suggested Driver: 2C07D0, 2C07D1, 2C07DA. Please see page 85 for further information.

Notes:

* For complete code ordering information, please see page 91.

** For other CCT options, please contact us.

EL = Elliptical Beam (22° x 47°).

For related accessories, please see page 87.

For the most updated product information, please go to our website.

Mini Cobra Flex Louvre

Designed by Ponctuelle



Body

Surface mounted modular system in extruded aluminium. Available in different length configurations based on a 56mm link (2 LED per link) with a 60mm increment. Section 15x27mm. Its flexible structure maintain a constant 30mm pitch between the LED.

Mounting options:
Integrated magnets for easy installation.
L brackets.
U mounting clips.
Integrated extruded aluminium louvre.

*** Plastic free packaging.**

Accessories

Mounting accessories included.
Extension cable Art. 2C47 to be ordered separately.

Finish

Anodized black or aluminium finish.

LED sources

Power LED.
CRI: 97 | R9: >90 | CCT: 2700K, 3000K, 3500K, 4000K.
3-Step MacAdam.
Other CRI and CCT options available on request.

Optic

Lens.
Beam angle: 21° / 29° / elliptical (22° x 47°).

Driver

Driver not included to be ordered separately.
Work with 700 mA Constant Current Driver positioned remotely.
See page 85 for further information.

Applications

Ideal for indirect cove illumination, it creates a wall grazing effect for columns and curved architectural surfaces. It is also a great pick also for display showcase illumination. Application areas: Cove light, wall grazing, residential, hospitality, restaurants, museums, display showcases.

Related Products

Mini Cobra Flex 
P. 40

Mini Cobra Linealuce 
P. 38

Mini Cobra Linealuce Louvre 
P. 42

Mini Cobra Pro 
P. 46

Mini Cobra Pro Louvre 
P. 48

Mini Cobra Flex Louvre



Mini Cobra
Flex Louvre



Min. L= 56mm (2 x LED) 1 Link

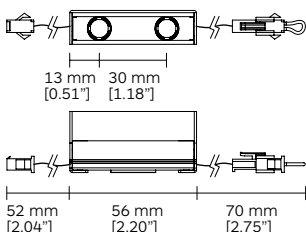

Mounting options

With magnet L bracket

With mounting U clip

With magnet

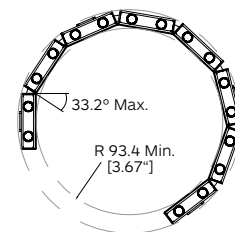
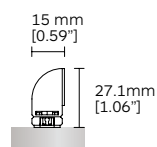
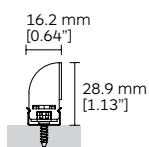
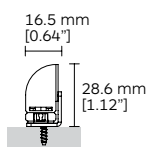

Max. L= 956mm (32 x LED) 16 Links

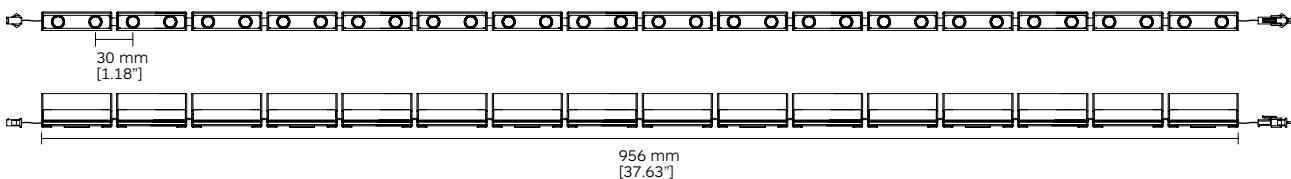

Available length codes

No. of Links	Voltage	LED Power	Length code	Length in mm	Length in inches	Nominal Lumen	No. of Links	Voltage	LED Power	Length code	Length in mm	Length in inches	Nominal Lumen
1	3.2V	2W	0056	56	2.20	180 lm	9	28.8V	18W	0536	536	21.10	1620 lm
2	6.4V	4W	0116	116	4.56	360 lm	10	32V	20W	0596	596	23.46	1800 lm
3	9.6V	6W	0176	176	6.92	540 lm	11	35.2V	22W	0656	656	25.82	1980 lm
4	12.5V	8W	0236	236	9.29	720 lm	12	38.4V	24W	0716	716	28.18	2160 lm
5	16V	10W	0296	296	11.65	900 lm	13	41.6V	26W	0776	776	30.55	2340 lm
6	19.2V	12W	0356	356	14.01	1080 lm	14	44.8V	28W	0836	836	32.91	2520 lm
7	22.4V	14W	0416	416	16.37	1260 lm	15	48V	30W	0896	896	35.27	2700 lm
8	25.6V	16W	0476	476	18.74	1440 lm	16	51.2V	32W	0956	956	37.63	2880 lm

Code ordering example: **G 4 3 9 0 0 5 6 . 9 7 2 7 2 1 0 0 1 0**

	Product code*	Length code	Light Source	>CRI	CCT**	LED Power	Nominal Lumen	Beam angle (BA°)	Driver Options	Finish
Mini Cobra Flex Louvre	G439	0056	2 x LED	97	27 2700K	1W/LED	90 lm/LED	21 / 29 / EL	00 No Driver	10 ■ Black
Min & Max. Length		0956	32 x LED		30 3000K					70 ■ Aluminium
					35 3500K					
					40 4000K					

Recommended Driver: Driver to be ordered separately. Work with 700mA Constant Current LED Driver positioned remotely. Suggested Driver: 2C07D0, 2C07D1, 2C07DA. Please see page 85 for further information.

Notes:

* For complete code ordering information, please see page 91.

** For other CCT options, please contact us.

EL = Elliptical Beam (22° x 47°).

For related accessories, please see page 87.

For the most updated product information, please go to our website.

Mini Cobra Pro



Body

Surface mounted modular system in die cast aluminium. Available in different length configurations based on a 62mm link (2 LED per link) with a 60mm increment. Section 15x17mm. Its flexible structure maintain a constant 30mm pitch between the LED.

Mounting options:
integrated magnets for easy installation.
L brackets included.

*** Plastic free packaging.**

Accessories

Mounting accessories not included.
Extension cable Art. 2C47 to be ordered separately.

Finish

Powder coat in black colour.

LED sources

Power LED.
CRI: 97 | R9: >90 | CCT: 2700K, 3000K, 3500K, 4000K.
3-Step MacAdam.
Other CRI and CCT options available on request.

Optic

Lens.
Beam angle: 21° / 31° / elliptical (22° x 44°).

Driver

Driver not included to be ordered separately.
Work with 700 mA Constant Current Driver positioned remotely.
See page 86 for further information.

Applications

Ideal for indirect cove illumination, it creates a wall grazing effect for columns and curved architectural surfaces. It is also a great pick also for display showcase illumination. Application areas: Cove light, wallwash, residential, hospitality, restaurants, museums, display showcases.

Related Products

Mini Cobra Linealuce 
P. 38

Mini Cobra Flex 
P. 40

Mini Cobra Linealuce Louvre 
P. 42

Mini Cobra Flex Louvre 
P. 44

Mini Cobra Pro Louvre 
P. 48

Mini Cobra Pro



Mini Cobra
Pro



Min. L= 62mm (2 x LED) 1 Link

Mounting options

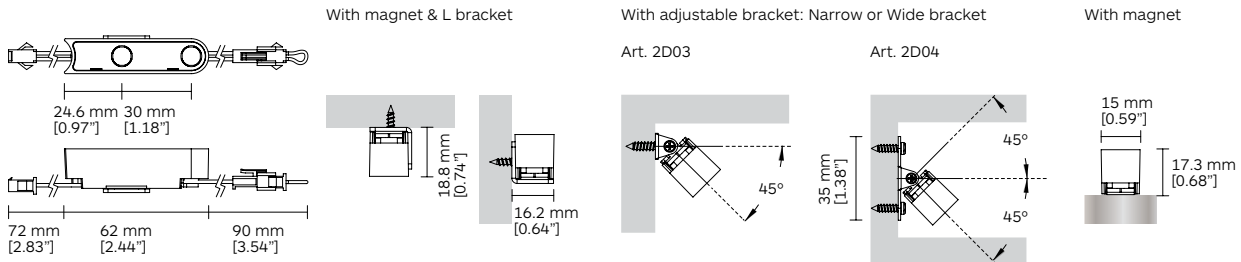

Max. L= 962mm (32 x LED) 16 Links

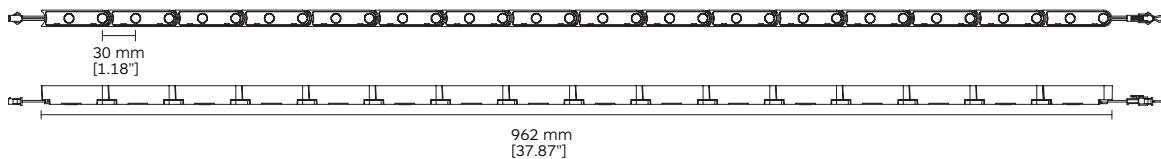

Available length codes

No. of Links	Voltage	LED Power	Length code	Length in mm	Length in inches	Nominal Lumen	No. of Links	Voltage	LED Power	Length code	Length in mm	Length in inches	Nominal Lumen
1	3.2V	2W	0062	62	2.44	180 lm	9	28.8V	18W	0542	542	21.33	1620 lm
2	6.4V	4W	0122	122	4.80	360 lm	10	32V	20W	0602	606	23.70	1800 lm
3	9.6V	6W	0182	182	7.16	540 lm	11	35.2V	22W	0662	662	26.06	1980 lm
4	12.5V	8W	0242	242	9.52	720 lm	12	38.4V	24W	0722	722	28.42	2160 lm
5	16V	10W	0302	302	11.88	900 lm	13	41.6V	26W	0782	782	30.78	2340 lm
6	19.2V	12W	0362	362	14.25	1080 lm	14	44.8V	28W	0842	842	33.14	2520 lm
7	22.4V	14W	0422	422	16.61	1260 lm	15	48V	30W	0902	902	35.51	2700 lm
8	25.6V	16W	0482	482	18.97	1440 lm	16	51.2V	32W	0962	962	37.87	2880 lm

Code ordering example: **G 4 6 2 0 0 6 2 . 9 7 2 7 2 1 0 0 1 0**

	Product code*	Length code***	Light Source	>CRI	CCT**	LED Power	Nominal Lumen	Beam angle (BA°)	Driver Options	Finish
Mini Cobra Pro	G462	0062	2 x LED	97	27 2700K	1W/LED	90 lm/LED	21 / 31 / EL	00 No Driver	10 ■ Black
Min & Max. Length		0962	32 x LED	30	3000K					
				35	3500K					
				40	4000K					

Recommended Driver: Driver to be ordered separately. Work with 700mA Constant Current LED Driver positioned remotely. Suggested Driver: 2C07D0, 2C07D1, 2C07DA. Please see page 86 for further information.

Notes:

- * For complete code ordering information, please see page 91.
- ** For other CCT options, please contact us.
- EL** = Elliptical Beam (22° x 44°).
- For related accessories, please see page 87.
- For the most updated product information, please go to our website.

Mini Cobra Pro Louvre



Body

Surface mounted modular system in die cast aluminium. Available in different length configurations based on a 62mm link (2 LED per link) with a 60mm increment. Section 15x30mm. Its flexible structure maintain a constant 30mm pitch between the LED.

Mounting options:
integrated magnets for easy installation.
L brackets included.
Integrated plastic louvre.

*** Plastic free packaging.**

Accessories

Mounting accessories not included.
Extension cable Art. 2C47 to be ordered separately.

Finish

Powder coat in black colour.

LED sources

Power LED.
CRI: 97 | R9: >90 | CCT: 2700K, 3000K, 3500K, 4000K.
3-Step MacAdam.
Other CRI and CCT options available on request.

Optic

Lens.
Beam angle: 21° / 31° / elliptical (22° x 44°).

Driver

Driver not included to be ordered separately.
Work with 700 mA Constant Current Driver positioned remotely.
See page 86 for further information.

Applications

Ideal for indirect cove illumination, it creates a wall grazing effect for columns and curved architectural surfaces. It is also a great pick also for display showcase illumination. Application areas: Cove light, wallwash, residential, hospitality, restaurants, museums, display showcases.

Related Products

Mini Cobra Linealuce 
P. 38

Mini Cobra Flex 
P. 40

Mini Cobra Linealuce Louvre 
P. 42

Mini Cobra Flex Louvre 
P. 44

Mini Cobra Pro 
P. 46

Mini Cobra Pro Louvre



Mini Cobra
Pro Louvre



Min. L= 62mm (2 x LED) 1 Link

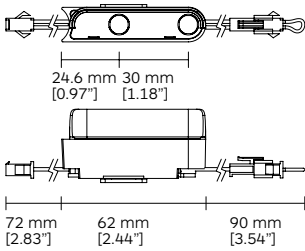

Mounting options

With magnet & L bracket

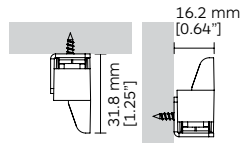

With adjustable bracket: Narrow or Wide bracket

Art. 2D03

Art. 2D04

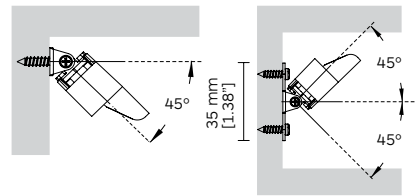

With magnet

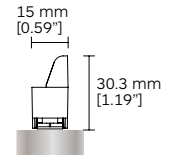

Max. L= 962mm (32 x LED) 16 Links

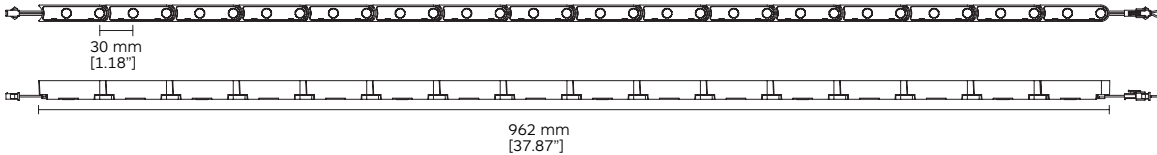

Available length codes

No. of Links	Voltage	LED Power	Length code	Length in mm	Length in inches	Nominal Lumen	No. of Links	Voltage	LED Power	Length code	Length in mm	Length in inches	Nominal Lumen
1	3.2V	2W	0062	62	2.44	180 lm	9	28.8V	18W	0542	542	21.33	1620 lm
2	6.4V	4W	0122	122	4.80	360 lm	10	32V	20W	0602	606	23.70	1800 lm
3	9.6V	6W	0182	182	7.16	540 lm	11	35.2V	22W	0662	662	26.06	1980 lm
4	12.5V	8W	0242	242	9.52	720 lm	12	38.4V	24W	0722	722	28.42	2160 lm
5	16V	10W	0302	302	11.88	900 lm	13	41.6V	26W	0782	782	30.78	2340 lm
6	19.2V	12W	0362	362	14.25	1080 lm	14	44.8V	28W	0842	842	33.14	2520 lm
7	22.4V	14W	0422	422	16.61	1260 lm	15	48V	30W	0902	902	35.51	2700 lm
8	25.6V	16W	0482	482	18.97	1440 lm	16	51.2V	32W	0962	962	37.87	2880 lm

Code ordering example: **G 4 6 3 0 0 6 2 - 9 7 2 7 2 1 0 0 1 0**

	Product code*	Length code***	Light Source	>CRI	CCT**	LED Power	Nominal Lumen	Beam angle (BA°)	Driver Options	Finish
Mini Cobra Pro Louvre	G463	0062	2 x LED	97	27 2700K	1W/LED	90 lm/LED	21 / 31 / EL	00 No Driver	10 ■ Black
Min & Max. Length		0962	32 x LED		30 3000K					
					35 3500K					
					40 4000K					

Recommended Driver: Driver to be ordered separately. Work with 700mA Constant Current LED Driver positioned remotely. Suggested Driver: 2C07D0, 2C07D1, 2C07DA. Please see page 86 for further information.

Notes:

* For complete code ordering information, please see page 91.

** For other CCT options, please contact us.

EL = Elliptical Beam (22° x 44°).

For related accessories, please see page 87.

For the most updated product information, please go to our website.

Cobra Linealuce

Designed by Ponctuelle



Body

Surface mounted LED system in extruded aluminium.
Available in different length configurations starting from 120mm with increment of 120mm.
Section 30.4x33.7mm.
Constant 30mm pitch between the LED.

Mounting options:
U mounting clips.

*** Plastic free packaging.**

Accessories

Honeycomb Art. 2D88.
Mounting accessories included.
Extension cable Art. 2C47 to be ordered separately.

Finish

Anodized black finish.

LED sources

Power LED.
CRI: 90 | R9: >50 | CCT: 2700K, 3000K, 3500K, 4000K.
3-Step MacAdam.
Other CRI and CCT options available on request.

Optic

Lens.
Beam angle: 17° / 29° / elliptical (15° x 50°).
Wallwasher optics.

Driver

Driver not included to be ordered separately.
Work with 1050 mA Constant Current Driver positioned remotely.
See page 86 for further information.

Applications

Ideal for indirect cove illumination, it creates a wall grazing effect for columns and curved architectural surfaces.
The constant pitch between its LED, insures a continuous illumination without any shadows or dark areas.
Application areas: Cove light, wallwash, residential, hospitality, restaurants, museums.

Related Products

Cobra Flex
P. 52 

Cobra Linealuce Louvre
P. 54 

Cobra Flex Louvre
P. 56 

Cobra Pro IP66
P. 58 - 60 



Cobra Linealuce



Cobra Linealuce



Min. L= 120mm (4 x LED)

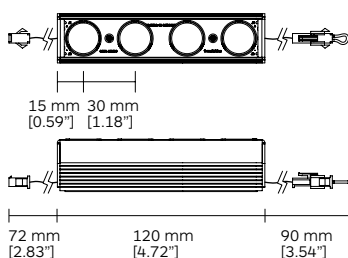

Mounting options

With mounting U clip

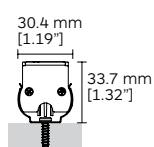

Accessories

Honeycomb Art. 2D88

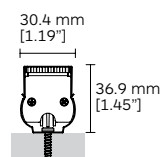

Max. L= 960 mm (32 x LED)

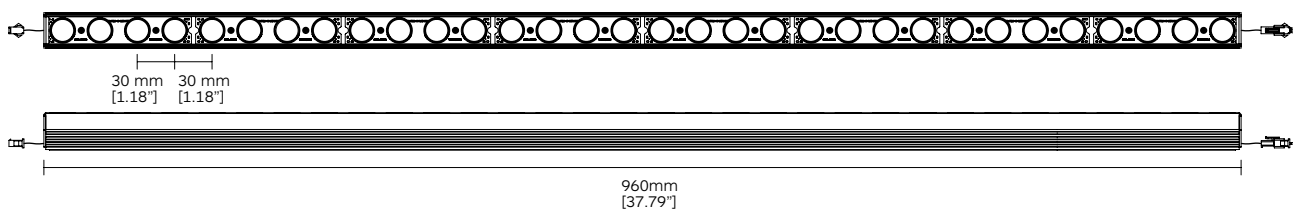

Available length codes

No. of LEDs	Voltage	LED Power	Length code	Length in mm	Length in inches	Nominal Lumen	No. of LEDs	Voltage	LED Power	Length code	Length in mm	Length in inches	Nominal Lumen
4	6.6V	6.3W	0120	120	4.72	732 lm	20	33V	31.5W	0600	600	23.62	3660 lm
8	13.2V	12.6W	0240	240	9.44	1464 lm	24	39.6V	37.8W	0720	720	28.34	4392 lm
12	19.8V	18.9W	0360	360	14.17	2196 lm	28	46.2V	44.1W	0840	840	33.04	5124 lm
16	26.4V	25.2W	0480	480	18.89	2928 lm	32	52.8V	50.4W	0960	960	37.79	5856 lm

Code ordering example: **G 4 4 9 0 1 2 0 - 9 0 2 7 1 0 0 0 1 0**

	Product code*	Length code	Light Source	>CRI	CCT**	LED Power	Nominal Lumen	Beam angle (BA°)	Driver Options	Finish
Cobra Linealuce	G449	0120	4 x LED	90	27 2700K	1.5W/LED	183lm/LED	10 / 17 / 29 / EL / WW	00 No Driver	10 ■ Black
Min & Max. Length		0960	32 x LED		30 3000K 35 3500K 40 4000K					

Recommended Driver: Driver to be ordered separately. Work with 1050mA Constant Current LED Driver positioned remotely. Suggested Driver: 2C02D0, 2C02D1, 2C02DA. Please see page 86 for further information.

Notes:

* For complete code ordering information, please see page 91.

** For other CCT options, Tuneable White  / RGB / RGBW version, please contact us.

EL = Elliptical Beam (15° x 50°). **WW** = Wallwasher optics.

For related accessories, please see page 87.

For the most updated product information, please go to our website.

Cobra Flex

Designed by Ponctuelle



Body

Surface mounted modular system in extruded aluminium. Available in different length configurations based on a 54mm link (2 LED per link) with a 60mm increment. Section 31.9x32.6mm. Its flexible structure maintain a constant 30mm pitch between the LED.

Mounting options:
U mounting clips.

*** Plastic free packaging.**

Accessories

Honeycomb Art. 2D88.
Mounting accessories included.
Extension cable Art. 2C47 to be ordered separately.

Finish

Anodized black finish.

LED sources

Power LED. CRI: 90 | R9: >50 | CCT: 2700K, 3000K, 3500K, 4000K.
3-Step MacAdam.
Other CRI and CCT options available on request.

Optic

Lens.
Beam angle: 17° / 29° / elliptical (15° x 50°).
Wallwasher optics.

Driver

Driver not included to be ordered separately.
Work with 1050 mA Constant Current Driver positioned remotely.
See page 86 for further information.

Applications

Ideal for indirect cove illumination, it creates a wall grazing effect for columns and curved architectonic surfaces. Its flexible structure maintain a constant pitch between LED, insuring a continuous illumination without any shadows or dark areas. Application areas: Cove light, wallwash, residential, hospitality, restaurants, museums.

Related Products

Cobra Linealuce 
P. 50

Cobra Flex Louvre 
P. 56

Cobra Linealuce Louvre 
P. 54

Cobra Pro IP66 
P. 58 - 60



Cobra Flex



Cobra
Flex



Min. L= 54mm (2 x LED) 1 Link

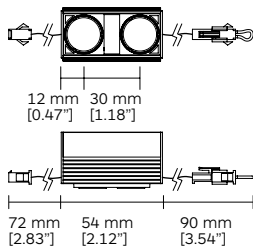

Mounting options

With mounting U clip

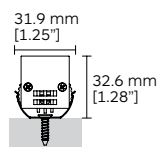

Accessories

Honeycomb Art. 2D88

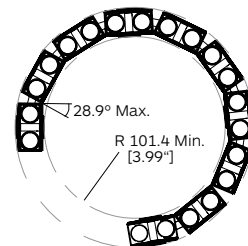
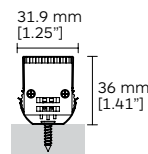

Max. L= 954mm (32 x LED) 16 Links

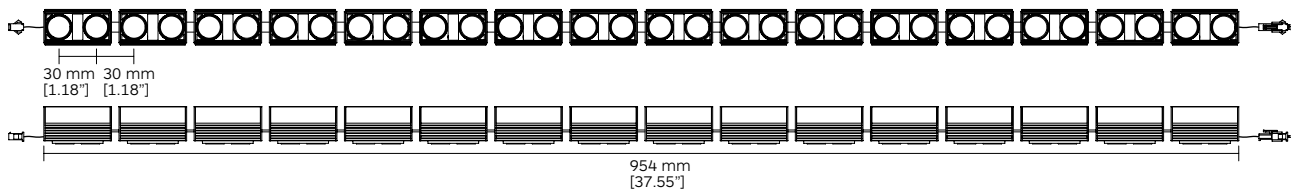

Available length codes

No. of Links	Voltage	LED Power	Length code	Length in mm	Length in inches	Nominal Lumen	No. of Links	Voltage	LED Power	Length code	Length in mm	Length in inches	Nominal Lumen
1	3.3V	3.1W	0054	54	2.12	366 lm	9	29.7V	28.3W	0534	534	21.02	3294 lm
2	6.6V	6.3W	0114	114	4.48	732 lm	10	33V	31.5W	0594	594	23.38	3660 lm
3	9.9V	9.4W	0174	174	6.85	1098 lm	11	36.3V	34.6W	0654	654	25.74	4026 lm
4	13.2V	12.6W	0234	234	9.21	1464 lm	12	39.6V	37.8W	0714	714	28.11	4392 lm
5	16.5V	15.7W	0294	294	11.57	1830 lm	13	42.9V	40.9W	0774	774	30.47	4758 lm
6	19.8V	18.9W	0354	354	13.93	2196 lm	14	46.2V	44.1W	0834	834	32.83	5124 lm
7	23.1V	22W	0414	414	16.29	2562 lm	15	49.5V	47.2W	0894	894	35.19	5490 lm
8	26.4V	25.2W	0474	474	18.66	2928 lm	16	52.8V	50.4W	0954	954	37.55	5856 lm

Code ordering example: **G 4 0 1 0 0 5 4 . 9 0 2 7 1 0 0 0 1 0**

	Product code*	Length code	Light Source	>CRI	CCT**	LED Power	Nominal Lumen	Beam angle (BA°)	Driver Options	Finish	
Cobra Flex	G401	0054	2 x LED	90	27	2700K	1.5W/LED	183lm/LED	10 / 17 / 29 / EL / WW	00 No Driver	10 ■ Black
Min & Max. Length		0954	32 x LED		30	3000K					
					35	3500K					
					40	4000K					

Recommended Driver: Driver to be ordered separately. Work with 1050mA Constant Current LED Driver positioned remotely. Suggested Driver: 2C02D0, 2C02D1, 2C02DA. Please see page 86 for further information.

Notes:

- * For complete code ordering information, please see page 91.
- ** For other CCT options, Tuneable White / RGB / RGBW version, please contact us.
- EL** = Elliptical Beam (15° x 50°). **WW** = Wallwasher optics.
- For related accessories, please see page 87.
- For the most updated product information, please go to our website.

Cobra Linealuce Louvre

Designed by Ponctuelle



Body

Surface mounted LED system in extruded aluminium. Available in different length configurations starting from 120mm with increment of 120mm. Section 30.4x46.4mm. Constant 30mm pitch between the LED.

Mounting options:
U mounting clips.
Integrated extruded alluminium louvre.

*** Plastic free packaging.**

Accessories

Mounting accessories included.
Extension cable Art. 2C47 to be ordered separately.

Finish

Anodized black finish.

LED sources

Power LED. CRI: 90 | R9: >50 | CCT: 2700K, 3000K, 3500K, 4000K.
3-Step MacAdam.
Other CRI and CCT options available on request.

Optic

Lens.
Beam angle: 17° / 29° / elliptical (15° x 50°).
Wallwasher optics.

Driver

Driver not included to be ordered separately.
Work with 1050 mA Constant Current Driver positioned remotely.
See page 86 for further information.

Applications

Ideal for indirect cove illumination, it creates a wall grazing effect for columns and curved architectonic surfaces. The constant pitch between its LED, insures a continuous illumination without any shadows or dark areas.
Application areas: Cove light, wall grazing, residential, hospitality, restaurants, museums.

Related Products

Cobra Linealuce

P. 50



Cobra Flex

P. 52



Cobra Flex Louvre

P. 56



Cobra Pro IP66

P. 58 - 60



Cobra Linealuce Louvre



Cobra
Linealuce
Louvre



Min. L= 120mm (4 x LED)

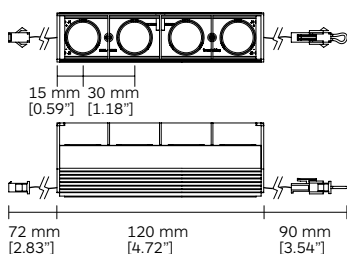

Mounting options

With mounting U clip

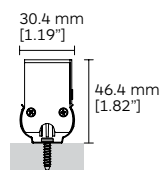

Max. L= 960 mm (32 x LED)

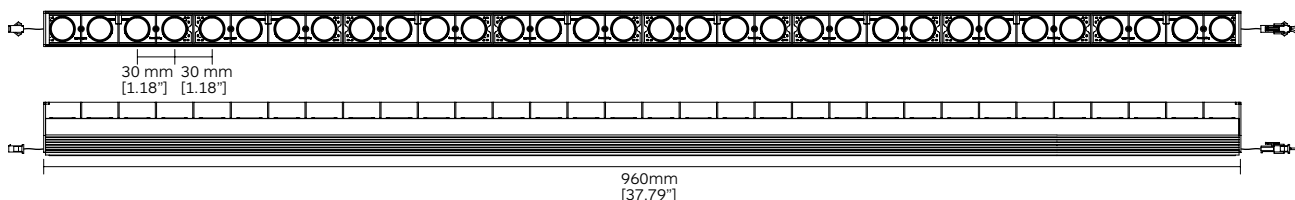

Available length codes

No. of LEDs	Voltage	LED Power	Length code	Length in mm	Length in inches	Nominal Lumen	No. of LEDs	Voltage	LED Power	Length code	Length in mm	Length in inches	Nominal Lumen
4	6.6V	6.3W	0120	120	4.72	732 lm	20	33V	31.5W	0600	600	23.62	3660 lm
8	13.2V	12.6W	0240	240	9.44	1464 lm	24	39.6V	37.8W	0720	720	28.34	4392 lm
12	19.8V	18.9W	0360	360	14.17	2196 lm	28	46.2V	44.1W	0840	840	33.04	5124 lm
16	26.4V	25.2W	0480	480	18.89	2928 lm	32	52.8V	50.4W	0960	960	37.79	5856 lm

Code ordering example: **G 4 5 0 0 1 2 0 . 9 0 2 7 1 0 0 0 1 0**

	Product code*	Length code	Light Source	>CRI	CCT**	LED Power	Nominal Lumen	Beam angle (BA°)	Driver Options	Finish
Cobra Linealuce Louvre	G450	0120	4 x LED	90	27 2700K	1.5W/LED	183lm/LED	10 / 17 / 29 / EL / WW	00 No Driver	10 ■ Black
Min & Max. Length		0960	32 x LED	30	3000K					
				35	3500K					
				40	4000K					

Recommended Driver: Driver to be ordered separately. Work with 1050mA Constant Current LED Driver positioned remotely. Suggested Driver: 2C02D0, 2C02D1, 2C02DA. Please see page 86 for further information.

Notes:

* For complete code ordering information, please see page 91.

** For other CCT options, Tuneable White  / RGB / RGBW version, please contact us.

EL = Elliptical Beam (15° x 50°). **WW** = Wallwasher optics.

For related accessories, please see page 87.

For the most updated product information, please go to our website.

Cobra Flex Louvre

Designed by Ponctuelle



Body

Surface mounted modular system in extruded aluminium. Available in different length configurations based on a 54mm link (2 LED per link) with a 60mm increment. Section 31.9x45.4mm. Its flexible structure maintain a constant 30mm pitch between the LED.

Mounting options:
U mounting clips.
Integrated extruded aluminium louvre.

*** Plastic free packaging.**

Accessories

Mounting accessories included.
Extension cable Art. 2C47 to be ordered separately.

Finish

Anodized black finish.

LED sources

Power LED. CRI: 90 | R9: >50 | CCT: 2700K, 3000K, 3500K, 4000K.
3-Step MacAdam.
Other CRI and CCT options available on request.

Optic

Lens.
Beam angle: 17° / 29° / elliptical (15° x 50°).
Wallwasher optics.

Driver

Driver not included to be ordered separately.
Work with 1050 mA Constant Current Driver positioned remotely.
See page 87 for further information.

Applications

Ideal for indirect cove illumination, it creates a wall grazing effect for columns and curved architectural surfaces. Its flexible structure maintain a constant pitch between LED, insuring a continuous illumination without any shadows or dark areas. Application areas: Cove light, wallwash, residential, hospitality, restaurants, museums.

Related Products

Cobra Linealuce 
P. 50

Cobra Flex 
P. 52

Cobra Linealuce Louvre 
P. 54

Cobra Pro IP66 
P. 58 - 60



Cobra Flex Louvre



Cobra
Flex Louvre



Min. L= 54mm (2 x LED) 1 Link

Mounting options

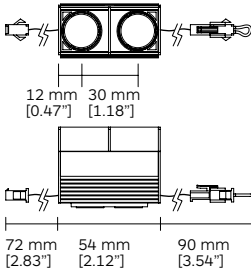

With mounting U clip

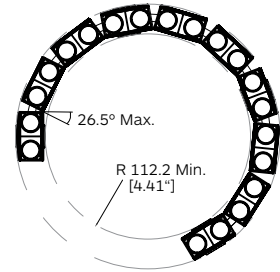
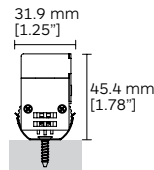

Max. L= 954mm (32 x LED) 16 Links

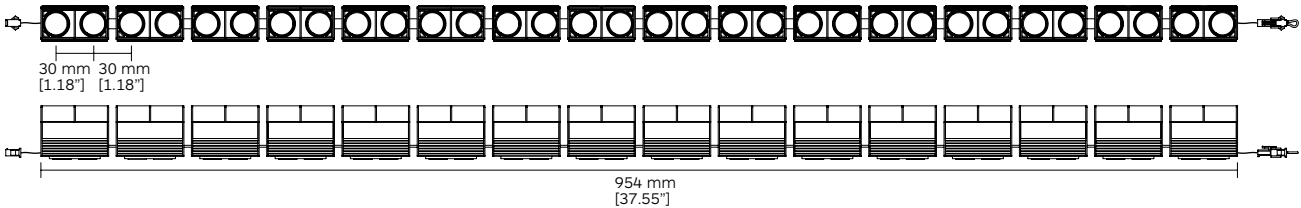

Available length codes

No. of Links	Voltage	LED Power	Length code	Length in mm	Length in inches	Nominal Lumen	No. of Links	Voltage	LED Power	Length code	Length in mm	Length in inches	Nominal Lumen
1	3.3V	3.1W	0054	54	2.12	366 lm	9	29.7V	28.3W	0534	534	21.02	3294 lm
2	6.6V	6.3W	0114	114	4.48	732 lm	10	33V	31.5W	0594	594	23.38	3660 lm
3	9.9V	9.4W	0174	174	6.85	1098 lm	11	36.3V	34.6W	0654	654	25.74	4026 lm
4	13.2V	12.6W	0234	234	9.21	1464 lm	12	39.6V	37.8W	0714	714	28.11	4392 lm
5	16.5V	15.7W	0294	294	11.57	1830 lm	13	42.9V	40.9W	0774	774	30.47	4758 lm
6	19.8V	18.9W	0354	354	13.93	2196 lm	14	46.2V	44.1W	0834	834	32.83	5124 lm
7	23.1V	22W	0414	414	16.29	2562 lm	15	49.5V	47.2W	0894	894	35.19	5490 lm
8	26.4V	25.2W	0474	474	18.66	2928 lm	16	52.8V	50.4W	0954	954	37.55	5856 lm

Code ordering example: **G 4 3 7 0 0 5 4 . 9 0 2 7 1 7 0 0 1 0**

	Product code*	Length code	Light Source	>CRI	CCT**	LED Power	Nominal Lumen	Beam angle (BA°)	Driver Options	Finish	
Cobra Flex Louvre	G437	0054	2 x LED	90	27	2700K	1.5W/LED	183lm/LED	10 / 17 / 29 / EL / WW	00 No Driver	10 ■ Black
Min & Max. Length		0954	32 x LED	30	3000K						
				35	3500K						
				40	4000K						

Recommended Driver: Driver to be ordered separately. Work with 1050mA Constant Current LED Driver positioned remotely. Suggested Driver: 2C02D0, 2C02D1, 2C02DA. Please see page 87 for further information.

Notes:

- * For complete code ordering information, please see page 91.
- ** For other CCT options, Tuneable White / RGB / RGBW version, please contact us.
- EL** = Elliptical Beam (15° x 50°). **WW** = Wallwasher optics.
- For related accessories, please see page 87.
- For the most updated product information, please go to our website.

Cobra Pro IP66

Fixed



Body

Surface mounted modular system in die cast aluminium. Available in different length configurations based on a 83mm link (2 LED per link) with a 76mm increment. Section 34x36.6mm. Its flexible structure maintain a constant 38mm pitch between the LED.

Mounting options:
Fixed brackets.

*** Plastic free packaging.**

Accessories

Mounting accessories included.
Alluminium louvre Art. 2C97
Extension cable Art. 2D47 to be ordered separately.

Finish

Powder coat in black colour.

LED sources

Power LED. CRI: 90 | R9: >50 | CCT: 2700K, 3000K, 3500K, 4000K.
3-Step MacAdam.
Other CRI and CCT options available on request.

Optic

Lens.
Beam angle: 17° / 29° / elliptical (15° x 50°).

Driver

Driver not included to be ordered separately.
Work with 1050 mA Constant Current Driver positioned remotely.
See page 87 for further information.

Applications

Ideal for external indirect cove illumination, it creates a wall grazing effect for columns and curved architectonic surfaces. Its flexible structure maintain a constant pitch between LED, insuring a continuous illumination without any shadows or dark areas. Application areas: Cove light, wallwash, residential, hospitality, restaurants, museums.

Related Products

Cobra Linealuce 
P. 50

Cobra Flex 
P. 52

Cobra Linealuce Louvre 
P. 54

Cobra Flex Louvre 
P. 56

Cobra Pro IP66 Adjustable 
P. 60



Cobra Pro IP66 Fixed



Cobra Pro IP66
Fixed

Min. L= 83mm (2 x LED) 1 Link

Mounting options

With fixed brackets

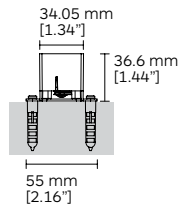
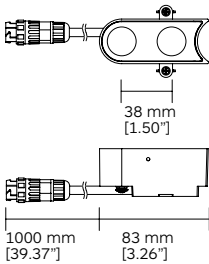

With Louvre Art. 2C97

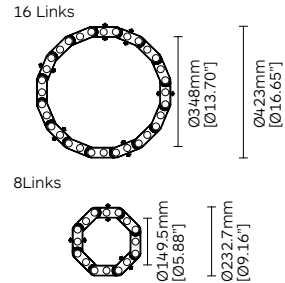
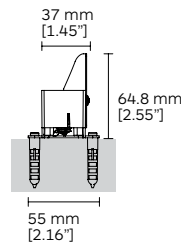

Max. L= 1223mm (32 x LED) 16 Links

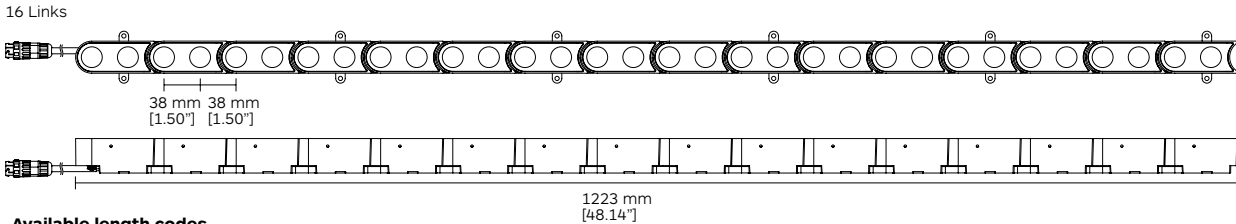

Available length codes

No. of Links	LED Power	Length code	Length in mm	Length in inches	Nominal Lumen	No. of Links	LED Power	Length code	Length in mm	Length in inches	Nominal Lumen
1	3.1W	0083	83	3.26	366 lm	9	28.3W	0691	691	27.20	3294 lm
2	6.3W	0159	159	6.25	732 lm	10	31.5W	0767	767	30.19	3660 lm
3	9.4W	0235	235	9.25	1098 lm	11	34.6W	0843	843	33.18	4026 lm
4	12.6W	0311	311	12.24	1464 lm	12	37.8W	0919	919	36.18	4392 lm
5	15.7W	0387	387	15.23	1830 lm	13	40.9W	0995	995	39.17	4758 lm
6	18.9W	0463	463	18.22	2196 lm	14	44.1W	1071	1071	42.16	5124 lm
7	22W	0539	539	21.22	2562 lm	15	47.2W	1147	1147	45.15	5490 lm
8	25.2W	0615	615	24.21	2928 lm	16	50.4W	1223	1223	48.14	5856 lm

Code ordering example: **G 3 0 1 0 0 8 3 . 9 0 2 7 1 7 D 0 1 0**

	Product code*	Length code	Light Source	>CRI	CCT**	LED Power	Nominal Lumen	Beam angle (BA°)	Driver Options	Finish
Cobra Pro IP66 Fixed	G301	0083	2 x LED	90	27 2700K	1.5W/LED	183lm/LED	17 / 29 / EL	D0 No Dimming	10 ■ Black
		1223	32 x LED	30	3000K				D1 0-10V Dim	
Min & Max. Length				35	3500K				DA Dali Dim	
				40	4000K					

Recommended Driver: Driver included

Notes:

* For complete code ordering information, please see page 91.

** For other CCT options, please contact us.

EL = Elliptical Beam (15° x 50°).

For related accessories, please see page 87.

For the most updated product information, please go to our website.

Cobra Pro IP66

Adjustable



Body

Surface mounted modular system in die cast aluminium. Available in different length configurations based on a 83mm link (2 LED per link) with a 76mm increment. Section 31.9x32.6mm. Its flexible structure maintain a constant 38mm pitch between the LED.

Mounting options:
Adjustable brackets (45° in two directions).

*** Plastic free packaging.**

Accessories

Mounting accessories included.
Alluminium louvre Art. 2C97
Extension cable Art. 2D47 to be ordered separately.

Finish

Powder coat in black colour.

LED sources

Power LED. CRI: 90 | R9: >50 | CCT: 2700K, 3000K, 3500K, 4000K.
3-Step MacAdam.
Other CRI and CCT options available on request.

Optic

Lens.
Beam angle: 17° / 29° / elliptical (15° x 50°).

Driver

Driver not included to be ordered separately.
Work with 1050 mA Constant Current Driver positioned remotely.
See page 87 for further information.

Applications

Ideal for external indirect cove illumination, it creates a wall grazing effect for columns and curved architectonic surfaces. Its flexible structure maintain a constant pitch between LED, insuring a continuous illumination without any shadows or dark areas. Application areas: Cove light, wallwash, residential, hospitality, restaurants, museums.

Related Products

Cobra Linealuce 
P. 50

Cobra Flex 
P. 52

Cobra Linealuce Louvre 
P. 54

Cobra Flex Louvre 
P. 56

Cobra Pro IP66 Fixed 
P. 58



Cobra Pro IP66 Adjustable



Cobra Pro IP66
Adjustable

Min. L= 83mm (2 x LED) 1 Link

Mounting options

With adjustable brackets

16 Links

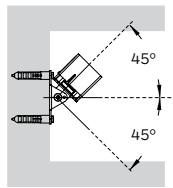
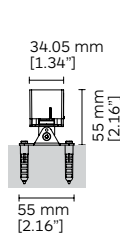
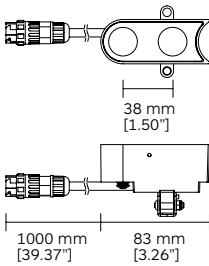

With Louvre Art. 2C97

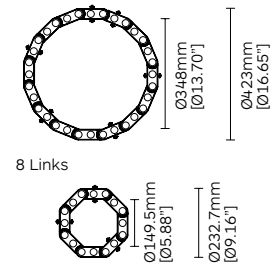
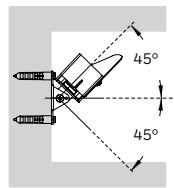
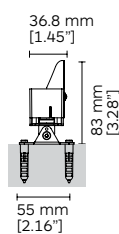

Max. L= 1223mm (32 x LED) 16 Links

16 Links

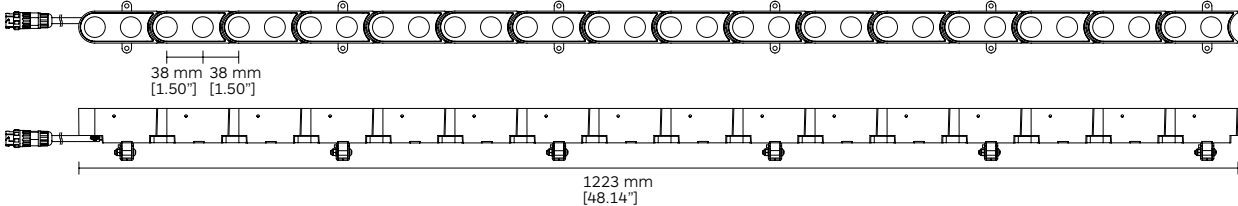

Available length codes

No. of Links	LED Power	Length code	Length in mm	Length in inches	Nominal Lumen	No. of Links	LED Power	Length code	Length in mm	Length in inches	Nominal Lumen
1	3.1W	0083	83	3.26	366 lm	9	28.3W	0691	691	27.20	3294 lm
2	6.3W	0159	159	6.25	732 lm	10	31.5W	0767	767	30.19	3660 lm
3	9.4W	0235	235	9.25	1098 lm	11	34.6W	0843	843	33.18	4026 lm
4	12.6W	0311	311	12.24	1464 lm	12	37.8W	0919	919	36.18	4392 lm
5	15.7W	0387	387	15.23	1830 lm	13	40.9W	0995	995	39.17	4758 lm
6	18.9W	0463	463	18.22	2196 lm	14	44.1W	1071	1071	42.16	5124 lm
7	22W	0539	539	21.22	2562 lm	15	47.2W	1147	1147	45.15	5490 lm
8	25.2W	0615	615	24.21	2928 lm	16	50.4W	1223	1223	48.14	5856 lm

Code ordering example: **G 3 0 2 0 0 8 3 . 9 0 2 7 1 7 D 0 1 0**

	Product code*	Length code	Light Source	>CRI	CCT**	LED Power	Nominal Lumen	Beam angle (BA°)	Driver Options	Finish
Cobra Pro IP66 Adjustable	G302	0083	2 x LED	90	27 2700K	1.5W/LED	183lm/LED	17 / 29 / EL	D0 No Dimming	10 ■ Black
		1223	32 x LED	30	3000K				D1 0-10V Dim	
Min & Max. Length				35	3500K				DA Dali Dim	
				40	4000K					

Recommended Driver: Driver included

Notes:

* For complete code ordering information, please see page 91.

** For other CCT options, please contact us.

EL = Elliptical Beam (15° x 50°).

For related accessories, please see page 87.

For the most updated product information, please go to our website.

Complete Length Codes List

Microline 5 x 5 | 16W/m | G466

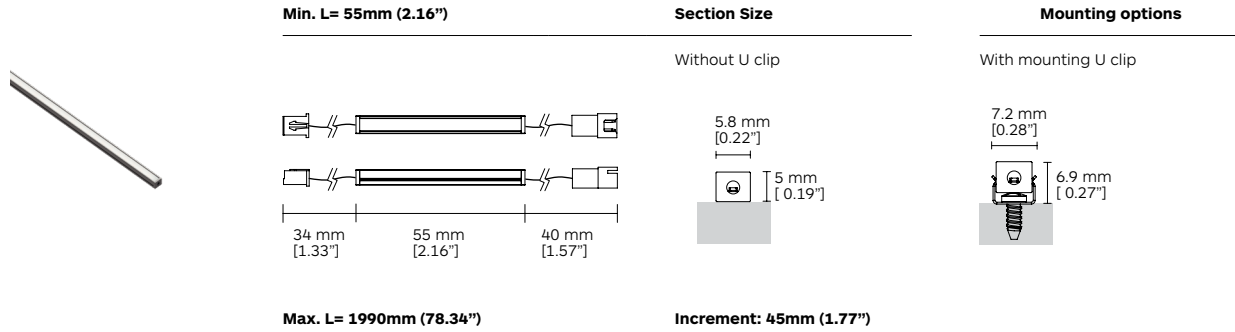

Available length codes

LED Power	Length code	Length in mm	Length in inches	Nominal Lumen	LED Power	Length code	Length in mm	Length in inches	Nominal Lumen	LED Power	Length code	Length in mm	Length in inches	Nominal Lumen
0.72W	0055	55	2.16	78 lm	11.52W	0730	730	28.74	1037 lm	22.32W	1405	1405	55.31	1995 lm
1.44W	0100	100	3.93	142 lm	12.24W	0775	775	30.51	1100 lm	23.04W	1450	1450	57.08	2059 lm
2.16W	0145	145	5.70	206 lm	12.96W	0820	820	32.28	1164 lm	23.76W	1495	1495	58.85	2123 lm
2.88W	0190	190	7.48	270 lm	13.68W	0865	865	34.05	1228 lm	24.48W	1540	1540	60.62	2187 lm
3.60W	0235	235	9.25	334 lm	14.40W	0910	910	35.82	1292 lm	25.20W	1585	1585	62.40	2251 lm
4.32W	0280	280	11.02	398 lm	15.12W	0955	955	37.59	1356 lm	25.92W	1630	1630	64.17	2315 lm
5.04W	0325	325	12.79	461 lm	15.84W	1000	1000	39.37	1420 lm	26.64W	1675	1675	65.94	2378 lm
5.76W	0370	370	14.56	525 lm	16.56W	1045	1045	41.14	1484 lm	27.36W	1720	1720	67.71	2442 lm
6.48W	0415	415	16.33	589 lm	17.28W	1090	1090	42.91	1548 lm	28.08W	1765	1765	69.48	2506 lm
7.20W	0460	460	18.11	653 lm	18.00W	1135	1135	44.68	1612 lm	28.80W	1810	1810	71.25	2570 lm
7.92W	0505	505	19.88	717 lm	18.72W	1180	1180	46.45	1676 lm	29.52W	1855	1855	73.03	2634 lm
8.64W	0550	550	21.65	781 lm	19.44W	1225	1225	48.22	1739 lm	30.24W	1900	1900	74.80	2698 lm
9.36W	0595	595	23.42	845 lm	20.16W	1270	1270	50.00	1803 lm	30.96W	1945	1945	76.57	2762 lm
10.08W	0640	640	25.19	909 lm	20.88W	1315	1315	51.77	1867 lm	31.68W	1990	1990	78.34	2826 lm
10.80W	0685	685	26.96	973 lm	21.60W	1360	1360	53.54	1931 lm					

Notes:

* For driver information, please see page 82.

Complete Length Codes List

Microline 7 x 7 | 19W/m | G447

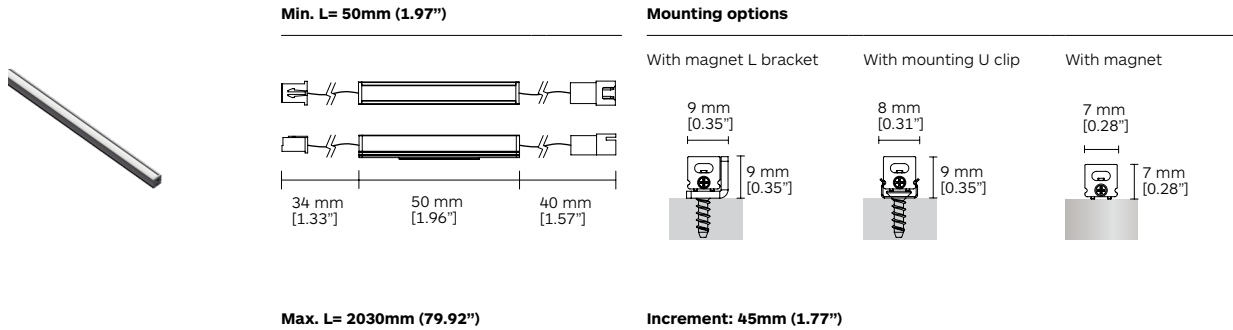

Available length codes

LED Power	Length code	Length in mm	Length in inches	Nominal Lumen	LED Power	Length code	Length in mm	Length in inches	Nominal Lumen	LED Power	Length code	Length in mm	Length in inches	Nominal Lumen
0.86W	0050	50	1.97	85 lm	13.68W	0725	725	28.54	1228 lm	26.51W	1400	1400	55.12	2372 lm
1.71W	0095	95	3.74	161 lm	14.54W	0770	770	30.31	1304 lm	27.36W	1445	1445	56.89	2448 lm
2.57W	0140	140	5.51	237 lm	15.39W	0815	815	32.09	1381 lm	28.22W	1490	1490	58.66	2524 lm
3.42W	0185	185	7.28	313 lm	16.25W	0860	860	33.86	1457 lm	29.07W	1535	1535	60.43	2600 lm
4.28W	0230	230	9.06	390 lm	17.10W	0905	905	35.63	1533 lm	29.93W	1580	1580	62.20	2676 lm
5.13W	0275	275	10.83	466 lm	17.96W	0950	950	37.40	1609 lm	30.78W	1625	1625	63.98	2753 lm
5.99W	0320	320	12.60	542 lm	18.81W	0995	995	39.17	1685 lm	31.64W	1670	1670	65.75	2829 lm
6.84W	0365	365	14.37	618 lm	19.67W	1040	1040	40.94	1762 lm	32.49W	1715	1715	67.52	2905 lm
7.70W	0410	410	16.14	694 lm	20.52W	1085	1085	42.72	1838 lm	33.35W	1760	1760	69.29	2981 lm
8.55W	0455	455	17.91	771 lm	21.38W	1130	1130	44.49	1914 lm	34.20W	1805	1805	71.06	3058 lm
9.41W	0500	500	19.69	847 lm	22.23W	1175	1175	46.26	1990 lm	35.06W	1850	1850	72.83	3134 lm
10.26W	0545	545	21.46	923 lm	23.09W	1220	1220	48.03	2067 lm	35.91W	1895	1895	74.61	3210 lm
11.12W	0590	590	23.23	999 lm	23.94W	1265	1265	49.80	2143 lm	36.77W	1940	1940	76.38	3286 lm
11.97W	0635	635	25.00	1076 lm	24.80W	1310	1310	51.57	2219 lm	37.62W	1985	1985	78.15	3362 lm
12.93W	0680	680	26.77	1152 lm	25.65W	1355	1355	53.35	2295 lm	38.48W	2030	2030	79.92	3439 lm

Notes:

* For driver information, please see page 82.

Complete Length Codes List

Microline 7 x 7 Chain | 0.86W/Link | G442

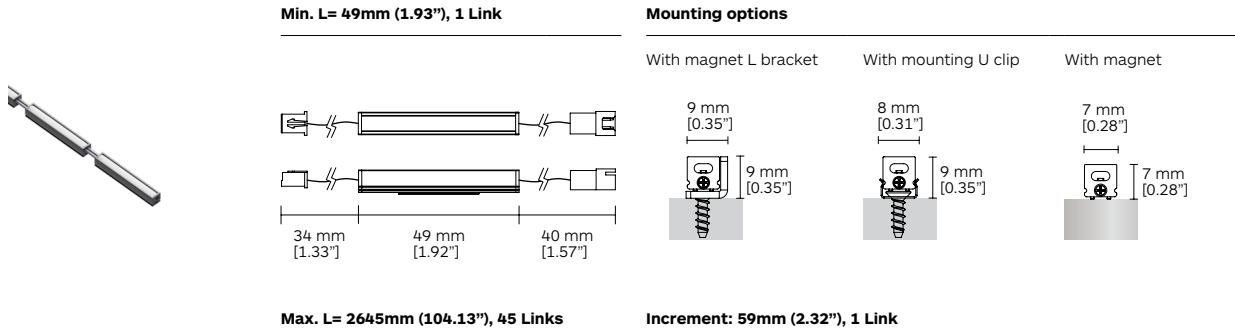

Available length codes

No. of Links	LED Power	Length code	Length in mm	Length in inches	Nominal Lumen	No. of Links	LED Power	Length code	Length in mm	Length in inches	Nominal Lumen
1	0.86W	0049	49	1.93	77 lm	24	20.52W	1406	1406	55.35	1848 lm
2	1.71W	0108	108	4.25	154 lm	25	21.38W	1465	1465	57.68	1925 lm
3	2.57W	0167	167	6.57	231 lm	26	22.23W	1524	1524	60.00	2002 lm
4	3.42W	0226	226	8.90	308 lm	27	23.09W	1583	1583	62.32	2079 lm
5	4.28W	0285	285	11.22	385 lm	28	23.94W	1642	1642	64.65	2156 lm
6	5.13W	0344	344	13.54	462 lm	29	24.80W	1701	1701	66.97	2233 lm
7	5.99W	0403	403	15.87	539 lm	30	25.65W	1760	1760	69.29	2310 lm
8	6.84W	0462	462	18.19	616 lm	31	26.51W	1819	1819	71.61	2387 lm
9	7.70W	0521	521	20.51	693 lm	32	27.36W	1878	1878	73.94	2464 lm
10	8.55W	0580	580	22.83	770 lm	33	28.22W	1937	1937	76.26	2541 lm
11	9.41W	0639	639	25.16	847 lm	34	29.07W	1996	1996	78.58	2618 lm
12	10.26W	0698	698	27.48	924 lm	35	29.93W	2055	2055	80.91	2695 lm
13	11.12W	0757	757	29.80	1001 lm	36	30.78W	2114	2114	83.23	2772 lm
14	11.97W	0816	816	32.13	1078 lm	37	31.64W	2173	2173	85.55	2849 lm
15	12.83W	0875	875	34.45	1155 lm	38	32.49W	2232	2232	87.87	2926 lm
16	13.68W	0934	934	36.77	1232 lm	39	33.35W	2291	2291	90.20	3003 lm
17	14.54W	0993	993	39.09	1309 lm	40	34.20W	2350	2350	92.52	3080 lm
18	15.39W	1052	1052	41.42	1386 lm	41	35.06W	2409	2409	94.84	3157 lm
19	16.25W	1111	1111	43.74	1463 lm	42	35.91W	2468	2468	97.17	3234 lm
20	17.10W	1170	1170	46.06	1540 lm	43	36.77W	2527	2527	99.49	3311 lm
21	17.96W	1229	1229	48.39	1617 lm	44	37.62W	2586	2586	101.81	3388 lm
22	18.81W	1288	1288	50.71	1694 lm	45	38.48W	2645	2645	104.13	3465 lm
23	19.67W	1347	1347	53.03	1771 lm						

Notes:

* For driver information, please see page 82.

Complete Length Codes List

Microline 7 x 7 Corner | 19W/m | G446

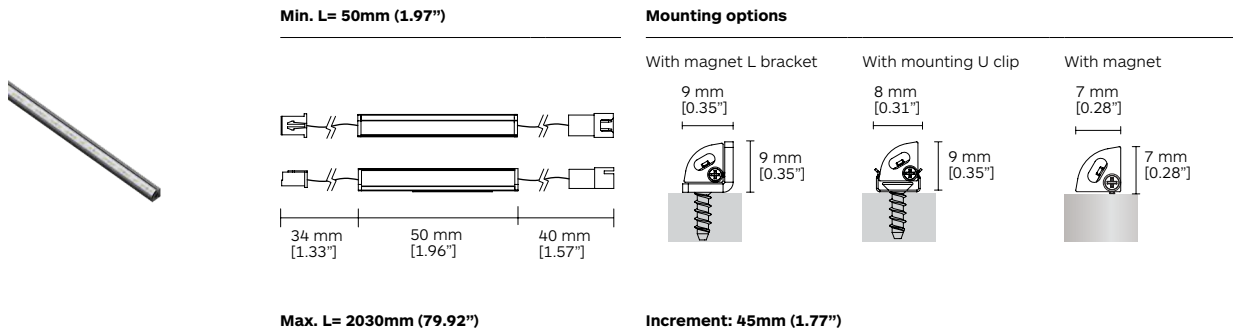

Available length codes

LED Power	Length code	Length in mm	Length in inches	Nominal Lumen	LED Power	Length code	Length in mm	Length in inches	Nominal Lumen	LED Power	Length code	Length in mm	Length in inches	Nominal Lumen
0.86W	0050	50	1.97	85 lm	13.68W	0725	725	28.54	1228 lm	26.51W	1400	1400	55.12	2372 lm
1.71W	0095	95	3.74	161 lm	14.54W	0770	770	30.31	1304 lm	27.36W	1445	1445	56.89	2448 lm
2.57W	0140	140	5.51	237 lm	15.39W	0815	815	32.09	1381 lm	28.22W	1490	1490	58.66	2524 lm
3.42W	0185	185	7.28	313 lm	16.25W	0860	860	33.86	1457 lm	29.07W	1535	1535	60.43	2600 lm
4.28W	0230	230	9.06	390 lm	17.10W	0905	905	35.63	1533 lm	29.93W	1580	1580	62.20	2676 lm
5.13W	0275	275	10.83	466 lm	17.96W	0950	950	37.40	1609 lm	30.78W	1625	1625	63.98	2753 lm
5.99W	0320	320	12.60	542 lm	18.81W	0995	995	39.17	1685 lm	31.64W	1670	1670	65.75	2829 lm
6.84W	0365	365	14.37	618 lm	19.67W	1040	1040	40.94	1762 lm	32.49W	1715	1715	67.52	2905 lm
7.70W	0410	410	16.14	694 lm	20.52W	1085	1085	42.72	1838 lm	33.35W	1760	1760	69.29	2981 lm
8.55W	0455	455	17.91	771 lm	21.38W	1130	1130	44.49	1914 lm	34.20W	1805	1805	71.06	3058 lm
9.41W	0500	500	19.69	847 lm	22.23W	1175	1175	46.26	1990 lm	35.06W	1850	1850	72.83	3134 lm
10.26W	0545	545	21.46	923 lm	23.09W	1220	1220	48.03	2067 lm	35.91W	1895	1895	74.61	3210 lm
11.12W	0590	590	23.23	999 lm	23.94W	1265	1265	49.80	2143 lm	36.77W	1940	1940	76.38	3286 lm
11.97W	0635	635	25.00	1076 lm	24.80W	1310	1310	51.57	2219 lm	37.62W	1985	1985	78.15	3363 lm
12.93W	0680	680	26.77	1152 lm	25.65W	1355	1355	53.35	2295 lm	38.48W	2030	2030	79.92	3439 lm

Notes:

* For driver information, please see page 82.

Complete Length Codes List

Microline 7 x 7 Corner Chain | 0.86W/Link | G431

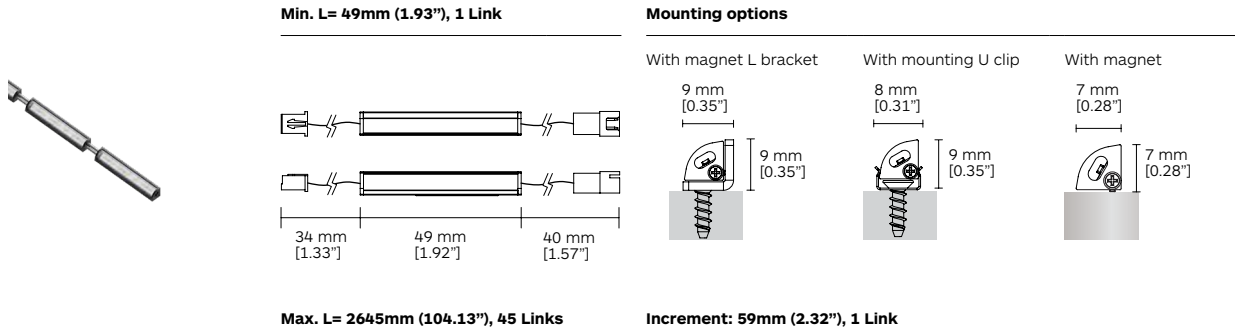

Available length codes

No. of Links	LED Power	Length code	Length in mm	Length in inches	Nominal Lumen	No. of Links	LED Power	Length code	Length in mm	Length in inches	Nominal Lumen
1	0.86W	0049	49	1.93	77 lm	24	20.52W	1406	1406	55.35	1848 lm
2	1.71W	0108	108	4.25	154 lm	25	21.38W	1465	1465	57.68	1925 lm
3	2.57W	0167	167	6.57	231 lm	26	22.23W	1524	1524	60.00	2002 lm
4	3.42W	0226	226	8.90	308 lm	27	23.09W	1583	1583	62.32	2079 lm
5	4.28W	0285	285	11.22	385 lm	28	23.94W	1642	1642	64.65	2156 lm
6	5.13W	0344	344	13.54	462 lm	29	24.80W	1701	1701	66.97	2233 lm
7	5.99W	0403	403	15.87	539 lm	30	25.65W	1760	1760	69.29	2310 lm
8	6.84W	0462	462	18.19	616 lm	31	26.51W	1819	1819	71.61	2387 lm
9	7.70W	0521	521	20.51	693 lm	32	27.36W	1878	1878	73.94	2464 lm
10	8.55W	0580	580	22.83	770 lm	33	28.22W	1937	1937	76.26	2541 lm
11	9.41W	0639	639	25.16	847 lm	34	29.07W	1996	1996	78.58	2618 lm
12	10.26W	0698	698	27.48	924 lm	35	29.93W	2055	2055	80.91	2695 lm
13	11.12W	0757	757	29.80	1001 lm	36	30.78W	2114	2114	83.23	2772 lm
14	11.97W	0816	816	32.13	1078 lm	37	31.64W	2173	2173	85.55	2849 lm
15	12.83W	0875	875	34.45	1155 lm	38	32.49W	2232	2232	87.87	2926 lm
16	13.68W	0934	934	36.77	1232 lm	39	33.35W	2291	2291	90.20	3003 lm
17	14.54W	0993	993	39.09	1309 lm	40	34.20W	2350	2350	92.52	3080 lm
18	15.39W	1052	1052	41.42	1386 lm	41	35.06W	2409	2409	94.84	3157 lm
19	16.25W	1111	1111	43.74	1463 lm	42	35.91W	2468	2468	97.17	3234 lm
20	17.10W	1170	1170	46.06	1540 lm	43	36.77W	2527	2527	99.49	3311 lm
21	17.96W	1229	1229	48.39	1617 lm	44	37.62W	2586	2586	101.81	3388 lm
22	18.81W	1288	1288	50.71	1694 lm	45	38.48W	2645	2645	104.13	3465 lm
23	19.67W	1347	1347	53.03	1771 lm						

Notes:

* For driver information, please see page 82.

Complete Length Codes List

Microline 10 x 6 | 16W/m | G460

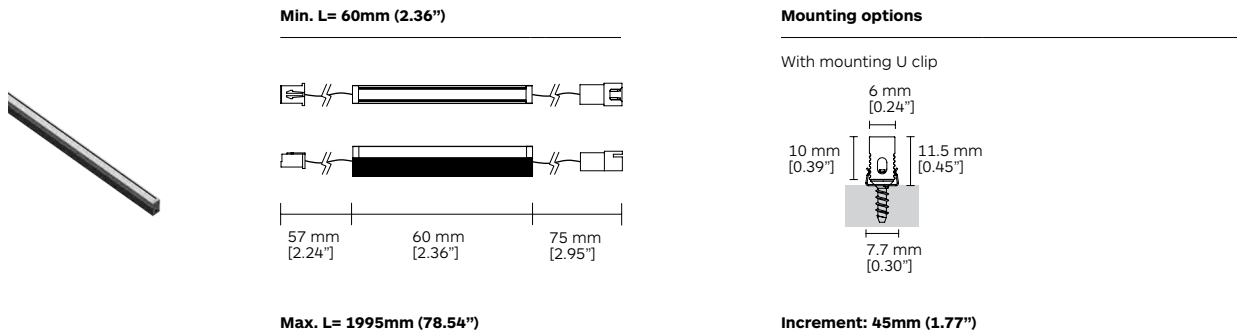

Available length codes

LED Power	Length code	Length in mm	Length in inches	Nominal Lumen	LED Power	Length code	Length in mm	Length in inches	Nominal Lumen	LED Power	Length code	Length in mm	Length in inches	Nominal Lumen
0.72W	0060	60	2.36	85 lm	11.52W	0735	735	28.93	1044 lm	22.32W	1410	1410	55.51	2002 lm
1.44W	0105	105	4.13	149 lm	12.24W	0780	780	30.70	1108 lm	23.04W	1455	1455	57.28	2066 lm
2.16W	0150	150	5.90	213 lm	12.96W	0825	825	32.48	1171 lm	23.76W	1500	1500	59.05	2130 lm
2.88W	0195	195	7.67	277 lm	13.68W	0870	870	34.25	1235 lm	24.48W	1545	1545	60.82	2194 lm
3.60W	0240	240	9.44	341 lm	14.40W	0915	915	36.02	1299 lm	25.20W	1590	1590	62.59	2258 lm
4.32W	0285	285	11.22	405 lm	15.12W	0960	960	37.79	1363 lm	25.92W	1635	1635	64.37	2322 lm
5.04W	0330	330	12.99	469 lm	15.84W	1005	1005	39.56	1427 lm	26.64W	1680	1680	66.14	2386 lm
5.76W	0375	375	14.76	532 lm	16.56W	1050	1050	41.33	1491 lm	27.36W	1725	1725	67.91	2449 lm
6.48W	0420	420	16.53	596 lm	17.28W	1095	1095	43.11	1555 lm	28.08W	1770	1770	69.68	2513 lm
7.20W	0465	465	18.30	660 lm	18.00W	1140	1140	44.88	1619 lm	28.80W	1815	1815	71.45	2577 lm
7.92W	0510	510	20.07	724 lm	18.72W	1185	1185	46.65	1683 lm	29.52W	1860	1860	73.22	2641 lm
8.64W	0555	555	21.85	788 lm	19.44W	1230	1230	48.42	1747 lm	30.24W	1905	1905	75.00	2705 lm
9.36W	0600	600	23.62	852 lm	20.16W	1275	1275	50.19	1810 lm	30.96W	1950	1950	76.77	2769 lm
10.08W	0645	645	25.39	916 lm	20.88W	1320	1320	51.96	1874 lm	31.68W	1995	1995	78.54	2833 lm
10.80W	0690	690	27.16	980 lm	21.60W	1365	1365	53.74	1938 lm					

Notes:

* For driver information, please see page 83.

Complete Length Codes List

Microline 9 x 8 | 16W/m | G461



Min. L= 60mm (2.36")

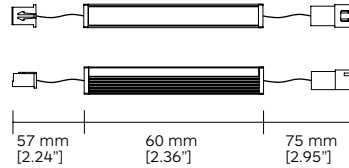

Max. L= 1995mm (78.54")

Mounting options

With mounting U clip

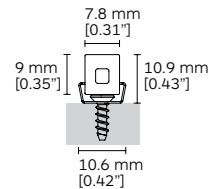

Increment: 45mm (1.77")

Available length codes

LED Power	Length code	Length in mm	Length in inches	Nominal Lumen	LED Power	Length code	Length in mm	Length in inches	Nominal Lumen	LED Power	Length code	Length in mm	Length in inches	Nominal Lumen
0.72W	0060	60	2.36	85 lm	11.52W	0735	735	28.93	1044 lm	22.32W	1410	1410	55.51	2002 lm
1.44W	0105	105	4.13	149 lm	12.24W	0780	780	30.70	1108 lm	23.04W	1455	1455	57.28	2066 lm
2.16W	0150	150	5.90	213 lm	12.96W	0825	825	32.48	1171 lm	23.76W	1500	1500	59.05	2130 lm
2.88W	0195	195	7.67	277 lm	13.68W	0870	870	34.25	1235 lm	24.48W	1545	1545	60.82	2194 lm
3.60W	0240	240	9.44	341 lm	14.40W	0915	915	36.02	1299 lm	25.20W	1590	1590	62.59	2258 lm
4.32W	0285	285	11.22	405 lm	15.12W	0960	960	37.79	1363 lm	25.92W	1635	1635	64.37	2322 lm
5.04W	0330	330	12.99	469 lm	15.84W	1005	1005	39.56	1427 lm	26.64W	1680	1680	66.14	2386 lm
5.76W	0375	375	14.76	532 lm	16.56W	1050	1050	41.33	1491 lm	27.36W	1725	1725	67.91	2449 lm
6.48W	0420	420	16.53	596 lm	17.28W	1095	1095	43.11	1555 lm	28.08W	1770	1770	69.68	2513 lm
7.20W	0465	465	18.30	660 lm	18.00W	1140	1140	44.88	1619 lm	28.80W	1815	1815	71.45	2577 lm
7.92W	0510	510	20.07	724 lm	18.72W	1185	1185	46.65	1683 lm	29.52W	1860	1860	73.22	2641 lm
8.64W	0555	555	21.85	788 lm	19.44W	1230	1230	48.42	1747 lm	30.24W	1905	1905	75.00	2705 lm
9.36W	0600	600	23.62	852 lm	20.16W	1275	1275	50.19	1810 lm	30.96W	1950	1950	76.77	2769 lm
10.08W	0645	645	25.39	916 lm	20.88W	1320	1320	51.96	1874 lm	31.68W	1995	1995	78.54	2833 lm
10.80W	0690	690	27.16	980 lm	21.60W	1365	1365	53.74	1938 lm					

Notes:

* For driver information, please see page 83.

Complete Length Codes List

Microline Ø9 | 19W/m | G421

Min. L= 40mm (1.57")

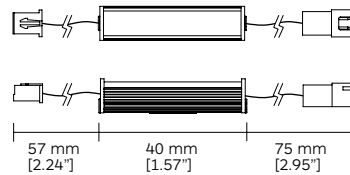

Max. L= 2105mm (82.87")

Mounting options

With magnet L bracket

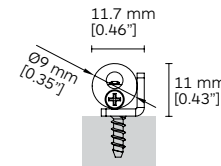

With mounting U clip

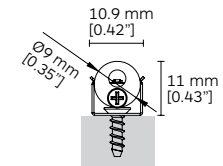

Increment: 35mm (1.37")

Available length codes

LED Power	Length code	Length in mm	Length in inches	Nominal Lumen	LED Power	Length code	Length in mm	Length in inches	Nominal Lumen	LED Power	Length code	Length in mm	Length in inches	Nominal Lumen
0.60W	0040	40	1.57	68 lm	12.50W	0740	740	29.13	1253 lm	24.40W	1440	1440	56.69	2439 lm
1.19W	0075	75	2.95	127 lm	13.09W	0775	775	30.51	1313 lm	24.99W	1475	1475	58.07	2499 lm
1.79W	0110	110	4.33	186 lm	13.69W	0810	810	31.88	1372 lm	25.59W	1510	1510	59.44	2558 lm
2.38W	0145	145	5.70	246 lm	14.28W	0845	845	33.26	1431 lm	26.18W	1545	1545	60.82	2617 lm
2.98W	0180	180	7.08	305 lm	14.88W	0880	880	34.64	1491 lm	26.78W	1580	1580	62.20	2676 lm
3.57W	0215	215	8.46	364 lm	15.47W	0915	915	36.02	1550 lm	27.37W	1615	1615	63.58	2736 lm
4.17W	0250	250	9.84	423 lm	16.07W	0950	950	37.40	1609 lm	27.97W	1650	1650	64.96	2795 lm
4.76W	0285	285	11.22	483 lm	16.66W	0985	985	38.77	1668 lm	28.56W	1685	1685	66.33	2854 lm
5.36W	0320	320	12.59	542 lm	17.26W	1020	1020	40.15	1728 lm	29.16W	1720	1720	67.71	2914 lm
5.95W	0355	355	13.97	601 lm	17.85W	1055	1055	41.53	1787 lm	29.75W	1755	1755	69.09	2973 lm
6.55W	0390	390	15.35	661 lm	18.45W	1090	1090	42.91	1846 lm	30.35W	1790	1790	70.47	3032 lm
7.14W	0425	425	16.73	720 lm	19.04W	1125	1125	44.29	1906 lm	30.94W	1825	1825	71.85	3091 lm
7.74W	0460	460	18.11	779 lm	19.64W	1160	1160	45.66	1965 lm	31.54W	1860	1860	73.22	3151 lm
8.33W	0495	495	19.48	838 lm	20.23W	1195	1195	47.04	2024 lm	32.13W	1895	1895	74.60	3210 lm
8.93W	0530	530	20.86	898 lm	20.83W	1230	1230	48.42	2084 lm	32.73W	1930	1930	75.98	3269 lm
9.52W	0565	565	22.24	957 lm	21.42W	1265	1265	49.80	2143 lm	33.32W	1965	1965	77.36	3329 lm
10.12W	0600	600	23.62	1016 lm	22.02W	1300	1300	51.18	2202 lm	33.92W	2000	2000	78.74	3388 lm
10.71W	0635	635	25.00	1076 lm	22.61W	1335	1335	52.55	2261 lm	34.51W	2035	2035	80.11	3447 lm
11.31W	0670	670	26.37	1135 lm	23.21W	1370	1370	53.93	2321 lm	35.11W	2070	2070	81.49	3506 lm
11.90W	0705	705	27.75	1195 lm	23.80W	1405	1405	55.31	2380 lm	35.70W	2105	2105	82.87	3566 lm

Notes:

* For driver information, please see page 83.

Complete Length Codes List

Microline Ø14 | 16W/m | G445

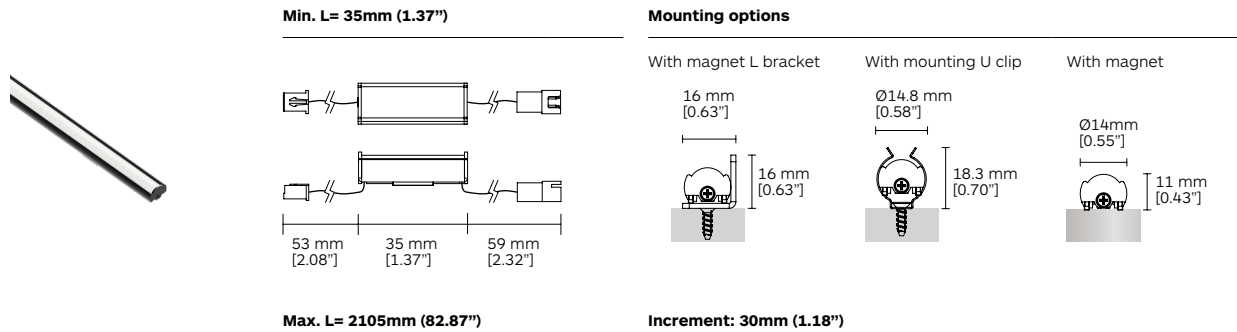

Available length codes

LED Power	Length code	Length in mm	Length in inches	Nominal Lumen	LED Power	Length code	Length in mm	Length in inches	Nominal Lumen	LED Power	Length code	Length in mm	Length in inches	Nominal Lumen
0.48W	0035	35	1.37	45 lm	12.00W	0755	755	29.72	972 lm	23.52W	1475	1475	58.07	1898 lm
0.96W	0065	65	2.56	84 lm	12.48W	0785	785	30.91	1010 lm	24.00W	1505	1505	59.25	1937 lm
1.44W	0095	95	3.74	122 lm	12.96W	0815	815	32.09	1049 lm	24.48W	1535	1535	60.43	1976 lm
1.92W	0125	125	4.92	161 lm	13.44W	0845	845	33.27	1088 lm	24.96W	1565	1565	61.61	2014 lm
2.40W	0155	155	6.10	199 lm	13.92W	0875	875	34.45	1126 lm	25.44W	1595	1595	62.80	2053 lm
2.88W	0185	185	7.28	238 lm	14.40W	0905	905	35.63	1165 lm	25.92W	1625	1625	63.98	2091 lm
3.36W	0215	215	8.46	277 lm	14.88W	0935	935	36.81	1203 lm	26.40W	1655	1655	65.16	2130 lm
3.84W	0245	245	9.65	315 lm	15.36W	0965	965	37.99	1242 lm	26.88W	1685	1685	66.34	2169 lm
4.32W	0275	275	10.83	354 lm	15.84W	0995	995	39.17	1281 lm	27.36W	1715	1715	67.52	2207 lm
4.80W	0305	305	12.01	393 lm	16.32W	1025	1025	40.35	1319 lm	27.84W	1745	1745	68.70	2246 lm
5.28W	0335	335	13.19	431 lm	16.80W	1055	1055	41.54	1358 lm	28.32W	1775	1775	69.88	2284 lm
5.76W	0365	365	14.37	470 lm	17.28W	1085	1085	42.72	1396 lm	28.80W	1805	1805	71.06	2323 lm
6.24W	0395	395	15.55	508 lm	17.76W	1115	1115	43.90	1435 lm	29.28W	1835	1835	72.24	2362 lm
6.72W	0425	425	16.73	547 lm	18.24W	1145	1145	45.08	1474 lm	29.76W	1865	1865	73.43	2400 lm
7.20W	0455	455	17.91	586 lm	18.72W	1175	1175	46.26	1512 lm	30.24W	1895	1895	74.61	2439 lm
7.68W	0485	485	19.09	624 lm	19.20W	1205	1205	47.44	1551 lm	30.72W	1925	1925	75.79	2477 lm
8.16W	0515	515	20.28	663 lm	19.68W	1235	1235	48.62	1589 lm	31.20W	1955	1955	76.97	2516 lm
8.64W	0545	545	21.46	701 lm	20.16W	1265	1265	49.80	1628 lm	31.68W	1985	1985	78.15	2555 lm
9.12W	0575	575	22.64	740 lm	20.64W	1295	1295	50.98	1667 lm	32.16W	2015	2015	79.33	2593 lm
9.60W	0605	605	23.82	779 lm	21.12W	1325	1325	52.17	1705 lm	32.64W	2045	2045	80.51	2632 lm
10.08W	0635	635	25.00	817 lm	21.60W	1355	1355	53.35	1744 lm	33.12W	2075	2075	81.69	2671 lm
10.56W	0665	665	26.18	856 lm	22.08W	1385	1385	54.53	1782 lm	33.60W	2105	2105	82.87	2709 lm
11.04W	0695	695	27.36	894 lm	22.56W	1415	1415	55.71	1821 lm					
11.52W	0725	725	28.54	933 lm	23.04W	1445	1445	56.89	1860 lm					

Notes:

* For driver information, please see page 83.

Complete Length Codes List

Microline Ø14 | 20W/m | G420

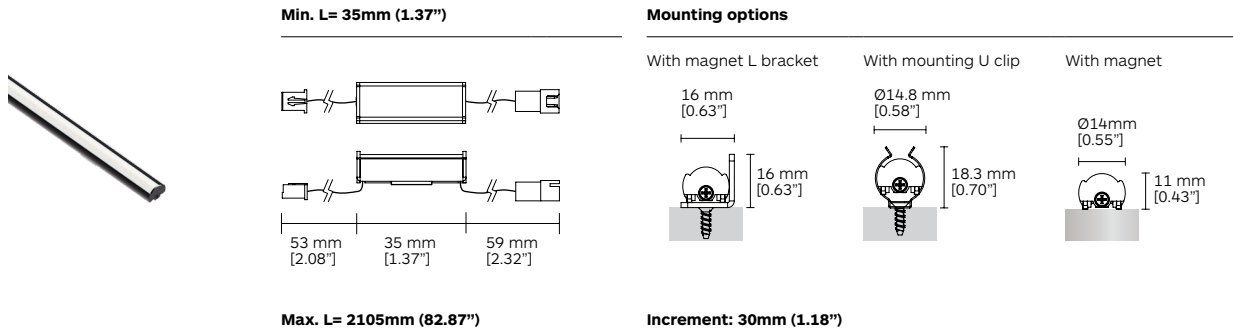

Available length codes

LED Power	Length code	Length in mm	Length in inches	Nominal Lumen	LED Power	Length code	Length in mm	Length in inches	Nominal Lumen	LED Power	Length code	Length in mm	Length in inches	Nominal Lumen
0.60W	0035	35	1.37	63 lm	15.00W	0755	755	29.72	1370 lm	29.40W	1475	1475	58.07	2677 lm
1.20W	0065	65	2.56	118 lm	15.60W	0785	785	30.91	1425 lm	30.00W	1505	1505	59.25	2731 lm
1.80W	0095	95	3.74	172 lm	16.20W	0815	815	32.09	1479 lm	30.60W	1535	1535	60.43	2786 lm
2.40W	0125	125	4.92	227 lm	16.80W	0845	845	33.27	1534 lm	31.20W	1565	1565	61.61	2840 lm
3.00W	0155	155	6.10	281 lm	17.40W	0875	875	34.45	1588 lm	31.80W	1595	1595	62.80	2895 lm
3.60W	0185	185	7.28	336 lm	18.00W	0905	905	35.63	1642 lm	32.40W	1625	1625	63.98	2949 lm
4.20W	0215	215	8.46	390 lm	18.60W	0935	935	36.81	1697 lm	33.00W	1655	1655	65.16	3004 lm
4.80W	0245	245	9.65	445 lm	19.20W	0965	965	37.99	1751 lm	33.60W	1685	1685	66.34	3058 lm
5.40W	0275	275	10.83	499 lm	19.80W	0995	995	39.17	1806 lm	34.20W	1715	1715	67.52	3113 lm
6.00W	0305	305	12.01	553 lm	20.40W	1025	1025	40.35	1860 lm	34.80W	1745	1745	68.70	3167 lm
6.60W	0335	335	13.19	608 lm	21.00W	1055	1055	41.54	1915 lm	35.40W	1775	1775	69.88	3222 lm
7.20W	0365	365	14.37	662 lm	21.60W	1085	1085	42.72	1969 lm	36.00W	1805	1805	71.06	3276 lm
7.80W	0395	395	15.55	717 lm	22.20W	1115	1115	43.90	2024 lm	36.60W	1835	1835	72.24	3330 lm
8.40W	0425	425	16.73	771 lm	22.80W	1145	1145	45.08	2078 lm	37.20W	1865	1865	73.43	3385 lm
9.00W	0455	455	17.91	826 lm	23.40W	1175	1175	46.26	2133 lm	37.80W	1895	1895	74.61	3439 lm
9.60W	0485	485	19.09	880 lm	24.00W	1205	1205	47.44	2187 lm	38.40W	1925	1925	75.79	3494 lm
10.20W	0515	515	20.28	935 lm	24.60W	1235	1235	48.62	2241 lm	39.00W	1955	1955	76.97	3548 lm
10.80W	0545	545	21.46	989 lm	25.20W	1265	1265	49.80	2296 lm	39.60W	1985	1985	78.15	3603 lm
11.40W	0575	575	22.64	1044 lm	25.80W	1295	1295	50.98	2350 lm	40.20W	2015	2015	79.33	3657 lm
12.00W	0605	605	23.82	1098 lm	26.40W	1325	1325	52.17	2405 lm	40.80W	2045	2045	80.51	3712 lm
12.60W	0635	635	25.00	1152 lm	27.00W	1355	1355	53.35	2459 lm	41.40W	2075	2075	81.69	3766 lm
13.20W	0665	665	26.18	1207 lm	27.60W	1385	1385	54.53	2514 lm	42.00W	2105	2105	82.87	3820 lm
13.80W	0695	695	27.36	1261 lm	28.20W	1415	1415	55.71	2568 lm					
14.40W	0725	725	28.54	1316 lm	28.80W	1445	1445	56.89	2623 lm					

Notes:

* For driver information, please see page 83.

Complete Length Codes List

Microline Ø14 | 31W/m | G422

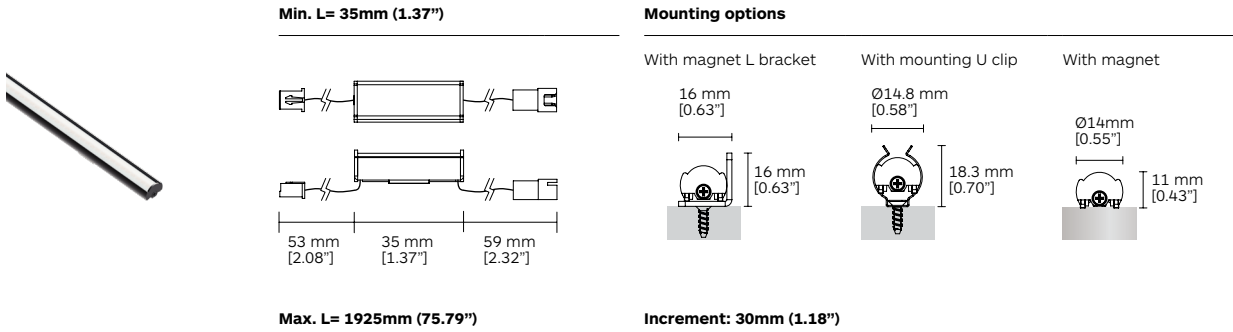

Available length codes

LED Power	Length code	Length in mm	Length in inches	Nominal Lumen	LED Power	Length code	Length in mm	Length in inches	Nominal Lumen	LED Power	Length code	Length in mm	Length in inches	Nominal Lumen
0.93W	0035	35	1.37	110 lm	23.25W	0755	755	29.72	2380 lm	45.57W	1475	1475	58.07	4649 lm
1.86W	0065	65	2.56	205 lm	24.18W	0785	785	30.91	2474 lm	46.50W	1505	1505	59.25	4744 lm
2.79W	0095	95	3.74	299 lm	25.11W	0815	815	32.09	2569 lm	47.43W	1535	1535	60.43	4838 lm
3.72W	0125	125	4.92	394 lm	26.04W	0845	845	33.27	2663 lm	48.36W	1565	1565	61.61	4933 lm
4.65W	0155	155	6.10	488 lm	26.97W	0875	875	34.45	2758 lm	49.29W	1595	1595	62.80	5027 lm
5.58W	0185	185	7.28	583 lm	27.90W	0905	905	35.63	2852 lm	50.22W	1625	1625	63.98	5122 lm
6.51W	0215	215	8.46	678 lm	28.83W	0935	935	36.81	2947 lm	51.15W	1655	1655	65.16	5216 lm
7.44W	0245	245	9.65	772 lm	29.76W	0965	965	37.99	3042 lm	52.08W	1685	1685	66.34	5311 lm
8.37W	0275	275	10.83	867 lm	30.69W	0995	995	39.17	3136 lm	53.01W	1715	1715	67.52	5406 lm
9.30W	0305	305	12.01	961 lm	31.62W	1025	1025	40.35	3231 lm	53.94W	1745	1745	68.70	5500 lm
10.23W	0335	335	13.19	1056 lm	32.55W	1055	1055	41.54	3325 lm	54.87W	1775	1775	69.88	5595 lm
11.16W	0365	365	14.37	1150 lm	33.48W	1085	1085	42.72	3420 lm	55.80W	1805	1805	71.06	5689 lm
12.09W	0395	395	15.55	1245 lm	34.41W	1115	1115	43.90	3514 lm	56.73W	1835	1835	72.24	5784 lm
13.02W	0425	425	16.73	1340 lm	35.34W	1145	1145	45.08	3609 lm	57.66W	1865	1865	73.43	5878 lm
13.95W	0455	455	17.91	1434 lm	36.27W	1175	1175	46.26	3704 lm	58.59W	1895	1895	74.61	5973 lm
14.88W	0485	485	19.09	1529 lm	37.20W	1205	1205	47.44	3798 lm	59.52W	1925	1925	75.79	6067 lm
15.81W	0515	515	20.28	1623 lm	38.13W	1235	1235	48.62	3893 lm					
16.74W	0545	545	21.46	1718 lm	39.06W	1265	1265	49.80	3987 lm					
17.67W	0575	575	22.64	1812 lm	39.99W	1295	1295	50.98	4082 lm					
18.60W	0605	605	23.82	1907 lm	40.92W	1325	1325	52.17	4176 lm					
19.53W	0635	635	25.00	2001 lm	41.85W	1355	1355	53.35	4271 lm					
20.46W	0665	665	26.18	2096 lm	42.78W	1385	1385	54.53	4365 lm					
21.39W	0695	695	27.36	2191 lm	43.71W	1415	1415	55.71	4460 lm					
22.32W	0725	725	28.54	2285 lm	44.64W	1445	1445	56.89	4555 lm					

Notes:

* For driver information, please see page 83.

Complete Length Codes List

Microline Ø14 Chain | 1.2W/Link | G435

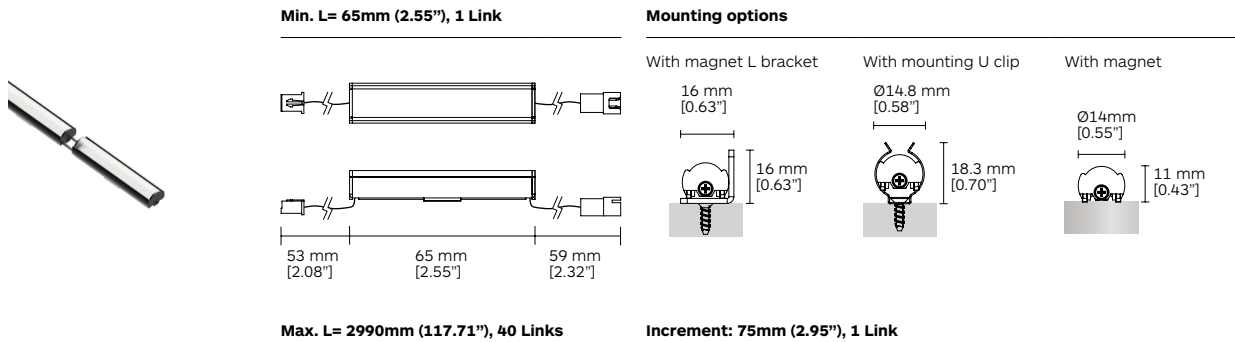

Available length codes

No. of Links	LED Power	Length code	Length in mm	Length in inches	Nominal Lumen	No. of Links	LED Power	Length code	Length in mm	Length in inches	Nominal Lumen
1	1.20W	0065	65	2.56	118 lm	21	25.20W	1565	1565	61.61	2478 lm
2	2.40W	0140	140	5.51	236 lm	22	26.40W	1640	1640	64.57	2596 lm
3	3.60W	0215	215	8.46	354 lm	23	27.60W	1715	1715	67.52	2714 lm
4	4.80W	0290	290	11.42	472 lm	24	28.80W	1790	1790	70.47	2832 lm
5	6.00W	0365	365	14.37	590 lm	25	30.00W	1865	1865	73.43	2950 lm
6	7.20W	0440	440	17.32	708 lm	26	31.20W	1940	1940	76.38	3068 lm
7	8.40W	0515	515	20.28	826 lm	27	32.40W	2015	2015	79.33	3186 lm
8	9.60W	0590	590	23.23	944 lm	28	33.60W	2090	2090	82.28	3504 lm
9	10.80W	0665	665	26.18	1062 lm	29	34.80W	2165	2165	85.24	3422 lm
10	12.00W	0740	740	29.13	1180 lm	30	36.00W	2240	2240	88.19	3540 lm
11	13.20W	0815	815	32.09	1298 lm	31	37.20W	2315	2315	91.14	3658 lm
12	14.40W	0890	890	35.04	1416 lm	32	38.40W	2390	2390	94.09	3776 lm
13	15.60W	0965	965	37.99	1534 lm	33	39.60W	2465	2465	97.05	3894 lm
14	16.80W	1040	1040	40.94	1652 lm	34	40.80W	2540	2540	100.00	4012 lm
15	18.00W	1115	1115	43.90	1770 lm	35	42.00W	2615	2615	102.95	4130 lm
16	19.20W	1190	1190	46.85	1888 lm	36	43.20W	2690	2690	105.91	4248 lm
17	20.40W	1265	1265	49.80	2006 lm	37	44.40W	2765	2765	108.86	4366 lm
18	21.60W	1340	1340	52.76	2124 lm	38	45.60W	2840	2840	111.81	4484 lm
19	22.80W	1415	1415	55.71	2242 lm	39	46.80W	2915	2915	114.76	4602 lm
20	24.00W	1490	1490	58.66	2360 lm	40	48.00W	2990	2990	117.72	4720 lm

Notes:

* For driver information, please see page 83.

Complete Length Codes List

Microline Ø14 Chain | 1.9W/Link | G436

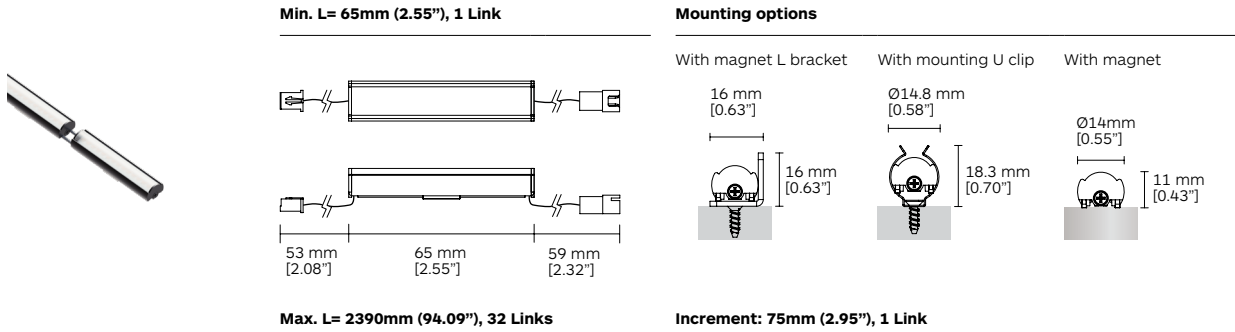

Available length codes

No. of Links	LED Power	Length code	Length in mm	Length in inches	Nominal Lumen
1	1.86W	0065	65	2.56	164 lm
2	3.72W	0140	140	5.51	328 lm
3	5.58W	0215	215	8.46	492 lm
4	7.44W	0290	290	11.42	656 lm
5	9.30W	0365	365	14.37	820 lm
6	11.16W	0440	440	17.32	984 lm
7	13.02W	0515	515	20.28	1148 lm
8	14.88W	0590	590	23.23	1312 lm
9	16.74W	0665	665	26.18	1476 lm
10	18.60W	0740	740	29.13	1640 lm
11	20.46W	0815	815	32.09	1804 lm
12	22.32W	0890	890	35.04	1968 lm
13	24.18W	0965	965	37.99	2132 lm
14	26.04W	1040	1040	40.94	2296 lm
15	27.90W	1115	1115	43.90	2460 lm
16	29.76W	1190	1190	46.85	2624 lm
17	31.62W	1265	1265	49.80	2788 lm
18	33.48W	1340	1340	52.76	2952 lm
19	33.34W	1415	1415	55.71	3116 lm
20	37.20W	1490	1490	58.66	3280 lm
21	39.06W	1565	1565	61.61	3444 lm
22	40.92W	1640	1640	64.57	3608 lm
23	42.78W	1715	1715	67.52	3772 lm
24	44.64W	1790	1790	70.47	3936 lm
25	46.50W	1865	1865	73.43	4100 lm
26	48.36W	1940	1940	76.38	4264 lm
27	50.22W	2015	2015	79.33	4428 lm
28	52.08W	2090	2090	82.28	4592 lm
29	53.94W	2165	2165	85.24	4756 lm
30	55.80W	2240	2240	88.19	4920 lm
31	57.66W	2315	2315	91.14	5084 lm
32	59.52W	2390	2390	94.09	5248 lm

Notes:

* For driver information, please see page 83.

Complete Length Codes List

Microline 14 x 14 | 20W/m | G448

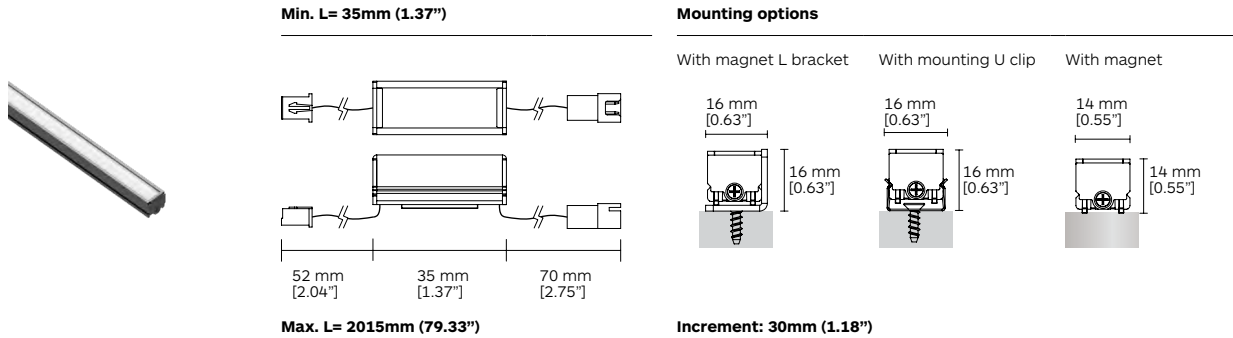

Available length codes

LED Power	Length code	Length in mm	Length in inches	Nominal Lumen	LED Power	Length code	Length in mm	Length in inches	Nominal Lumen	LED Power	Length code	Length in mm	Length in inches	Nominal Lumen
0.60W	0035	35	1.38	63 lm	14.40W	0725	725	28.54	1316 lm	28.20W	1415	1415	55.71	2568 lm
1.20W	0065	65	2.56	118 lm	15.00W	0755	755	29.72	1370 lm	28.80W	1445	1445	56.89	2623 lm
1.80W	0095	95	3.74	172 lm	15.60W	0785	785	30.91	1425 lm	29.40W	1475	1475	58.07	2677 lm
2.40W	0125	125	4.92	227 lm	16.20W	0815	815	32.09	1479 lm	30.00W	1505	1505	59.25	2731 lm
3.00W	0155	155	6.10	281 lm	16.80W	0845	845	33.27	1534 lm	30.60W	1535	1535	60.43	2786 lm
3.60W	0185	185	7.28	336 lm	17.40W	0875	875	34.45	1588 lm	31.20W	1565	1565	61.61	2840 lm
4.20W	0215	215	8.46	390 lm	18.00W	0905	905	35.63	1642 lm	31.80W	1595	1595	62.80	2895 lm
4.80W	0245	245	9.65	445 lm	18.60W	0935	935	36.81	1697 lm	32.40W	1625	1625	63.98	2949 lm
5.40W	0275	275	10.83	499 lm	19.20W	0965	965	37.99	1751 lm	33.00W	1655	1655	65.16	3004 lm
6.00W	0305	305	12.01	553 lm	19.80W	0995	995	39.17	1806 lm	33.60W	1685	1685	66.34	3058 lm
6.60W	0335	335	13.19	608 lm	20.40W	1025	1025	40.35	1860 lm	34.20W	1715	1715	67.52	3113 lm
7.20W	0365	365	14.37	662 lm	21.00W	1055	1055	41.54	1915 lm	34.80W	1745	1745	68.70	3167 lm
7.80W	0395	395	15.55	717 lm	21.60W	1085	1085	42.72	1969 lm	35.40W	1775	1775	69.88	3222 lm
8.40W	0425	425	16.73	771 lm	22.20W	1115	1115	43.90	2024 lm	36.00W	1805	1805	71.06	3276 lm
9.00W	0455	455	17.91	826 lm	22.80W	1145	1145	45.08	2078 lm	36.60W	1835	1835	72.24	3330 lm
9.60W	0485	485	19.09	880 lm	23.40W	1175	1175	46.26	2133 lm	37.20W	1865	1865	73.43	3385 lm
10.20W	0515	515	20.28	935 lm	24.00W	1205	1205	47.44	2187 lm	37.80W	1895	1895	74.61	3439 lm
10.80W	0545	545	21.46	989 lm	24.60W	1235	1235	48.62	2241 lm	38.40W	1925	1925	75.79	3494 lm
11.40W	0575	575	22.64	1044 lm	25.20W	1265	1265	49.80	2296 lm	39.00W	1955	1955	76.97	3548 lm
12.00W	0605	605	23.82	1098 lm	25.80W	1295	1295	50.98	2350 lm	39.60W	1985	1985	78.15	3603 lm
12.60W	0635	635	25.00	1152 lm	26.40W	1325	1325	52.17	2405 lm	40.20W	2015	2015	79.33	3657 lm
13.20W	0665	665	26.18	1207 lm	27.00W	1355	1355	53.35	2459 lm					
13.80W	0695	695	27.36	1261 lm	27.60W	1385	1385	54.53	2514 lm					

Notes:

* For driver information, please see page 84.

Complete Length Codes List

Microline 14 x 14 Chain | 1.20W/Link | G440



Min. L= 65mm (2.55"), 1 Link

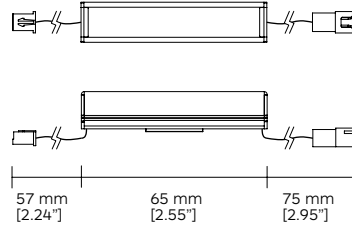

Max. L= 2990mm (117.71"), 40 Links

Mounting options

With magnet L bracket

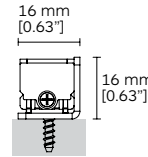

With mounting U clip

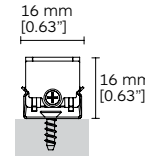

With magnet

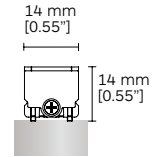

Increment: 75mm (2.95"), 1 Link

Available length codes

No. of Links	LED Power	Length code	Length in mm	Length in inches	Nominal Lumen
1	1.20W	0065	65	2.56	118 lm
2	2.40W	0140	140	5.51	236 lm
3	3.60W	0215	215	8.46	354 lm
4	4.80W	0290	290	11.42	472 lm
5	6.00W	0365	365	14.37	590 lm
6	7.20W	0440	440	17.32	708 lm
7	8.40W	0515	515	20.28	826 lm
8	9.60W	0590	590	23.23	944 lm
9	10.80W	0665	665	26.18	1062 lm
10	12.00W	0740	740	29.13	1180 lm
11	13.20W	0815	815	32.09	1298 lm
12	14.40W	0890	890	35.04	1416 lm
13	15.60W	0965	965	37.99	1534 lm
14	16.80W	1040	1040	40.94	1652 lm
15	18.00W	1115	1115	43.90	1770 lm
16	19.20W	1190	1190	46.85	1888 lm
17	20.40W	1265	1265	49.80	2006 lm
18	21.60W	1340	1340	52.76	2124 lm
19	22.80W	1415	1415	55.71	2242 lm
20	24.00W	1490	1490	58.66	2360 lm
21	25.20W	1565	1565	61.61	2478 lm
22	26.40W	1640	1640	64.57	2596 lm
23	27.60W	1715	1715	67.52	2714 lm
24	28.80W	1790	1790	70.47	2832 lm
25	30.00W	1865	1865	73.43	2950 lm
26	31.20W	1940	1940	76.38	3068 lm
27	32.40W	2015	2015	79.33	3186 lm
28	33.60W	2090	2090	82.28	3504 lm
29	34.80W	2165	2165	85.24	3422 lm
30	36.00W	2240	2240	88.19	3540 lm
31	37.20W	2315	2315	91.14	3658 lm
32	38.40W	2390	2390	94.09	3776 lm
33	39.60W	2465	2465	97.05	3894 lm
34	40.80W	2540	2540	100.00	4012 lm
35	42.00W	2615	2615	102.95	4130 lm
36	43.20W	2690	2690	105.91	4248 lm
37	44.40W	2765	2765	108.86	4366 lm
38	45.60W	2840	2840	111.81	4484 lm
39	46.80W	2915	2915	114.76	4602 lm
40	48.00W	2990	2990	117.72	4720 lm

Notes:

* For driver information, please see page 84.

Complete Length Codes List

Microline 14 x 14 Corner | 20W/m | G459

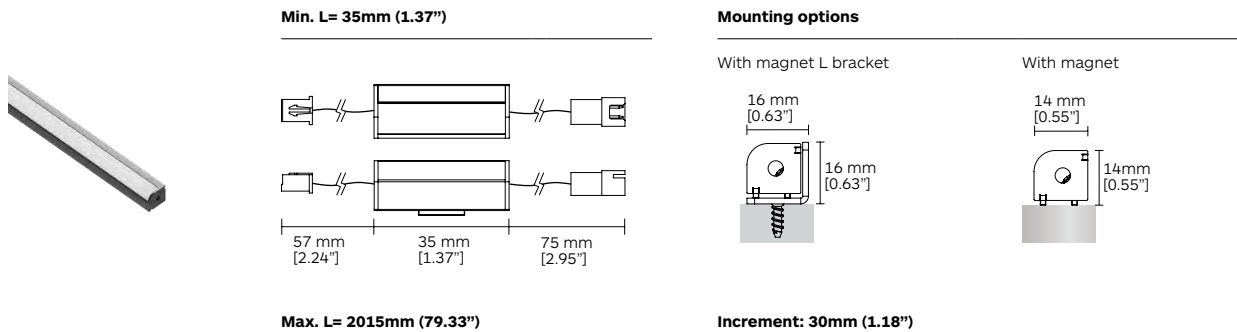

Available length codes

LED Power	Length code	Length in mm	Length in inches	Nominal Lumen	LED Power	Length code	Length in mm	Length in inches	Nominal Lumen	LED Power	Length code	Length in mm	Length in inches	Nominal Lumen
0.60W	0035	35	1.38	63 lm	14.40W	0725	725	28.54	1316 lm	28.20W	1415	1415	55.71	2568 lm
1.20W	0065	65	2.56	118 lm	15.00W	0755	755	29.72	1370 lm	28.80W	1445	1445	56.89	2623 lm
1.80W	0095	95	3.74	172 lm	15.60W	0785	785	30.91	1425 lm	29.40W	1475	1475	58.07	2677 lm
2.40W	0125	125	4.92	227 lm	16.20W	0815	815	32.09	1479 lm	30.00W	1505	1505	59.25	2731 lm
3.00W	0155	155	6.10	281 lm	16.80W	0845	845	33.27	1534 lm	30.60W	1535	1535	60.43	2786 lm
3.60W	0185	185	7.28	336 lm	17.40W	0875	875	34.45	1588 lm	31.20W	1565	1565	61.61	2840 lm
4.20W	0215	215	8.46	390 lm	18.00W	0905	905	35.63	1642 lm	31.80W	1595	1595	62.80	2895 lm
4.80W	0245	245	9.65	445 lm	18.60W	0935	935	36.81	1697 lm	32.40W	1625	1625	63.98	2949 lm
5.40W	0275	275	10.83	499 lm	19.20W	0965	965	37.99	1751 lm	33.00W	1655	1655	65.16	3004 lm
6.00W	0305	305	12.01	553 lm	19.80W	0995	995	39.17	1806 lm	33.60W	1685	1685	66.34	3058 lm
6.60W	0335	335	13.19	608 lm	20.40W	1025	1025	40.35	1860 lm	34.20W	1715	1715	67.52	3113 lm
7.20W	0365	365	14.37	662 lm	21.00W	1055	1055	41.54	1915 lm	34.80W	1745	1745	68.70	3167 lm
7.80W	0395	395	15.55	717 lm	21.60W	1085	1085	42.72	1969 lm	35.40W	1775	1775	69.88	3222 lm
8.40W	0425	425	16.73	771 lm	22.20W	1115	1115	43.90	2024 lm	36.00W	1805	1805	71.06	3276 lm
9.00W	0455	455	17.91	826 lm	22.80W	1145	1145	45.08	2078 lm	36.60W	1835	1835	72.24	3330 lm
9.60W	0485	485	19.09	880 lm	23.40W	1175	1175	46.26	2133 lm	37.20W	1865	1865	73.43	3385 lm
10.20W	0515	515	20.28	935 lm	24.00W	1205	1205	47.44	2187 lm	37.80W	1895	1895	74.61	3439 lm
10.80W	0545	545	21.46	989 lm	24.60W	1235	1235	48.62	2241 lm	38.40W	1925	1925	75.79	3494 lm
11.40W	0575	575	22.64	1044 lm	25.20W	1265	1265	49.80	2296 lm	39.00W	1955	1955	76.97	3548 lm
12.00W	0605	605	23.82	1098 lm	25.80W	1295	1295	50.98	2350 lm	39.60W	1985	1985	78.15	3603 lm
12.60W	0635	635	25.00	1152 lm	26.40W	1325	1325	52.17	2405 lm	40.20W	2015	2015	79.33	3657 lm
13.20W	0665	665	26.18	1207 lm	27.00W	1355	1355	53.35	2459 lm					
13.80W	0695	695	27.36	1261 lm	27.60W	1385	1385	54.53	2513 lm					

Notes:

* For driver information, please see page 84.

Complete Length Codes List

Microline Spot | G426



Min. L= 85mm (3.34"), 2 LED

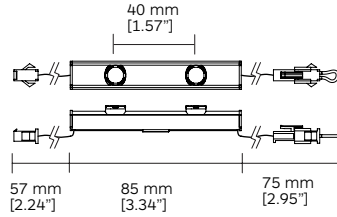

Max. L= 1285mm (50.59"), 32 LEDs

Mounting options

With magnet L bracket

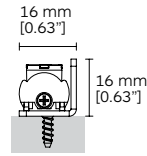

With mounting U clip

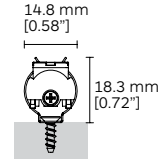

With magnet



Increment: 80mm (3.14"), 2 LEDs

Available length codes

No. of LEDs	Voltage	LED Power	Length code	Length in mm	Length in inches	Nominal Lumen	No. of LEDs	Voltage	LED Power	Length code	Length in mm	Length in inches	Nominal Lumen
2	3.2V	2.00W	0085	85	3.35	180 lm	18	28.8V	18.00W	0725	725	28.54	1620 lm
4	6.4V	4.00W	0165	165	6.50	360 lm	20	32V	20.00W	0805	805	31.69	1800 lm
6	9.6V	6.00W	0245	245	9.65	540 lm	22	35.2V	22.00W	0885	885	34.84	1980 lm
8	12.5V	8.00W	0325	325	12.80	720 lm	24	38.4V	24.00W	0965	965	37.99	2160 lm
10	16V	10.00W	0405	405	15.94	900 lm	26	41.6V	26.00W	1045	1045	41.14	2340 lm
12	19.2V	12.00W	0485	485	19.09	1080 lm	28	44.8V	28.00W	1125	1125	44.29	2520 lm
14	22.4V	14.00W	0565	565	22.24	1260 lm	30	48V	30.00W	1205	1205	47.48	2700 lm
16	25.6V	16.00W	0645	645	25.39	1440 lm	32	51.2V	32.00W	1285	1285	50.59	2880 lm

Notes:

* For driver information, please see page 84.

Complete Length Codes List

Microline Spot Chain | G438

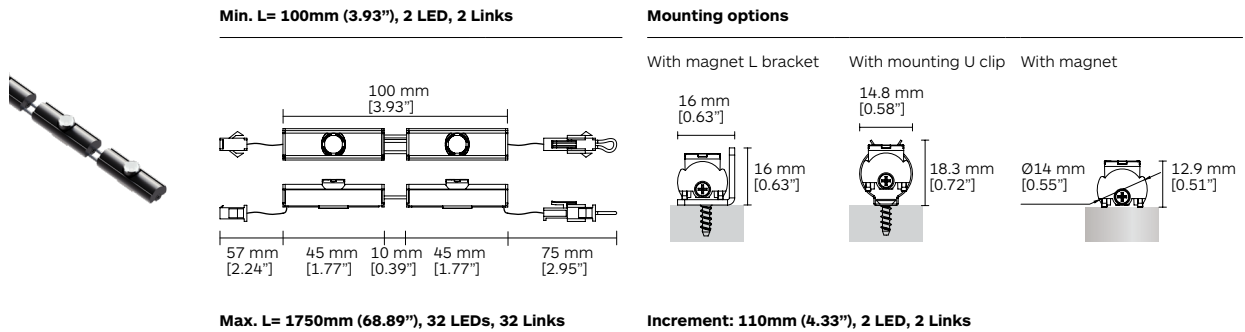

Available length codes

No. of Links	Voltage	LED Power	Length code	Length in mm	Length in inches	Nominal Lumen	No. of Links	Voltage	LED Power	Length code	Length in mm	Length in inches	Nominal Lumen
2	3.2V	2.00W	0100	100	3.93	180 lm	18	28.8V	18.00W	0980	980	38.58	1620 lm
4	6.4V	4.00W	0210	210	8.26	360 lm	20	32V	20.00W	1090	1090	42.91	1800 lm
6	9.6V	6.00W	0320	320	12.59	540 lm	22	35.2V	22.00W	1200	1200	47.24	1980 lm
8	12.5V	8.00W	0430	430	16.92	720 lm	24	38.4V	24.00W	1310	1310	51.57	2160 lm
10	16V	10.00W	0540	540	21.25	900 lm	26	41.6V	26.00W	1420	1420	55.90	2340 lm
12	19.2V	12.00W	0650	650	25.59	1080 lm	28	44.8V	28.00W	1530	1530	60.23	2520 lm
14	22.4V	14.00W	0760	760	29.92	1260 lm	30	48V	30.00W	1640	1640	64.56	2700 lm
16	25.6V	16.00W	0870	870	34.25	1440 lm	32	51.2V	32.00W	1750	1750	68.89	2880 lm

Notes:

* For driver information, please see page 85.

Driver Options

Driver Options

Constant Voltage

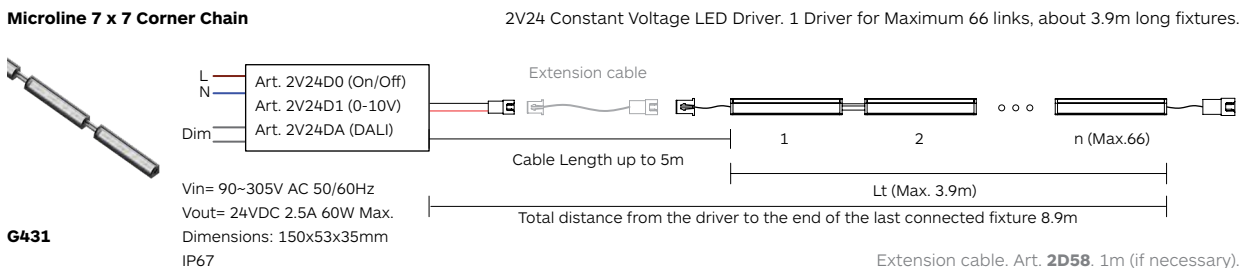
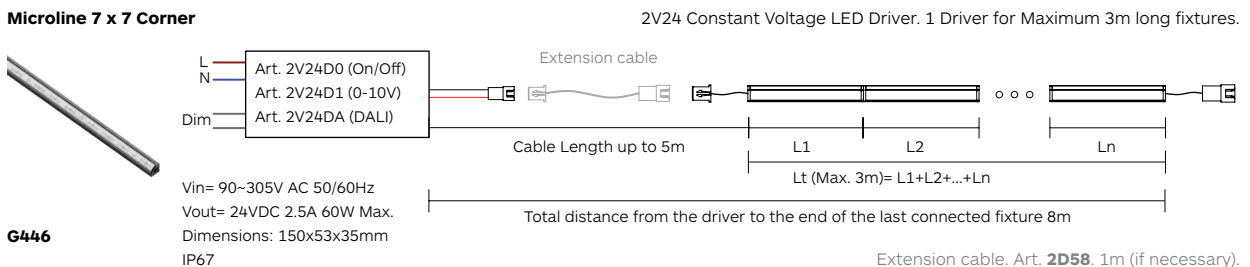
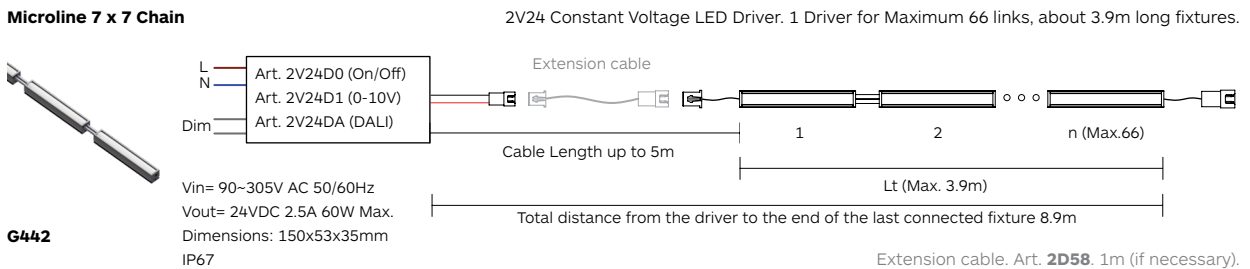
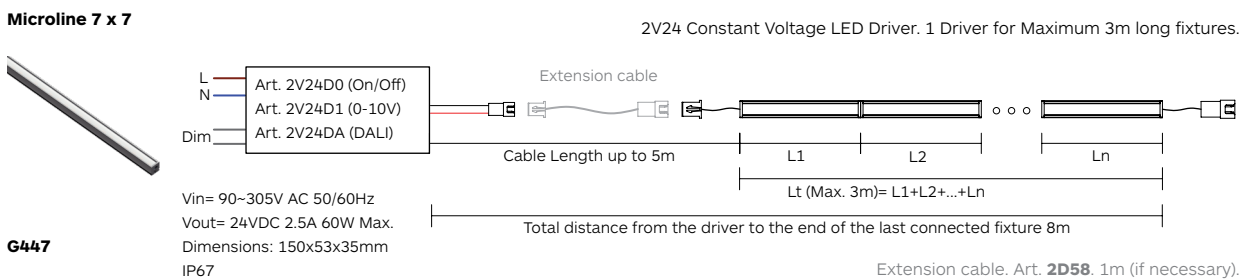
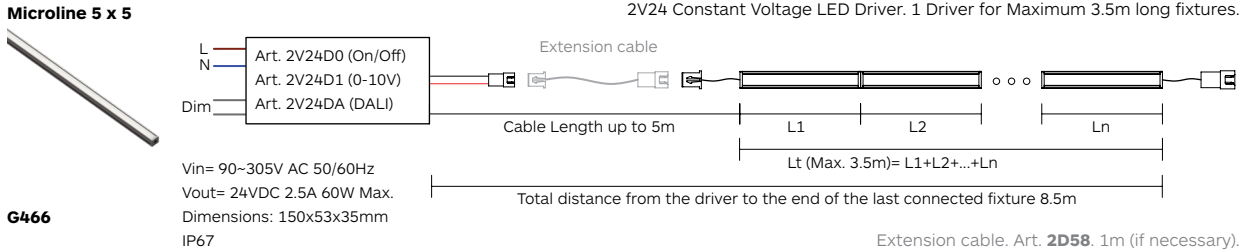

Notes:

* For complete code ordering information, please see page 91.

Driver Options

Constant Voltage

Microline 10 x 6 2V24 Constant Voltage LED Driver. 1 Driver for Maximum 3.5m long fixtures.

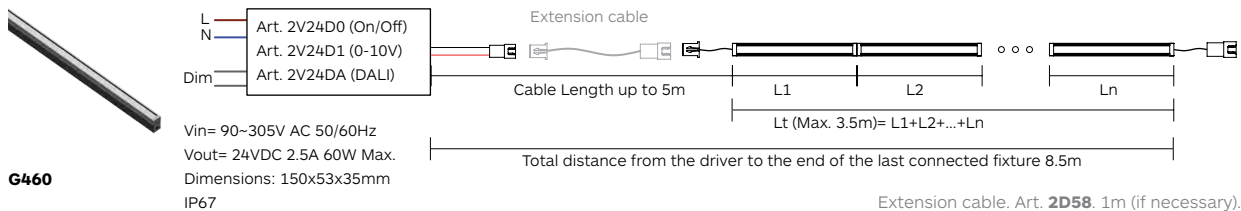

Microline 9 x 8 2V24 Constant Voltage LED Driver. 1 Driver for Maximum 3.5m long fixtures.

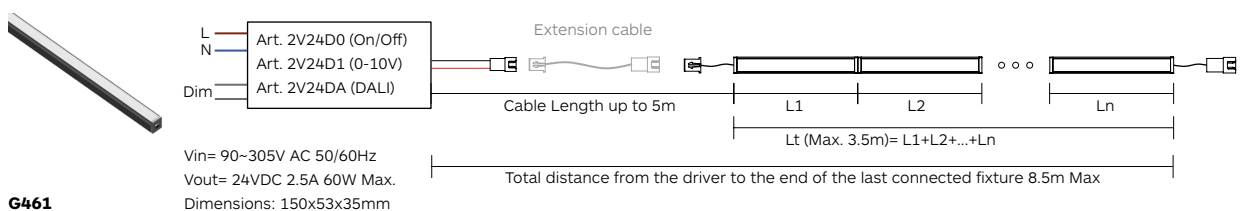

Microline Ø9 2V24 Constant Voltage LED Driver. 1 Driver for Maximum 3.35m long fixtures.

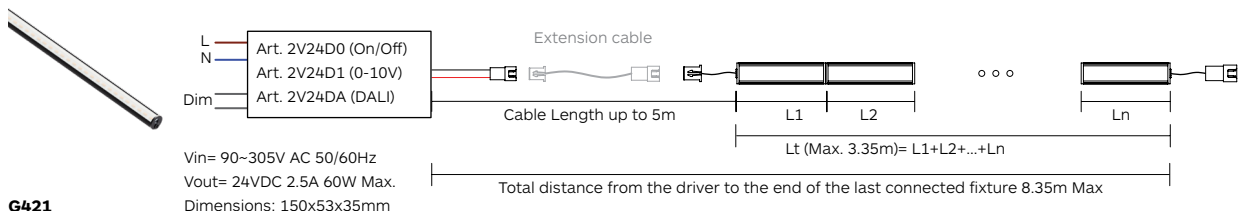

Microline Ø14 2V24 Constant Voltage LED Driver. 1 Driver for Maximum 3.5m G445 / 2.85m G420 / 1.9m G422 long fixtures.

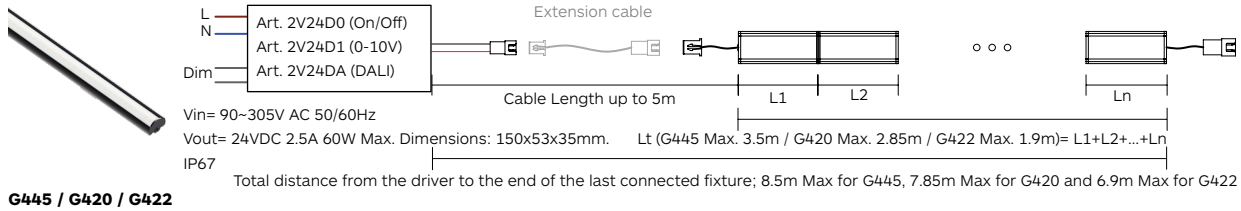

Microline Ø14 Chain 2V24 Constant Voltage LED Driver. 1 Driver for Maximum 47 links G435 about 3.5m / 32 links G436 about 2.4m long fixtures.

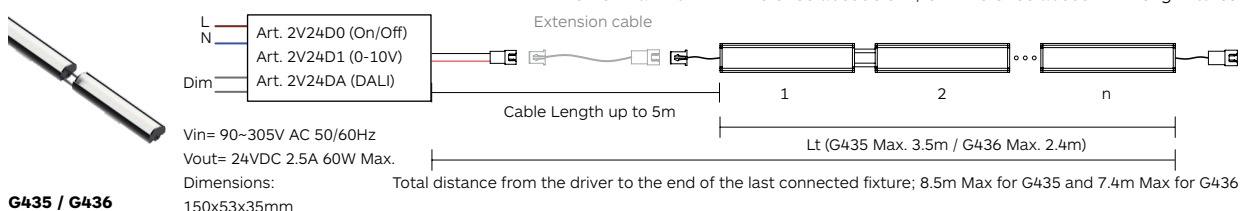

Notes:
 * For complete code ordering information, please see page 91.

Driver Options

Constant Voltage

Microline 14 x 14

2V24 Constant Voltage LED Driver. 1 Driver for Maximum 2.85m long fixtures.

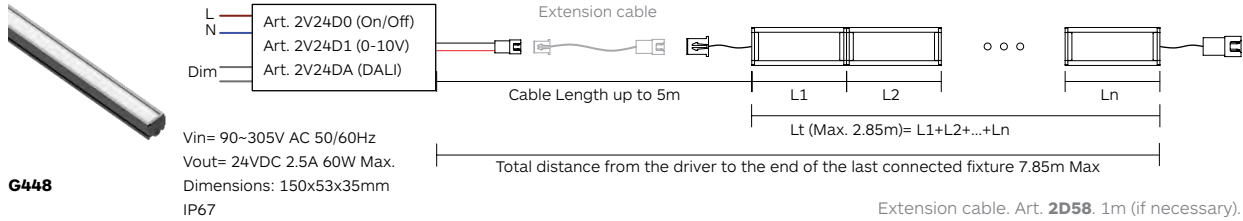

Microline 14 x 14 Chain

2V24 Constant Voltage LED Driver. 1 Driver for Maximum 47 links about 3.5m long fixtures.

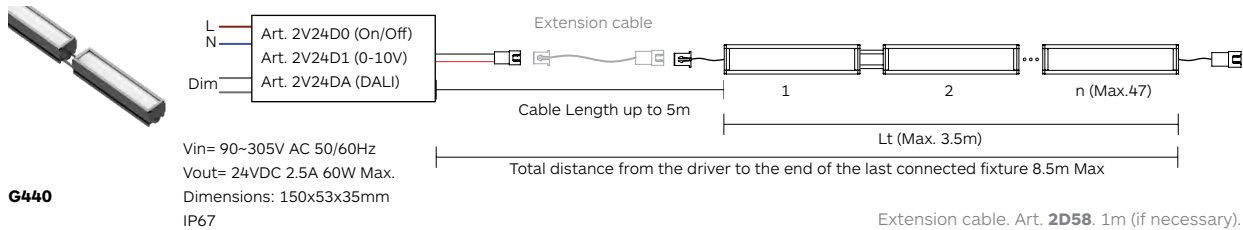

Microline 14 x 14 Corner

2V24 Constant Voltage LED Driver. 1 Driver for Maximum 2.85m long fixtures.

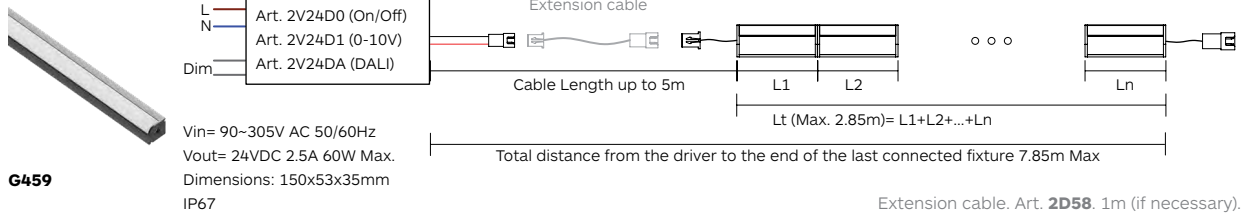

Constant Current

Microline Spot

2C07 Constant Current LED Driver. 1 Driver can drive 2-32 LEDs, about 1285mm Max.

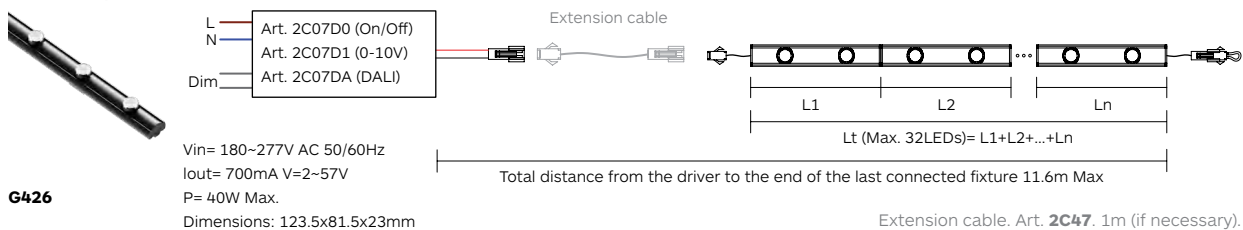

Notes:

* For complete code ordering information, please see page 91.

Driver Options

Constant Current

Microline Spot Chain

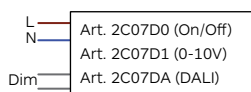

Vin= 180~277V AC 50/60Hz
 Iout= 700mA V=2~57V
 P= 40W Max.
 Dimensions: 123.5x81.5x23mm

G438

2C07 Constant Current LED Driver. 1 Driver can drive 2-32 LEDs, about 1750mm Max.

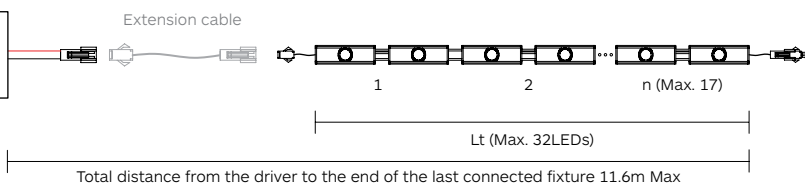

Extension cable. Art. **2C47**. 1m (if necessary).

Mini Cobra Linealuce

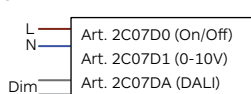

Vin= 180~277V AC 50/60Hz
 Iout= 700mA V=2~57V
 P= 40W Max.
 Dimensions: 123.5x81.5x23mm

G451

2C07 Constant Current LED Driver. 1 Driver can drive 2-32LEDs, about 965mm Max.

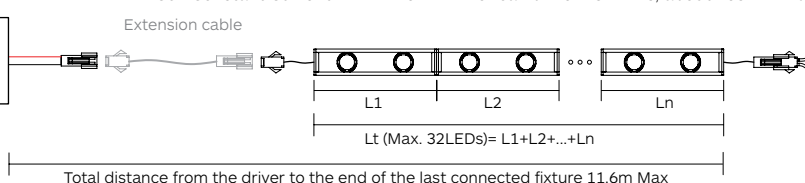

Extension cable. Art. **2C47**. 1m (if necessary).

Mini Cobra Flex

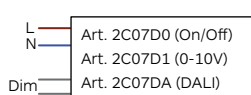

Vin= 180~277V AC 50/60Hz
 Iout= 700mA V=2~57V
 P= 40W Max.
 Dimensions: 123.5x81.5x23mm

G430

2C07 Constant Current LED Driver. 1 Driver can drive 2-32 LEDs, about 956mm Max.

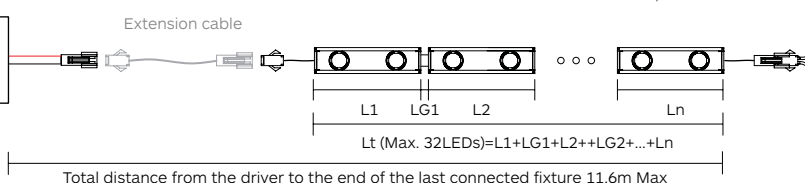

Extension cable. Art. **2C47**. 1m (if necessary).

Mini Cobra Linealuce Louvre

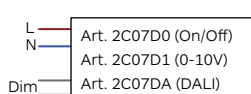

Vin= 180~277V AC 50/60Hz
 Iout= 700mA V=2~57V
 P= 40W Max.
 Dimensions: 123.5x81.5x23mm

G452

2C07 Constant Current LED Driver. 1 Driver can drive 2-32LEDs, about 965mm Max.

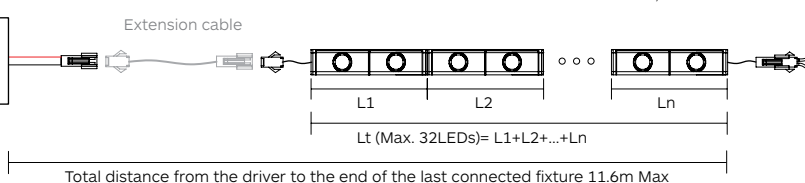

Extension cable. Art. **2C47**. 1m (if necessary).

Mini Cobra Flex Louvre

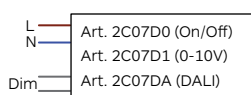

Vin= 180~277V AC 50/60Hz
 Iout= 700mA V=2~57V
 P= 40W Max.
 Dimensions: 123.5x81.5x23mm

G439

2C07 Constant Current LED Driver. 1 Driver can drive 2-32LEDs, about 956mm Max.

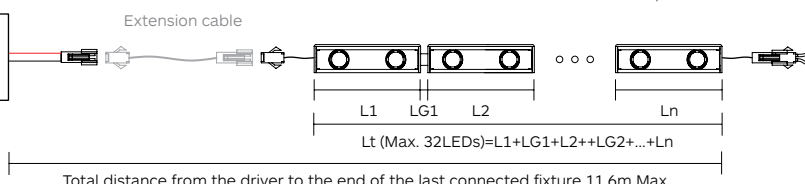

Extension cable. Art. **2C47**. 1m (if necessary).

Notes:

* For complete code ordering information, please see page 91.

Driver Options

Constant Current

Mini Cobra Pro

2C07 Constant Current LED Driver. 1 Driver can drive 2-32LEDs, about 962mm Max.

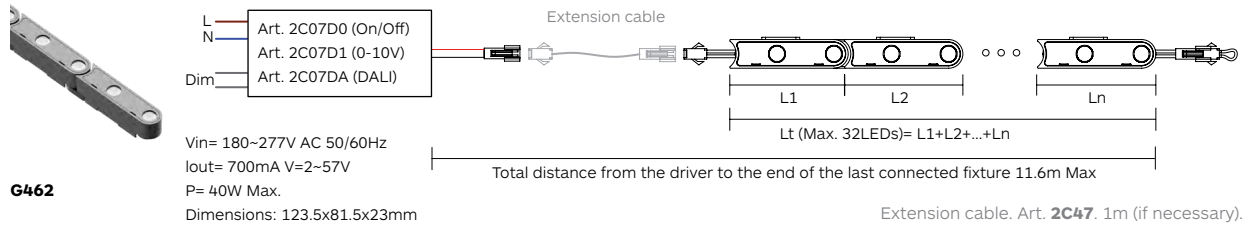

Mini Cobra Pro Louvre

2C07 Constant Current LED Driver. 1 Driver can drive 2-32LEDs, about 962mm Max.

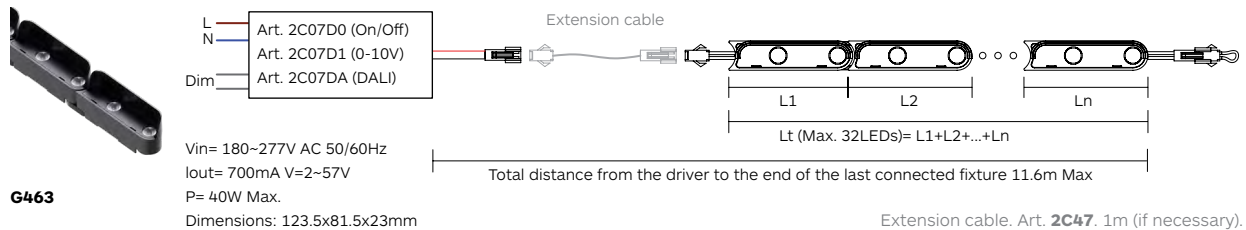

Cobra Linealuce

2C02 Constant Current LED Driver. 1 Driver can drive 4-32LEDs, about 960mm Max.

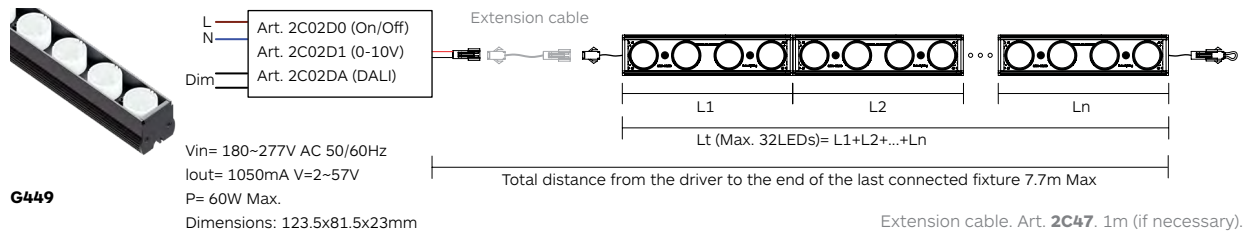

Cobra Flex

2C02 Constant Current LED Driver. 1 Driver can drive 2-32LEDs, about 954mm Max.

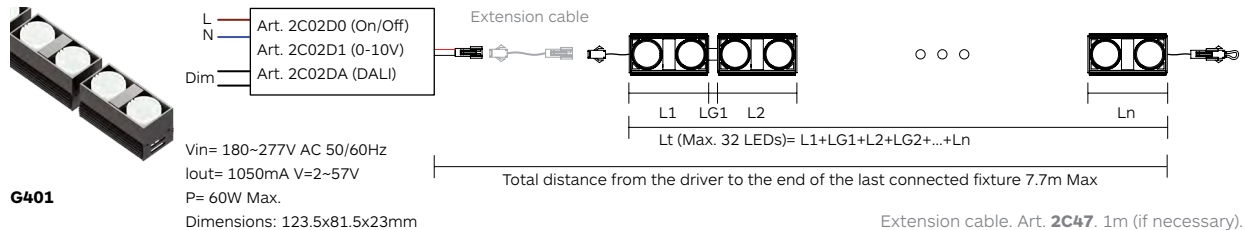

Cobra Linealuce Louvre

2C02 Constant Current LED Driver. 1 Driver can drive 4-32LEDs, about 960mm Max.

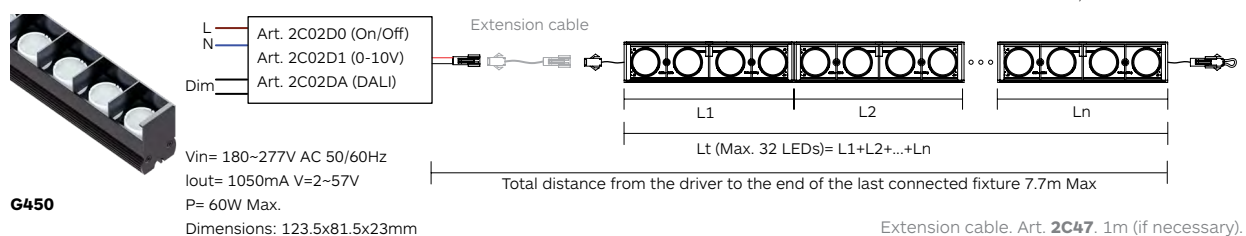

Notes:

* For complete code ordering information, please see page 91.

Driver Options

Constant Current

Cobra Flex Louvre

2C02 Constant Current LED Driver. 1 Driver can drive 2-32LEDs, about 954mm Max.

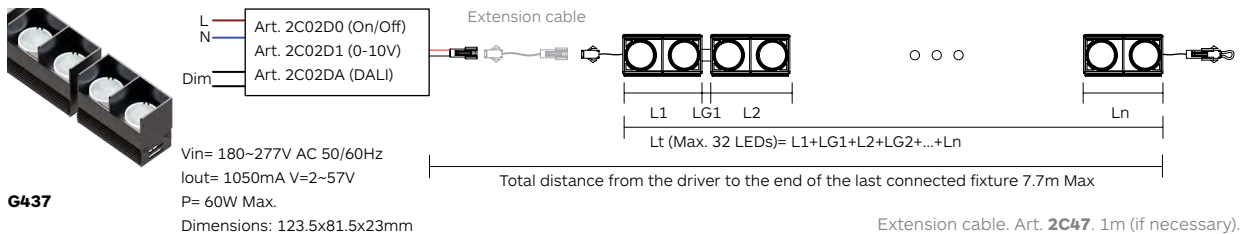

Cobra Pro IP66

Constant Current LED Driver. 1 Driver can drive 2-32LEDs, about 1223mm Max.

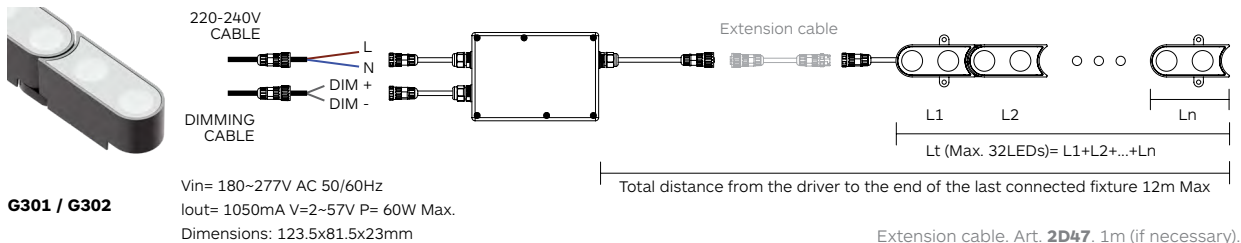

Accessories

Product / Accessories	Louvre Colour 10	Honeycomb Colour 10	Honeycomb Colour 10	Narrow Bracket Adjustable Colour 10	Wide Bracket Adjustable Colour 10
Mini Cobra Linealuce	/	/	2D97	/	/
Mini Cobra Flex	/	/		/	/
Mini Cobra Pro	/	/		2D03	2D04
Mini Cobra Pro Louvre	/	/	/		
Cobra Linealuce	/	2D88	/	/	/
Cobra Flex	/		/	/	/
Cobra Pro IP66 Fixed	2C97	/	/	/	/
Cobra Pro IP66 Adjustable		/	/	/	/

* Please refer to the user manuals for further details.

Notes:

* For complete code ordering information, please see page 91.

Symbols & Icons

Code system

Global presence

Symbols & Icons

Trim Round	
Trim Square	
Trimless Round	
Trimless Square	
Round ceiling cut	
Square ceiling cut	

The CE mark signifies that a product conforms with the relevant ECC directives requirements. The CE marking is compulsory to indicate LVD and EMC conformity.

The CE mark is also a self certification that the manufacturer claims that the product is safe. The value of such claim is directly related to the case of FormaLighting: All products are designed, developed, manufactured under the scope of ISO 9001 quality systems.



All formaLighting products are tested in Europe and certified by an independent laboratory that is registered and audited by an approved European testing authority.

Others third party product approvals

Our products include electrical and electronic components that carry other world wide Test House approvals such as those shown:



CLASS I

Luminaires of insulation Class I - with earth connector.



CLASS II

Luminaires of insulation Class II - With safety isolation, this means the tension conduction element are protected by additional isolation.

The isolation of an earth wire it is not necessary and the connection to it is not allowed.



CLASS III

Luminaires of insulation Class III - designed for operation of protected low voltage supply (>42V).



Passes the 850C glow wire test in accordance with ICE 695-2-1.



Passes the 960C glow wire test in accordance with ICE 695-2-1.



Degree of Ingress Protection*



Dim2Warm



Tuneable White



Recyclable



IP__ Degree of Ingress Protection

1st Number	Protection Against Dust and Solid Objects	2nd Number	Protection Against Moisture and Liquids
0	No-Protection	0	No-Protection
1	Protection against solid objects >50 mm	1	Protection against dripping water
2	Protection against solid objects >12 mm	2	Protection against dripping water tilted > 15 deg
3	Protection against solid objects >2.5 mm	3	Protection against spraying water > 30 deg
4	Protection against solid objects >1 mm	4	Protection against spraying water
5	Dust - protected	5	Protection against water jet
6	Dust - tight	6	Protection against waves
		7	Protection against the effects of immersion
		8	Protection against submersion

Level of Shock Resistance

IK00	Not protected	IK00
IK01	Protected against 0.15 J shocks	IK01
IK02	Protected against 0.2 J shocks	IK02
IK03	Protected against 0.35 J shocks	IK03
IK04	Protected against 0.5 J shocks	IK04
IK05	Protected against 0.7 J shocks	IK05
IK06	Protected against 1 J shocks	IK06
IK07	Protected against 2 J shocks	IK07
IK08	Protected against 5 J shocks	IK08
IK09	Protected against 10 J shocks	IK09
IK10	Protected against 20 J shocks	IK10

Code system

Code ordering examples:

Microline 5 x 5: **G 4 4 6 0 0 5 5 . 9 7 2 7 R D 0 0 1 0**

Cobra Pro IP66 Adjustable: **G 3 0 2 0 0 8 3 . 9 0 2 7 1 7 D 0 1 0**

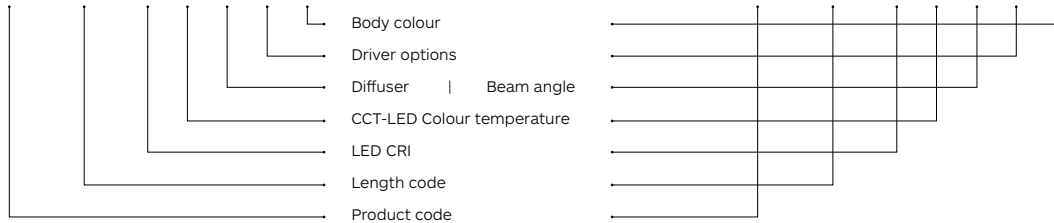

LED CRI

- 90** CRI > 90
- 97** CRI > 97

Driver Options

- 00** No Driver
- D0** No dimming
- DA** Dali Dim
- DX** DMX
- DC** CASAMBI
- D1** 0-10 Dim

Body Colour

- 10** Black
- 79** Natural Aluminium

CCT-LED Colour temperature

- 27** Warm White 2700K
- 30** Warm White 3000K
- 35** Warm White 3500K
- 40** Neutral White 4000K
- TW** Tuneable White 1800K - 6000K

Diffuser Options

- OD** Opal diffuser
- TD** Transparent lenticular diffuser
- RD** Opal rigid diffuser

RGB

RGBW

How to order

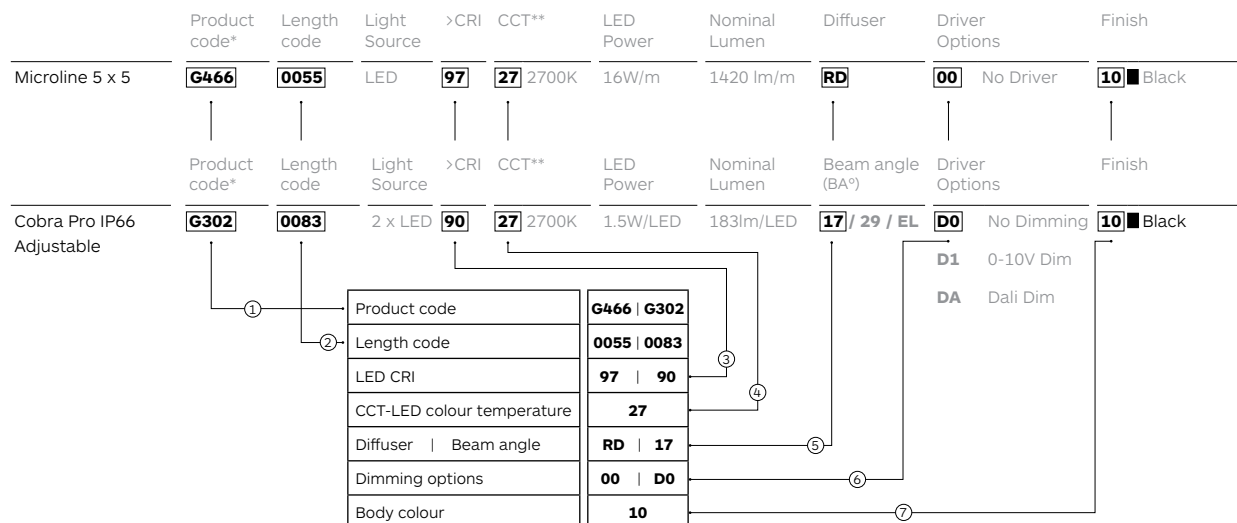

All dimensions in the catalogue in mm and inches.

Global presence

Celebrating 50 years of vision, dedication and innovation, Formalighting's versatile and high-quality product offerings extends internationally via our headquarters in Hong Kong, London, Milan, Shanghai and the USA.

Our well chosen and selected partners as well as our affiliated international offices broaden our global presence further in markets such as Australia, Japan, South East Asia, India and the Middle East.

Through our commitment to growth and investment within formalighting's professional team, infrastructure and product ranges, we are able to provide increasing service to our global retail and hospitality clients as well as lighting designers and specifiers strengthening our position as a leading international supplier of innovative architectural lighting solutions and systems.

With 50 years' experience in designing and manufacturing architectural lighting, formalighting's comprehensive portfolio offers a competitive range of European designed and expertly engineered products that carry CB, CE, CCC and UL certifications.

Furthermore formalighting's latest award-winning motorized range of track, pendant, and recessed fixtures, featuring remote-controlled adjustable pan and tilt, dim, dim to warm, tuneable white and beam shaping lens, are available worldwide incorporating the latest, most advanced lighting technologies.

Headquarters

Europe / Milan

Tel (+39) 02 9354 0300

Fax (+39) 02 9343 5117

E-mail formaitalia@formalighting.it

Asia / Hong Kong

Tel (+852) 2516 6500

Fax (+852) 2516 6525

E-mail forma@forma.com.hk

USA / New York

Tel (+1) 470 419 4003

E-mail info.us@formalighting.com

Formalighting is constantly developing and improving its products therefore all information, drawings illustrations, specifications, photometric values in this catalogue are indicative and shall not form part of any commitment to our company that reserve the right to change specifications without prior notification or public announcement. Technical information on the installation-instruction has precedence over the information in the catalogue. Our general terms and conditions shall apply notwithstanding any stipulation on the contrary to all the orders and agreement with formalighting. You can obtain a copy of these conditions on demand.

Publication date: March 2020
©Copyright formalighting

With thank to all contributors for the realization of this catalogue

Designed by formalighting Graphic Design Department

No part of this catalogue may be copied without written authorization of formalighting

formalighting

HONG KONG

-

LONDON

-

MILAN

-

SHANGHAI

-

NEW YORK

formalighting

MOTOLUX

Motorized Remote Controlled Lighting

2020 | 21

MOTOLUX

Motorized Remote Controlled Lighting

48V Low Voltage Track

Moto-Zero



26

New

Moto-Zero **Zoom**



28

New

Main Voltage Track

Moto-Zero
Compasso



32

Moto-Zero
Compasso **Zoom**
(Integrated Driver)



34

New

Moto-Zero &
Moto-Zero **Zoom**



36

New

Recessed

Moto-Ola



40

Moto-Polaris



42

Moto-Combo &
Moto-Combo **Zoom**



44

New

Moto-Venus



46

Moto-Zero In & Out



52

Moto-Palla In & Out



54

Surface

Pendant

Moto-Colosseo



58

New

Moto-Gimbalo &
Moto-Gimbalo **Zoom**



60

New

Moto-MultiGimbalo &
Moto-MultiGimbalo **Zoom**



62

Moto-Flap



68

New

Moto-Gimbalo
Surface



70

Moto - Gimbalo
Pendant



72

Outdoor

Track Systems & Accessories

Sistema
Moto-MultiGimbalo



74

Moto-LineaVolo

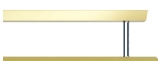

76

New

Moto-Terraluce



Landscape

78

Low Voltage Track
Options

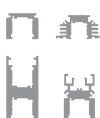

85

Power Supply



90

Eurotype Track
System



92

formalighting

MOTOLUX a smart, affordable and complete solution for aiming and focusing lighting, without a ladder or lift. With MOTOLUX, formalighting brings the latest innovations in motorized lighting to the forefront.

Formalighting designed MOTOLUX specifically for the architectural market with design, form, and function as the foundation to servicing specific lighting needs across multiple applications in retail, hospitality, museum and commercial environments.

Historically, the motorized lighting used in commercial environments came from the theatrical world where the products were derived from large format expensive stage lights limiting their use to niche applications, typically in areas with little to no access.

By using its best-selling products as base, formalighting created compact motorized lighting, which are accessible for all applications offering the benefits and peculiarities of quality architectural fixtures that can be remotely panned, tilted and dimmed. Furthermore, it will be possible to remotely adjust the colour temperature and the beam angle of the fixture. All of this, for only a small increment in price.

In short, formalighting has created a versatile remote controlled series of motorized architectural lighting, MOTOLUX, that is ideal for applications in all the dynamic environments as well as where the distance between the ceiling and the surface to illuminate is an issue.

Eliminated the need for ladders and lifts, MOTOLUX delivers 3 Key benefits:

Reduced Costs

Light refocusing is done, most of the time, after normal working hours, which results in overtime costs. Maintenance staff or outside contractors have to be brought in to refocus the lighting. MOTOLUX eliminates this by simplifying the process and making safe and easy for anyone to refocus lighting.



Limits Liability

Since ladders or expensive scaffolds are not anymore required, it is safe and easy for ANY employee to adjust the lighting, reducing potential liability issues of work place accidents. The motor are silent and include a mechanical safety clutch to prevent any possible damage in the event of being operated manually

Updated Lighting

Our motorized architectural lighting fixtures help to ensure lighting is focused where and when is needed. It is extremely easy for any person to make the necessary changes and adjustments with a touch on a smart-device's screen using our app or with a click on a button of our patented remote control.



The Future of Light is moving

MOTOLUX
Motorized Remote Controlled Lighting





Central control

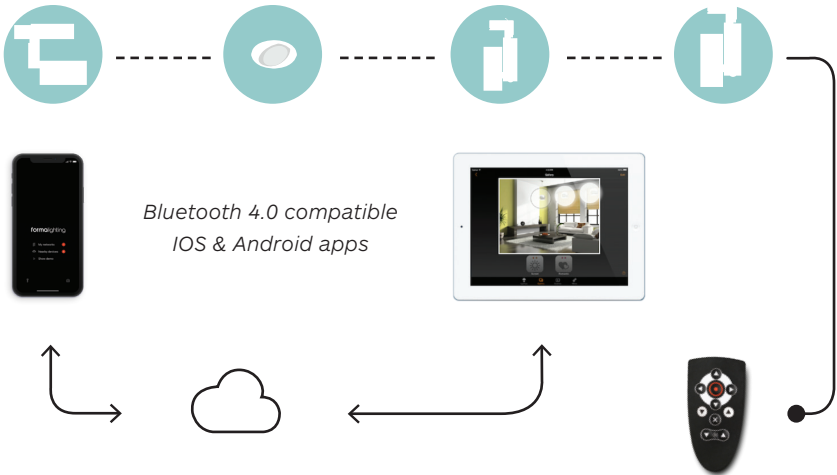

1. Not all fixtures must be by formalighting.
2. Dimming functions accure throughout the day for various reasons; often many times per day.
3. Casambi gives up control of dimming functions to Central System so formalighting's fixtures do not require a secondary controller for dimming.

Remote control, sensor data, SW updates, configuration.

Not all environments are the same. We understand this so we developed the full remote control MOTOLUX motorized architectural fixtures with the flexibility to be controlled in many different ways. Whether through one of our control method, Casambi app or LaserDim Remote Control or a third party centralized system (i.e. DALI) combined with one of our control method.

Our first method of control is our hand held remote called "Laser Dim". This gives you the capability to Pan, Tilt, Dim and even to change the light color, when applicable, of a single or multiple fixtures at one time. In this scenario, rather than grabbing a ladder and climbing to the top, you simply pull your remote out of the drawer and point and click your way to re-focused lighting.

Secondly, formalighting's Bluetooth enabled application, powered by Casambi, offers the same functionality of Laser Dim combined with advanced

smart lighting features. If Laser Dim equates to the ladder, this option is a smart ladder. Our Casambi based applications has many of the same functions of popular centralized control systems in that is capable creating and memorizing Zones and Scenes as well as executing timer based commands for formalighting products, but it is also capable of controlling non formalighting fixtures through the use of simple click on modules.

The third and most popular from of control is a hybrid where MOTOLUX, like any other architectural fixture, can be dimmed via a third party system using phase or 0-10v dimming protocols. In this scenario dimming commands which happen many times a day for various reasons and possibly even from various inputs are executed as desired, but less frequent refocusing needs are handled by one of the two options above.

Casambi & formalighting

The Casambi solution is based on Bluetooth Low Energy, the state-of-the-art wireless technology and the only low power wireless technology in all modern smartphones, tablets and even smart watches, making it the only mainstream and future proof low power radio technology in the world.

Casambi technology provides a self-organizing wireless mesh network able to control a large number of fixtures from any point. It also allows for firmware updates over the network, allowing any kind of changes to be made over-the-air. In this kind of fully distributed and symmetric architecture, any unit can go offline and catch up from others when they return back online.

Formalighting app by Casambi works as one of the user interfaces in a Casambi lighting control solution, as the commissioning tool and as well as a remote gateway. The app works with iOS as well as Android devices, like smartphones, tablets and smartwatches. The app is free to download by any end user.

The Casambi app is made by user interface experts and in a way, that anyone - regardless of technical proficiency- can use it. Thanks to the formalighting app by Casambi it will be possible for the users to control the pan and tilt movement of the MOTOLUX fixtures, dimming the intensity of the light, easily use special features such as TuneableWhite, DimToWarm, RGB/W and Zoom beam shaping.

The app will only show in the user interface the functionality that is relevant for the fixtures used in the specific project. Therefore, the Casambi app is equally suitable for the professional lighting market as well as the residential field. The Casambi devices are smart on their own and they connect only when is needed.

An Internet connection is not necessary for normal operation, it is only needed for user interface configurations to be sent or recalled from the cloud service.

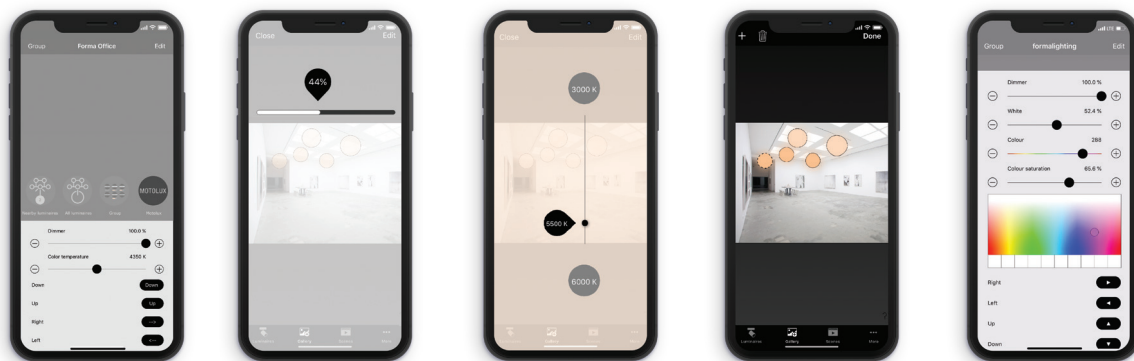

CASAMBI

Easy Configuration

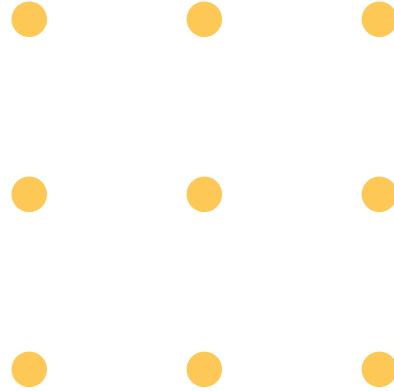
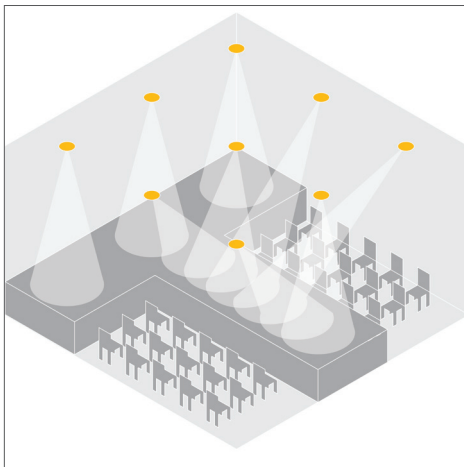
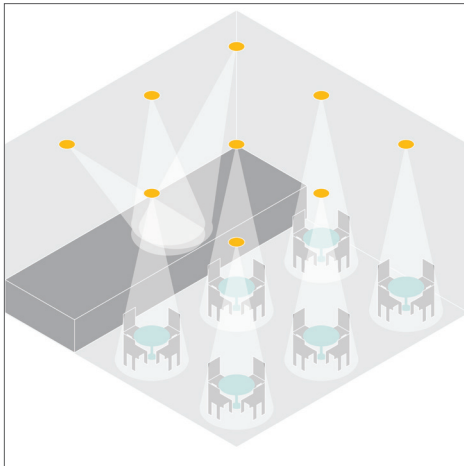
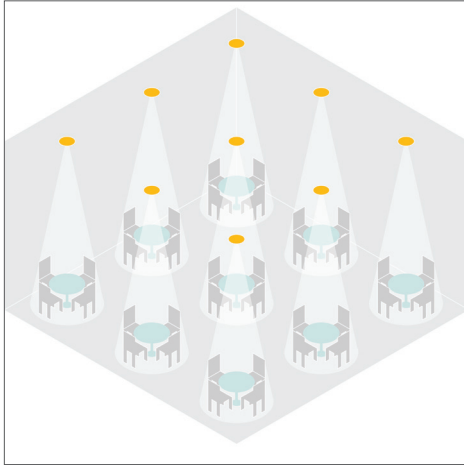

We introduce an easy and precised way to control and configure our luminaries. Using the MOTOLUX app powered by Casambi, it will be easy and fast to create scenes involving dimerization, colour tuning and fixtures movements.

After saving it any scene can be recall with a simple click. Multiple scenes can be saved in the app, to adapt the illumination to the different time of the day or the different use of the ambience to enlighten.

One sigle installation with endless possibilities:

- **Create and save a specific scene.**
- **Change scenes at any time digitally.**
- **Program differente scenes to be changed automatically at a time set.**

Key Features

Zoom. Change of beam angle

Every. Angle. Covered.



For unparalleled flexibility, selected MOTOLUX fixtures incorporate yet beam-shaping lens, to focus the luminaires beam angle from narrow to diffuse wide, giving the designers and the users the possibility to easily reconfigure the same ambience according with different type of events. Now you have many choice with one fixture.

Beam Angles

Ultra spot, narrow, medium and wide beam

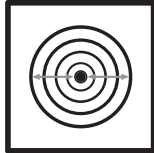

Different light distributions offer freedom in design. For this reason, MOTOLUX luminaires are offered with different beam angles, ranging from ultra-spot to wide or flood, depending on the light source selected. Ultra-spot illumination allows to sharp focus on specific area or objects. Another advantage is the possibility to delivers good illumination from high ceiling.

Pan & Tilt

Move light head remotely

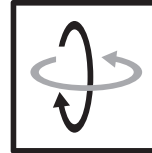

With dual axis hot aiming, the pan and tilt of any MOTOLUX fixture are easily controlled and instantly revised via a Bluetooth application or a user-friendly hand held remote control. It will be no longer necessary to hire maintenance technical staff, using ladders or operating complicate mechanical scaffolds, only to reconfigure the ambience's illumination.

Tuneable White

Human Centric Light



In response to the gradual shifts in colour temperature of natural light throughout the course of a day and a season, MOTOLUX luminaires offer also a Tuneable White fixture. The white colour temperature of the light can be adjusted in 2700-6500K range. The right temperature at every moment of the day and for every event.

RGB / RGBW

Millions of colour shades



Another option of the advanced MOTOLUX LED light engines is RGBW. Fixtures with RGBW allow the possibility to change the light colour in a range of over 15 shades. Using high end optics the MOTOLUX RGBW luminaires deliver a uniform and shadow free light effect, making them an ideal solution for retail and shop window applications.

Full Spectrum (Sunlight)

Just like the sunlight



Full Spectrum modules offer the possibility to imitate like never before the spectrum of the sunlight, giving the designer the opportunity to create dramatic effects and playing with the whole natural colour spectrum. The full spectrum fixtures displayed any subject in a real natural light or been optimized with gradients of off-Planckian colours.

Connectivity

Mesh Network



MOTOLUX powered by Casambi provides an organized wireless mesh network able to control infinite numbers of fixtures, where all the intelligence of the system is replicated in every single fixture. In this kind of fully distributed and symmetric architecture, with no single points of failure, any unit can go offline and catch up from others when it return back online.

Bluetooth

All its power in your hands



Thanks to the formalighting app powered by Casambi it will be possible for the users to control, via smartphone or tablet, the pan and tilt movement of the MOTOLUX fixtures, dimming the intensity of the light, easily use special features such as Full Spectrum colour regulation, Tuneable White and beam shaping focus. Furthermore it will be possible create or recall specific light scene.

Remote Control

Simply Life



One fixtures or Infinite fixtures, only one patented remote control. Use the device to take the control of the scene. Point the controller to the dome of a luminaire (from a distance of up to 12 meters) and push the button, the dome will turn green. It will be possible to tilt/pan the fixtures, regulate the intensity and the temperature of the light with a touch of a button.

Full control

Take control of the scene

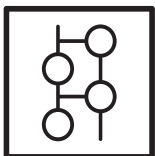

MOTOLUX technology makes easy to control multiple luminaires together. This operation is simple with both control methods, smart device app and patented remote control. User can group the luminaires and control their movements, light intensity and light temperature together. With Casambi it will be possible to create scene involving the luminaire group.

Multi Dim

Add colour to your life

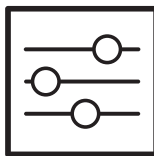

MOTOLUX fixtures powered by Casambi offer a comprehensive colour controlling possibility. User can change the light colour in a simple way via the app interface. It will be possible to choose between many different gradients and save the favourite colours in a personalized colour palette.

Switchable

Easy control

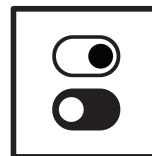

MOTOLUX luminaires powered by Casambi can also be controlled from standard wall switches and push buttons without the Casambi app. A standard wall switch or a push button can be used for dimming, controlling a scene or to swap through several scenes. In this way, there is no need to install additional dimmers.



Beam Shaping (BS)

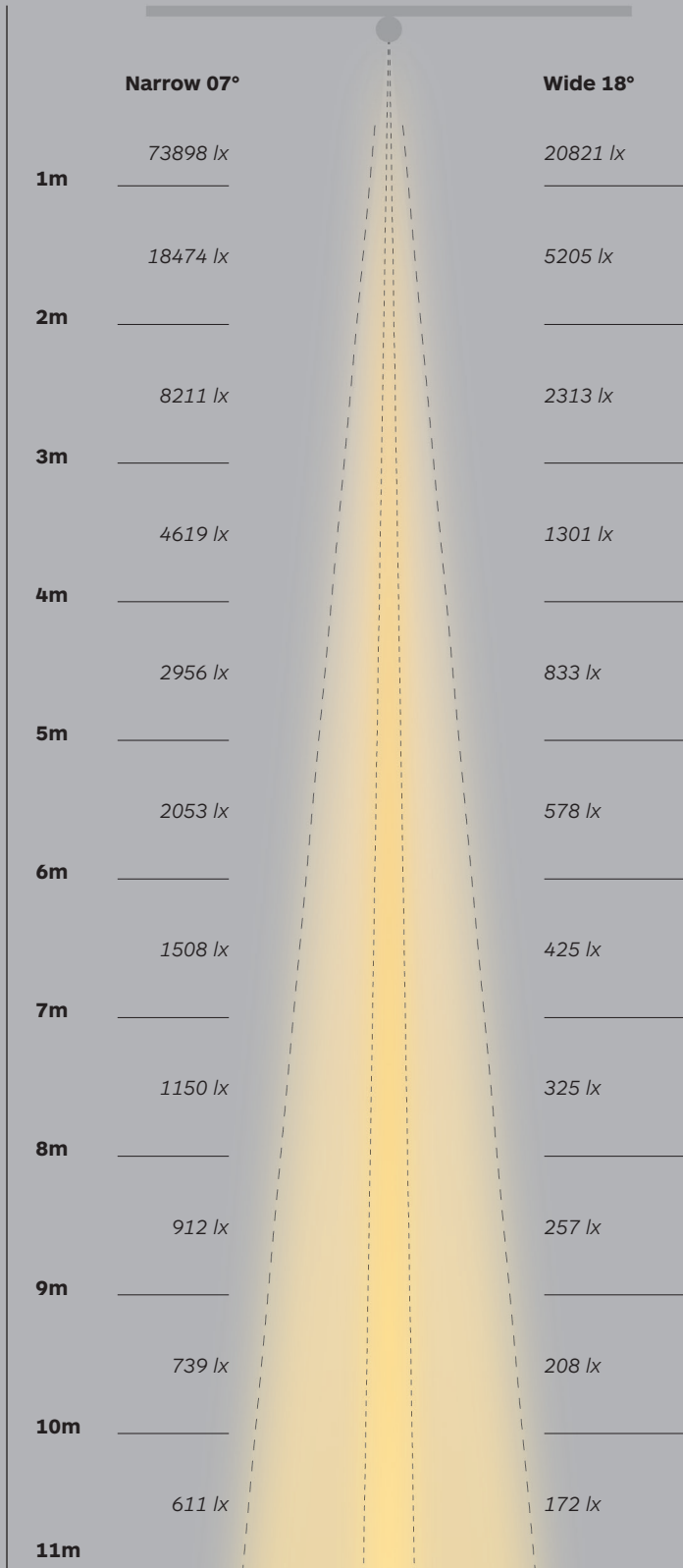

Every. Angle. Covered.

Each MOTOLUX luminaire is offered in an option of at least two different beam angles, ranging from narrow to wide or flood, depending on the light source selected.

For unparalleled flexibility, MOTOLUX introduces the new Zoom options, for selected fixtures. Based on pioneering beam-shaping lens technology, the Zoom option allows the user to adjust the luminaires' beam angle from narrow to diffuse wide, giving the possibility to reconfigure the same ambience according with the type of event.

Using the MOTOLUX Zoom luminaires, designers and users can create dynamic lighting scenario and precisely focus the light beam on specific zone or objects. The Zoom option is also the ideal solution to deliver to the floor a higher quantity of lux.

Zoom Spotlights

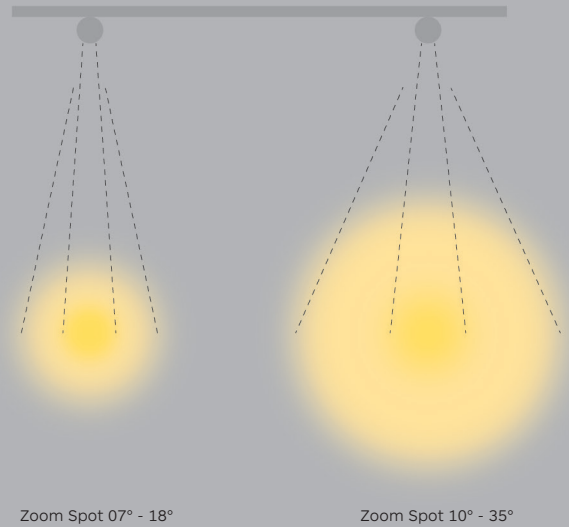

Full Spectrum Covered by Lumenetix

Full color Spectrum via wireless control technology by Lumenetix allows designers to solve the problem of ambience requiring multiple colour illumination. With selected MOTOLUX fixtures incorporated the revolutionary Lumenetix lighting technology is possible to solve the problem using only one type of fixtures. The Lumenetix Araya 5 Full-Spectrum LED chips deliver an unparalleled likeness to sunlight's natural spectrum, offering users the opportunity to create dramatic scenographic effects to communicate a variety of emotive experiences. The MOTOLUX are supplied with Casambi Bluetooth as standard control option; others protocols such as Dali-0 10V and DMX are available upon request.

lumenetix® CASAMBI





MOTOLUX powered by Lumenetix engine are able to deliver perfectly mixed white light, using five different colours channel of high, broad spectrum, brightness, none of which is white. The delivered light is 2 SCDM about the Planckian curve at 90+ CRI across the tuning range. MOTOLUX Lumenetix provides unique and different lighting solutions for each and every requirement. One fixture. one room...one building.

Areas of Application

Museums / Galleries



Related products

Moto-Zero Low Voltage Track
Moto-Zero Zoom Low Voltage Track
Moto-Zero Compasso Main Voltage Track
Moto-Zero Zoom Main Voltage Track
Moto-Zero Main Voltage Track
Moto-Ola
Moto-Zero In & Out
Moto-Gimbalo Pendant

Banquets Hall



Related products

Moto-Zero Low Voltage Track
Moto-Zero Zoom Low Voltage Track
Moto-Zero Compasso Main Voltage Track
Moto-Zero Zoom Main Voltage Track
Moto-Zero Main Voltage Track
Moto-Ola
Moto-Combo
Moto-Palla In & Out
Moto-Colosseo
Moto-Gimbalo
Moto-MultiGimbalo
Moto-Gimbalo Surface
Sistema Moto-MultiGimbalo

Shop Windows & Retail



Related products

Moto-Zero Low Voltage Track
Moto-Zero Zoom Low Voltage Track
Moto-Zero Compasso Main Voltage Track
Moto-Zero Zoom Main Voltage Track
Moto-Zero Main Voltage Track
Moto-Ola
Moto-Palla In & Out
Moto-Colosseo
Moto-Gimbalo
Moto-MultiGimbalo
Moto-Gimbalo Surface
Sistema Moto-MultiGimbalo

High ceiling



Related products

Moto-Zero Low Voltage Track
Moto-Zero Zoom Low Voltage Track
Moto-Zero Compasso Main Voltage Track
Moto-Zero Zoom Main Voltage Track
Moto-Zero Main Voltage Track
Moto-Ola
Moto-Combo
Moto-Venus
Moto-Zero In & Out
Moto-Palla In & Out
Moto-Colosseo
Moto-Gimbalo
Moto-MultiGimbalo
Moto-Gimbalo Surface
Sistema Moto-MultiGimbalo

Hospitality / Restaurants



Related products

Moto-Zero Low Voltage Track
Moto-Zero Zoom Low Voltage Track
Moto-Zero Compasso Main Voltage Track
Moto-Zero Zoom Main Voltage Track
Moto-Zero Main Voltage Track
Moto-Ola
Moto-Flap
Moto-LineaVolo

High end residentials / Living spaces



Related products

Moto-Zero Low Voltage Track
Moto-Zero Zoom Low Voltage Track
Moto-Zero Compasso Main Voltage Track
Moto-Zero Zoom Main Voltage Track
Moto-Zero Main Voltage Track
Moto-Ola
Moto-Venus
Moto-Palla In & Out
Moto-Colosseo
Moto-Flap
Moto-Gimbalo Pendant
Sistema Moto-MultiGimbalo
Moto-LineaVolo

Project References

Since the 2016 series launch, over 18,000 Motolux fixtures have been installed in over 300 different projects around the world. Motolux's technologically advanced, remote controlled motorized

lighting fixtures deliver the most flexible and reliable solutions for a wide range of projects and applications for Hospitality, Retail, Museums, Art Galleries, Restaurants and many more.

Retail

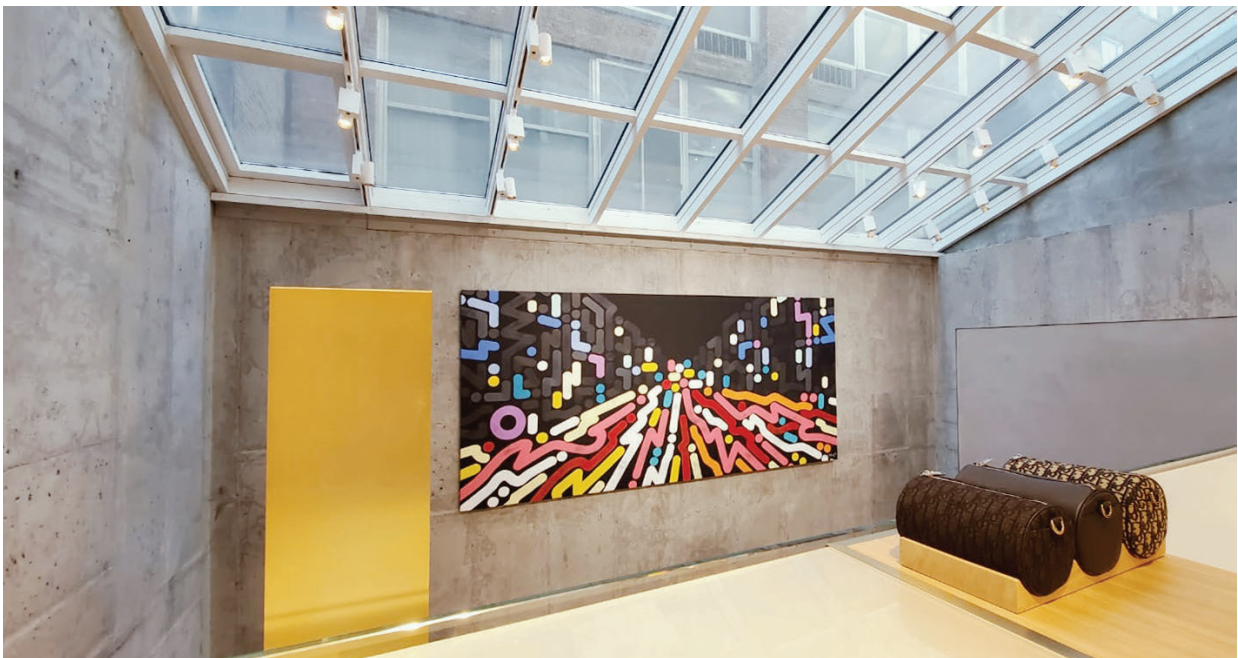

Retail space.
New York.

Banquets Hall



*Banquets Hall.
Dubai.*

Hospitality

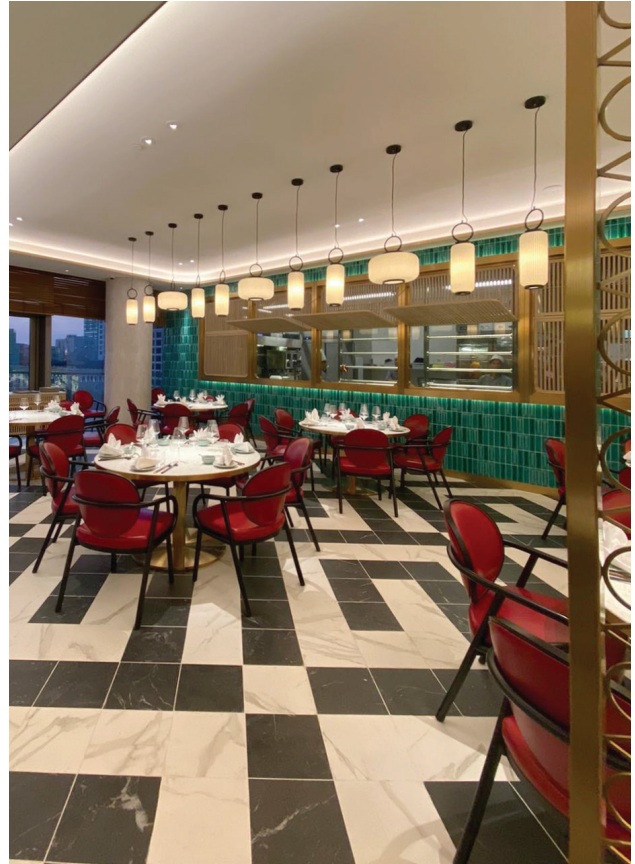

Restaurant.
Macau.

Museums / Art Galleries



Art Gallery Project.
Manila.

MOTOLUX for 48V Low Voltage Track System

Moto Zero's family of remote controlled motorized track lighting is now including specific 48V versions, which offering all the advantage of low-Voltage luminaire.

The fixtures, which include an integrated 48V track adapter, offer all the benefits of the remote controlled MOTOLUX motorized architectural lighting. Moto-Zero LV is available in 3 sizes with aluminium light head diameter of 40mm-66-mm and 100mm. its Zoom version is available in 2 sizes 40mm and 80mm.

Pan + Tilt + Zoom

Two silent DC motors drive the 0-90° tilt and 0- 360° pan movements of the fixture. A third motor enables a high précised focus of the light beam in a range between 12°-45°. The movements and bean shaping of the fixtures, as well as the intensity and the white colour tuning of the light, are controlled via remote control CASAMBI™ application.

2020
product
release

formalighting

formalighting



MOTOLUX

Motorized Remote Controlled Lighting

Motorized Architectural Lighting

Moto-Zero Low Voltage

40 | 68 | 100 Low Voltage Track



Body

Motorized track mounted 48V low voltage spotlight with light head and mounting arm in cast aluminium. Moto-Zero 48V low voltage is available in 3 different light head diameters 40mm and 68mm and 100mm.

The integrated track adapter is compatible with different models of Stucchi low voltage track system. Easy to insert and remove from the track. Two DC motors drive the movements of the fixture, which is tiltable vertically up to 90° and rotatable horizontally 330°.

The movements of the fixture, as well as the intensity and the colour tuning of the light, are controlled via CASAMBI™ application.

Accessories

Moto-Zero 68 & 100: honeycomb louvre. For more information about accessories see page 82 and for low voltage track accessories see page 84-89.

Finish

Powder coat in black or white colour.

LED sources

COB LED. High Power LED. Lumenetix Full Spectrum (68). COB Tuneable White (40, 100). CRI: 90 | CCT: 3000K, 4000K, Full Spectrum (68). Other CRI and CCT options available on request.

Optic

Lens or Reflector (only for Moto-Zero 68 TW). Super narrow (7°), narrow, medium and wide beam angle available.

Driver

48V input integrated. Motion Control: Casambi. Dimming Options: Casambi. Colour Tuning: Casambi. **Power supply** unit to be ordered separately, see page 90.

Applications

The 48V Low Voltage evolution of the Moto-Zero Compasso. Easy to install and to control, a versatile spotlight ideal for retail and museum applications. Application areas: retail, museums, hospitality, residential, lobbies.

Compatible with Low Voltage Track Types

Please see P.84-85 for details

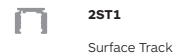

2ST1

Surface Track



2ST6

Surface Track
Pendant Track



2ST7

Recessed Track
For Up Side



2ST8

Recessed Track
Trim



2ST3

Recessed Track
Trimless

Moto-Zero Low Voltage Track



Moto-Zero Low Voltage 40

Low Voltage Track

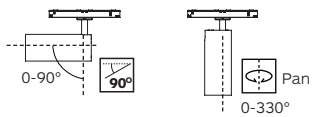
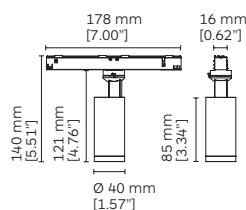

Moto-Zero Low Voltage 68

Low Voltage Track

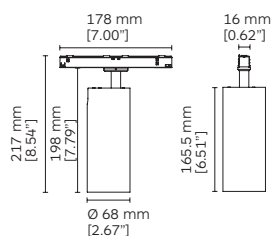

Moto-Zero Low Voltage 100

Low Voltage Track

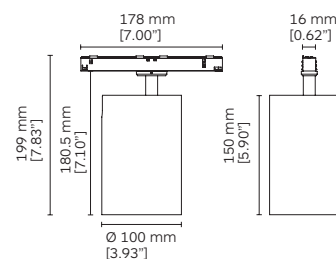

Code ordering example: **M 9 0 1 B C 3 1 - 9 0 3 0 1 6 D C 1 0**

	Product Code	Light Source Code*	>CRI	CCT**	LED Power	Nominal Lumen	Beam Angle (BA°)	Driver Options	Finish
Moto-Zero Low Voltage 40	M901	BC31 COB LED	90	30 3000K	6W	664 lm	16 / 26 / 36	DC CASAMBI	10 ■ Black 11 □ White
		BR21 High Power LED		40 4000K	4W	722 lm	07 / 24 / 36		
		BU11 TW COB LED	TW 2700-6500K	7W	483 lm	18 / 28 / 40			
Moto-Zero Low Voltage 68	M902	BC22 COB LED	90	30 3000K	12W	1550 lm	16 / 25 / 36		
		BR21 High Power LED		40 4000K	6W	530 lm	05		
		BL22 Lumenetix ¹	90	FS Full Spectrum	18W	750 lm	18 / 25 / 33		
		IU21 TW COB LED	TW 2700-6500K	13W	580 lm	16 / 25 / 48			
Moto-Zero Low Voltage 100	M903	BC33 COB LED	90	30 3000K	25W	2760 lm	12 / 22 / 32		
		BR21 High Power LED		40 4000K	21W	3000 lm	07 / 24 / 36		
						1920 lm			

Notes:

* For complete code ordering information, please see page 97.

For related accessories, please see page 82-83 & 84-89.

** For other CCT options, please contact us.

¹ Tuning range: 1650-8000K. Gradients of saturated colours from 1-100% can be added to colour points within the tuning range.

¹ The values in the nominal lumen are referring to the peak lumen.

Moto-Zero Zoom Low Voltage

40 | 80 Low Voltage Track



Body

Motorized track mounted 48V low voltage spotlight with light head and mounting arm in cast aluminium. Moto-Zero Zoom 48V low voltage is available in 2 different light head diameters: 40mm and 80mm. The integrated track adapter is compatible with different models of Stucchi low voltage track system.

Easy to insert and remove from the track. Two DC motors drive the movements of the fixture, which is tiltable vertically up to 90° and rotatable horizontally 350°. A third motor controls a special lens, which allows the user to shape the light beam from narrow to wide diffuse. The movements and the beam shaping of the fixture, as well as the intensity and the colour tuning of the light, are controlled via CASAMBI™ application.

Accessories

For more information about low voltage track accessories see page 84-89.

Finish

Powder coat in black or white colour.

LED sources

High Power LED. (40). COB LED (80). Lumenetix Full Spectrum (80).

CRI: 90 | CCT: 3000K, 4000K, Full Spectrum (80). Other CRI and CCT options available on request.

Optic

Lens.
Adjustable beam angle.

Driver

48V input integrated.
Motion Control: Casambi.
Dimming Options: Casambi.
Colour Tuning: Casambi.
Power supply unit to be ordered separately, see page 90.

Applications

The 48V Low Voltage evolution of the Moto-Zero Zoom. Easy to install and to control, the fixture enable users to focus on a narrow to wide spot at the touch of a button. Application areas: retail, museums, hospitality, residential, lobbies.

Compatible with Low Voltage Track Types

Please see P.84-85 for details

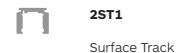

2ST1
Surface Track

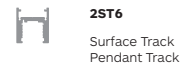

2ST6
Surface Track
Pendant Track



2ST7
Pendant Track
For Up Side



2ST8
Recessed Track
Trim

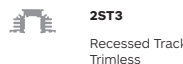

2ST3
Recessed Track
Trimless

Moto-Zero Zoom Low Voltage Track



Moto-Zero Zoom Low Voltage 40

Low Voltage Track



Moto-Zero Zoom Low Voltage 80

Low Voltage Track

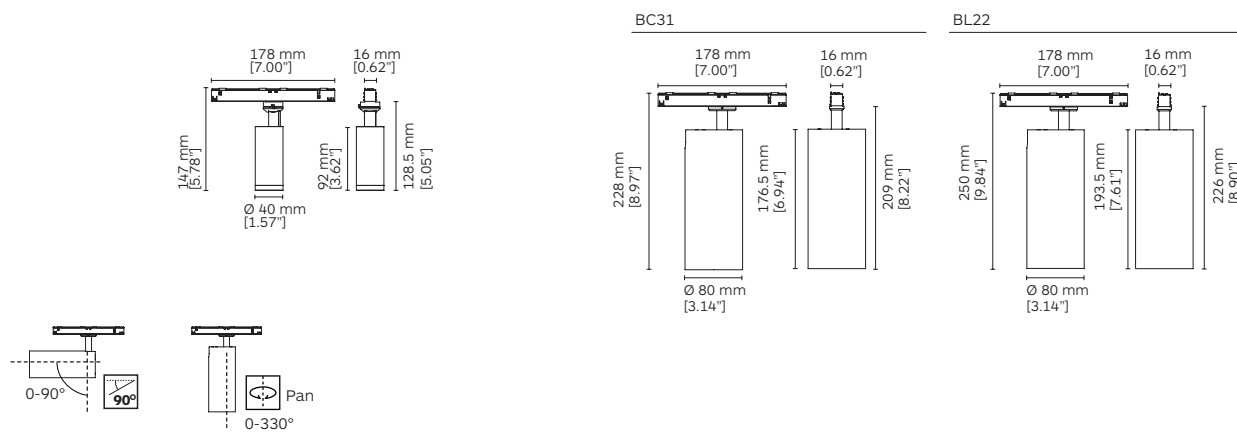

Code ordering example: **M 9 0 4 B R 2 1 - 9 0 3 0 B S D C 1 0**

	Product Code	Light Source Code*	>CRI	CCT**	LED Power	Nominal Lumen	Beam Angle (BA°)	Driver Options	Finish		
Moto-Zero Zoom Low Voltage 40	M904	BR21	High Power LED	90	30	3000K	4W	439 lm	BS (13° - 35°)	DC CASAMBI	10 ■ Black
				40	40	4000K		483 lm			11 □ White
Moto-Zero Zoom Low Voltage 80	M905	BC31	COB LED	90	30	3000K	14W	1410 lm	BS (12° - 45°) ²		
				40	40	4000K		1540 lm			
	BL22	Lumenetix ¹	90	FS	Full Spectrum	18W	750 lm	BS (15° - 45°) ²			

Notes:

* For complete code ordering information, please see page 97.

For related accessories, please see page 84-89.

** For other CCT options, Tuneable White (TW)  version please contact us.

¹ Tuning range: 1650-8000K. Gradients of saturated colours from 1-100% can be added to colour points within the tuning range.

² The values in the nominal lumen are referring to the peak lumen.

BS: Beam shaping.

²Wide angle donotes as field angels.

Motolux for Main Voltage Lighting

Moto-Zero Compasso

40 | 68 | 100



Body

Motorized track mounted spotlight with light head and mounting arm in cast aluminium. **Moto-Zero Compasso** is available in 3 different light head diameters: 40mm, 68mm and 100mm. **Moto-Zero Compasso Zoom** is available in 4 diameters: 40mm, 68mm, 80mm and 130 mm.

The integrated track adapter with built-in driver is compatible with 3 phase eurotype track.

Two DC motors drive the movements of the fixtures, tilting them vertically up to 90° and rotating horizontally 315°.

For the Moto-Zero Zoom series, a third motor controls a special lens, which allows the user to shape the light beam from narrow to wide diffuse.

The movements and the beam shaping of the fixture, as well as the intensity and the colour tuning of the light, are controlled via CASAMBI™ application.

Accessories

Moto-Zero Compasso 68: Honeycomb louvre, Visor, Snoot. **Moto-Zero Zoom 130:** Honeycomb louvre. For more information about accessories see page 82 and for track accessories see page 92-93.

Finish

Powder coat in black or white colour.

LED sources

Moto Zero Compasso: COB LED. High Power LED. Lumenetix Full Spectrum (68). COB Tuneable White (40, 68). CRI: 90 | CCT: 3000K, 4000K, Tuneable White (40, 68), Full Spectrum (68). **Moto-Zero Zoom:** High Power LED. (40). COB LED (68, 80, 130). Lumenetix Full Spectrum (80), Tuneable White (130). CRI: 90 | CCT: 3000K, 4000K, Full Spectrum (80), Tuneable White (130).

Optic

Lens or Reflector (only for Moto-Zero Compasso 68 TW). Super narrow (7°), narrow, medium and wide beam angle available. **Moto-Zero Zoom** series: special lenses with beam-shaping technology.

Driver

Dimmable, In track adapter integrated driver 220-240VAC 50/60hz.
Motion Control: Casambi.
Dimming Options: Casambi.
Colour Tuning: Casambi.

Applications

A tiny and versatile spotlight ideal for applications where the distance between ceiling and spot is an issue. The Moto-Zero Zoom series is the ideal solution for museum and retail application. The fixture enable users to focus on a narrow to wide spot at the touch of a button. Application areas: retail, museums, hospitality, residential, lobbies.

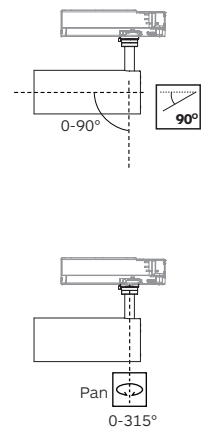

Moto-Zero Compasso



Moto-Zero Compasso 40

Compasso Main Voltage Track

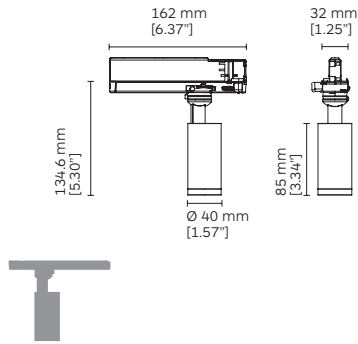

Moto-Zero Compasso 68

Compasso Main Voltage Track

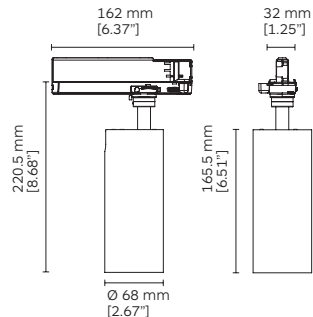

Moto-Zero Compasso 100

Compasso Main Voltage Track

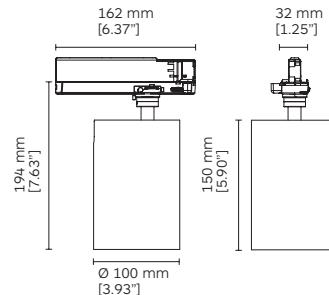

Code ordering example: **M 6 3 9 B C 3 1 - 9 0 3 0 1 6 D C 1 0**

	Product Code	Light Source Code*	>CRI	CCT**	LED Power	Nominal Lumen	Beam Angle (BA°)	Driver Options	Finish
Moto-Zero Compasso 40	M639	BC31 COB LED	90	30 3000K	6W	664 lm	16 / 26 / 36	DC CASAMBI	10 ■ Black 11 □ White
				40 4000K		722 lm			
		BR21 High Power LED		4W	439 lm	07 / 24 / 36			
		BU11 TW COB LED	TW 2700-6500K	7W	710 lm	18 / 28 / 40			
Moto-Zero Compasso 68	M665	BC22 COB LED	90	30 3000K	12W	1550 lm	16 / 25 / 36	DC CASAMBI	10 ■ Black 11 □ White
				40 4000K		1570 lm			
		BR21 High Power LED		6W	530 lm	05			
		BL22 Lumenetix ¹	90	FS Full Spectrum	18W	750 lm	18 / 25 / 33		
Moto-Zero Compasso 100	M666	BC33 COB LED	90	30 3000K	25W	2760 lm	12 / 22 / 32	DC CASAMBI	10 ■ Black 11 □ White
				40 4000K		3000 lm			
		BR21 High Power LED		21W	1862 lm	07 / 24 / 36			
						1920 lm			

Notes:

* For complete code ordering information, please see page 97.

For related accessories, please see page 82-83.

** For other CCT options, please contact us.

¹ Tuning range: 1650-8000K. Gradients of saturated colours from 1-100% can be added to colour points within the tuning range.

¹ The values in the nominal lumen are referring to the peak lumen.

Moto-Zero Zoom



Moto-Zero Compasso Zoom 40

Main Voltage Track

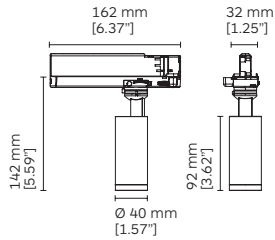

Moto-Zero Compasso Zoom 68

Main Voltage Track

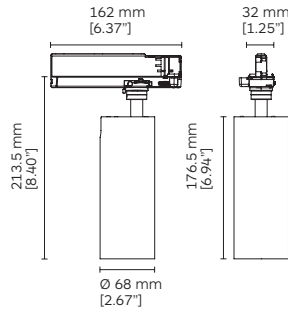

Moto-Zero Compasso Zoom 80

Main Voltage Track

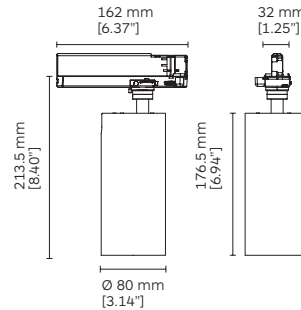

Moto-Zero Zoom 130

Main Voltage Track

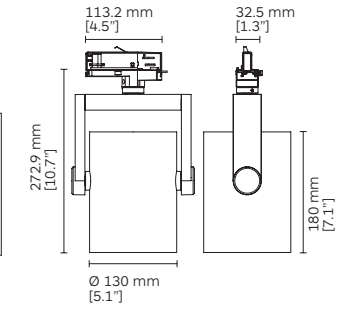

Code ordering example: **M 6 6 7 B R 2 1 - 9 0 3 0 B S D C 1 0**

	Product Code	Light Source Code*	>CRI	CCT**	LED Power	Nominal Lumen	Beam Angle (BA°)	Driver Options	Finish
Moto-Zero Compasso Zoom 40	M667	BR21 High Power LED	90	30 3000K 40 4000K	4W	439 lm 483 lm	BS (11° - 35°)	DC CASAMBI	10 ■ Black 11 □ White
Moto-Zero Compasso Zoom 68	M668	BC31 COB LED	90	30 3000K 40 4000K	14W	1410 lm 1540 lm	BS (10° - 30°) ²		
Moto-Zero Compasso Zoom 80	M669	BC31 COB LED	90	30 3000K 40 4000K	14W	1410 lm 1540 lm	BS (10° - 38°) ²		
		BL22 Lumenetix ¹		FS Full Spectrum	18W	750 lm	BS (15° - 45°) ²		
Moto-Zero Zoom 130	M670	BN21 COB LED	95	30 3000K 40 4000K	30W	2870 lm 3110 lm	BS (07° - 18°)		
		BB31 TW COB LED	90	TW 2700-6500K	26W	2710 lm	BS (13° - 20°)		

Notes:

* For complete code ordering information, please see page 97.

For related accessories, please see page 82-83.

** For other CCT options, please contact us.

¹ Tuning range: 1650-8000K. Gradients of saturated colours from 1-100% can be added to colour points within the tuning range.

² The values in the nominal lumen are referring to the peak lumen.

BS: Beam shaping.

²Wide angle donotes as field angels.

Every. Angle. Covered.



Zoom Spotlights

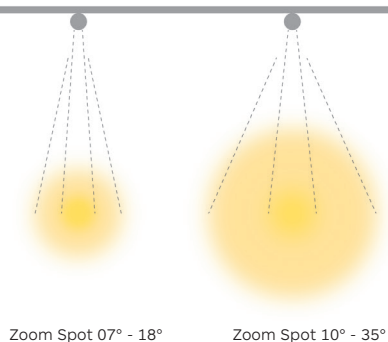

Moto-Zero Zoom, the latest novelty from the award-winning MOTOLUX range, is the ideal lighting solution for spaces with soaring ceilings, that also require frequent scene changes.

Using the formalighting app powered by CASAMBI, the fixture's beam angle can be changed within a range of 7 to 45 degrees. A change in beam angle may also require the light to be re-directed or modify its intensity, so the same app controls the pan (355°), tilt (90°) and dimming of the Moto-Zero Zoom.

Moto-Zero Zoom is available in 4 different sizes (lighthouse diameter of 40cm, 66cm, 80cm, 130cm) and with specific high Color Rendering option (CRI 97+, R9 90+). The range will soon be available in a low voltage track version.

Thanks to MOTOLUX technology, designers can create and save light scenes which may be programmed to change automatically at specified times, as the fixtures move and re-focus the light without the use of ladders or scaffolds.

Moto-Zero

66 | 100 | 130 | Zoom 66



Body

Motorized track mounted spotlight with light head and control gear box in cast aluminium. Moto-Zero is available in 3 different light head diameters: 66mm, 100mm and 130mm. The fixtures are inclusive of adapter compatible with 3 phase eurotype track.

The control gearbox is available in two different shapes, D and S. Check page 93 for more details about gearboxes. Two DC motors drive the movements of the fixture, tilting them vertically up to 90° in two directions and rotating them horizontally 350°. Moto-Zero 66 Zoom: a third motor controls a special lens, which allows the user to shape the light beam from narrow to wide diffuse.

The movements and the beam shaping of the fixture, as well as the intensity and the colour tuning of the light, are controlled via CASAMBI™ application.

Accessories

Linear spread, honeycomb louvre, Visor, Snoot.

For more information about accessories see page 82 and for track accessories see page 92-93.

Finish

Powder coat in black or white colour.

LED sources

COB LED. High Power LED. Lumenetix Full Spectrum. Tuneable White. RGBW (130).

CRI: 90 | CCT: 3000K, 4000K, Full Spectrum, Tuneable White.

Other CRI and CCT options available on request.

Optic

Lens or Reflector (according with the chosen model/light source).

Super narrow (7°), narrow, medium and wide beam angle available.

Driver

Dimmable driver integrated in the gear box.

Motion Control: Casambi, LaserDim.

Dimming Options: Casambi, LaserDim, 0-10V, DALI, DMX.

Colour Tuning: Casambi, DMX.

Applications

A stylish motorized spotlight created for the purpose to meet the highest requirements of the most advanced lighting technology.

Application areas: retail, museums, hospitality, offices.

Moto - Zero 66 / 100

Moto - Zero Zoom 66

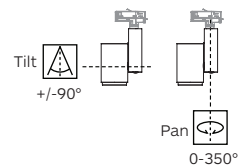

Moto - Zero 130

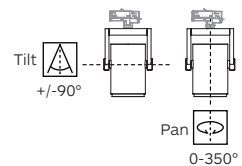

Moto-Zero 66 & Moto-Zero Zoom 66



Moto-Zero 66

Main Voltage Track



Moto-Zero Zoom 66

Main Voltage Track



Gear Box Type D (D)

Gear Box Type S (S)

Gear Box Type D (D)

Gear Box Type S (S)

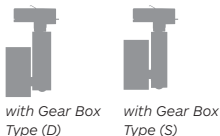
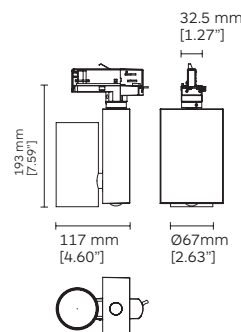
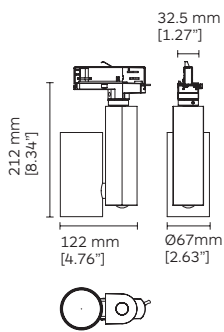
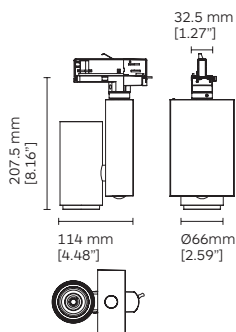
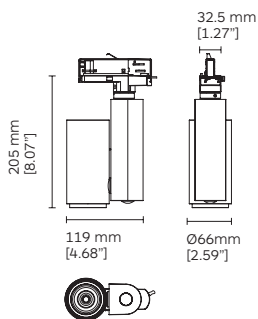

Code ordering example: **M 6 2 1 | I C 3 2 - 9 0 3 0 1 5 | D L 1 0**

	Product code	Light source code*	>CRI	CCT**	LED Power	Nominal Lumen	Beam angle (BA°)	Driver & Box Type Options	Finish
Moto - Zero 66	M621	IC32 COB LED	90	30 3000K	26W	2450 lm	15 / 23 / 45	DL Laser Dim	10 ■ Black
		BR21 High Power LED		40 4000K	6W	530 lm	05	DC CASAMBI	11 □ White
		BL22 Lumenetix ¹		FS Full Spectrum	18W	750 lm	18 / 25 / 33	SA DALI Dim	
		IU21 TW COB LED		TW 2700-6500K	13W	1290 lm	16 / 25 / 48	D1 0 - 10 Dim	
								SX DMX	
Moto - Zero Zoom 66	M641	BC31 COB LED	90	30 3000K	14W	1410 lm	BS (10° - 30°) ²	DC CASAMBI	
			40 4000K			1540 lm		SA DALI Dim	
								D1 0 - 10 Dim	
								SX DMX	

Notes:

* For complete code ordering information, please see page 97.

For related accessories, please see page 82-83.

** For other CCT options, Tuneable White (TW) version please contact us. For Tuneable White (TW) option, the type of driver box is always Square shape (S).

BS: Beam shaping. ²Wide angle donotes as field angles.

¹ Tuning range: 1650-8000K. Gradients of saturated colours from 1-100% can be added to colour points within the tuning range.

² The values in the nominal lumen are referring to the peak lumen.

Pan/tilt/zoom control by Casambi app. Dim options: Casambi app or 0-10V / DALI / DMX by main control system .

Moto-Zero 100 & Moto-Zero 130



Moto-Zero 100

Main Voltage Track



Moto-Zero 130

Main Voltage Track



Gear Box Type D (D)

Gear Box Type S (S)

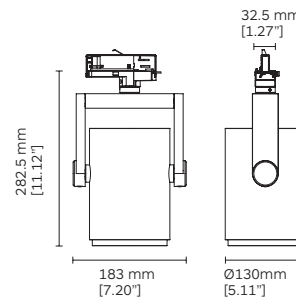
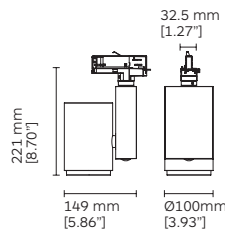
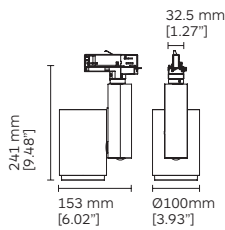





with Gear Box
Type (D)



with Gear Box
Type (S)

Code ordering example: **M 6 2 0 | I C 3 3 - 9 0 3 0 1 2 | D C 1 0**

	Product code	Light source code*	>CRI	CCT**	LED Power	Nominal Lumen	Beam angle (BA°)	Driver & Box Type Options	Finish		
								 			
Moto - Zero 100	M620	IC33 COB LED	90	30 3000K	33W	3290 lm	12 / 27 / 55	DC	CASAMBI	10  Black	
				40 4000K					SA DALI Dim	11  White	
	BR21 High Power LED				21W	1862 lm	07 / 24 / 36	D1	0 - 10 Dim		
							1920 lm		SX DMX		
		BL23 Lumenetix ¹	FS Full Spectrum		25W	950 lm	12 / 19 / 28	DC	SC CASAMBI		
Moto - Zero 130	M619	IC34 COB LED	90	30 3000K	43W	4480 lm	10 / 18 / 42	DL	Laser Dim		
				40 4000K					DC	CASAMBI	
	BR21 High Power LED				29W	2780 lm	07 / 24 / 36	DA	Dali Dim		
							2910 lm		D1	0-10 Dim	
		BE31 RGBW	RG BW		34W	2320 lm	12 / 24 / 36	DX	DMX		
	BL35 Lumenetix ¹	FS Full Spectrum			50W	2600 lm	26 / 31 / 36	DC	CASAMBI		
BU81 TW High Power LED			TW 2700-6500K		33W	3260 lm	20 / 30 / 40				

Notes:

* For complete code ordering information, please see page 97.

For related accessories, please see page 82-83.

** For other CCT options, please contact us.

¹ Tuning range: 1650-8000K. Gradients of saturated colours from 1-100% can be added to colour points within the tuning range.

¹ The values in the nominal lumen are referring to the peak lumen.



*Product Name: Moto-Zero
Location of Project: Opera Gallery, Hong Kong*

Moto-Ola



Body

Motorized track mounted spotlight with light head and control gear box in cast aluminium. Moto-Ola is available in 2 light head diameters: 100mm and 130mm. The fixtures are inclusive of adapter compatible with 3 phase eurotype track.

The control gearbox is available in two different shapes, D and S, too fit different type of drivers. Check page 93 for more details about the dimensions and the details of the control gearboxes.

Two DC motors drive the movements of the fixture, tilting them vertically up to 90° in two directions and rotating them horizontally 350°. The movements of the fixture, as well as the intensity and the colour tuning of the light, are controlled via CASAMBI™ application.

Accessories

For more information about track accessories see page 92-93.

Finish

Powder coat in black and white colour.

LED sources

COB LED. High Power LED. Lumenetix Full Spectrum.
CRI: 90, 95 (100) | CCT: 3000K, 4000K, Full Spectrum.
Other CRI and CCT options available on request.

Optic

Lens.
Narrow, medium and wide beam angle available.
Moto-Ola 130 available in wallwasher version.

Driver

Dimmable driver integrated in the gear box.
Motion Control: Casambi, LaserDim.
Dimming Options: Casambi, LaserDim, 0-10V, DALI, DMX.
Colour Tuning: Casambi, DMX.

Applications

A chic and alluring light fixture, created by formalighting's passionate designers. The MOTOLUX technology permit to promptly adapt the light to any scene change.
Application areas: museums, hotels, restaurants, retail.

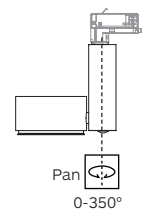
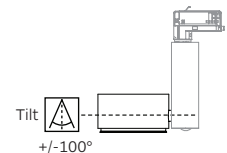

Moto-Ola





Moto-Ola 100 BC33 **Moto-Ola 130** BC33 **Moto-Ola 130** BR21

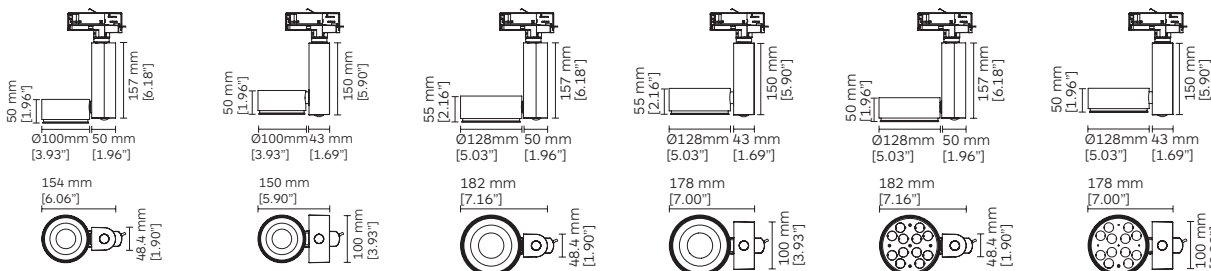

Gear Box Type D (D) **Gear Box Type S (S)** **Gear Box Type D (D)** **Gear Box Type S (S)** **Gear Box Type D (D)** **Gear Box Type S (S)**



Code ordering example: **M 6 3 7 B C 3 3 - 9 0 3 0 1 5 D L 1 0**

Product code	Light source code*	>CRI	CCT**	LED Power	Nominal Lumen	Beam angle (BA°)	Driver & Box Type Options		Finish
							 D	 S	
Moto - Ola 100	BC33 COB LED	90	30 3000K	17W	1934 lm	15 / 24 / 37	DL	Laser Dim	10  Black
			40 4000K		2041 lm	DC	CASAMBI	11  White	
	BR21 High Power LED	90	30 3000K	21W	1862 lm	07 / 24 / 36	SA	DALI Dim	
			40 4000K		1920 lm	D1	0 - 10 Dim	SX	DMX
Moto - Ola 130	BC33 COB LED	90	30 3000K	25W	2760 lm	12 / 22 / 32	DL	Laser Dim	
			40 4000K		3000 lm	DC	CASAMBI		
Moto - Ola 130	BR21 High Power LED	90	30 3000K	29W	2780 lm	07 / 24 / 36	SA	DALI Dim	
			40 4000K		2910 lm	D1	0 - 10 Dim	SX	DMX
	BR11 High Power LED	90	30 3000K	24W	2550 lm	10 / 23 / 46 / WW	SX	DMX	
			40 4000K		2730 lm	DC	CASAMBI	DX	DMX
Moto - Ola 130	BL23 Lumenetix ¹	90	FS Full Spectrum	25W	950 im	11 / 19 / 28	DC	CASAMBI	
						DX	DMX		

Notes:

* For complete code ordering information, please see page 97.
 ** For other CCT options, Tuneable White (TW)  version please contact us. For Tuneable White (TW) option, the type of driver box is always Square shape (S).
¹ Tuning range: 1650-8000K. Gradients of saturated colours from 1-100% can be added to colour points within the tuning range.
¹ The values in the nominal lumen are referring to the peak lumen.

WW: Wallwasher
 PATENTED

Moto-Polaris

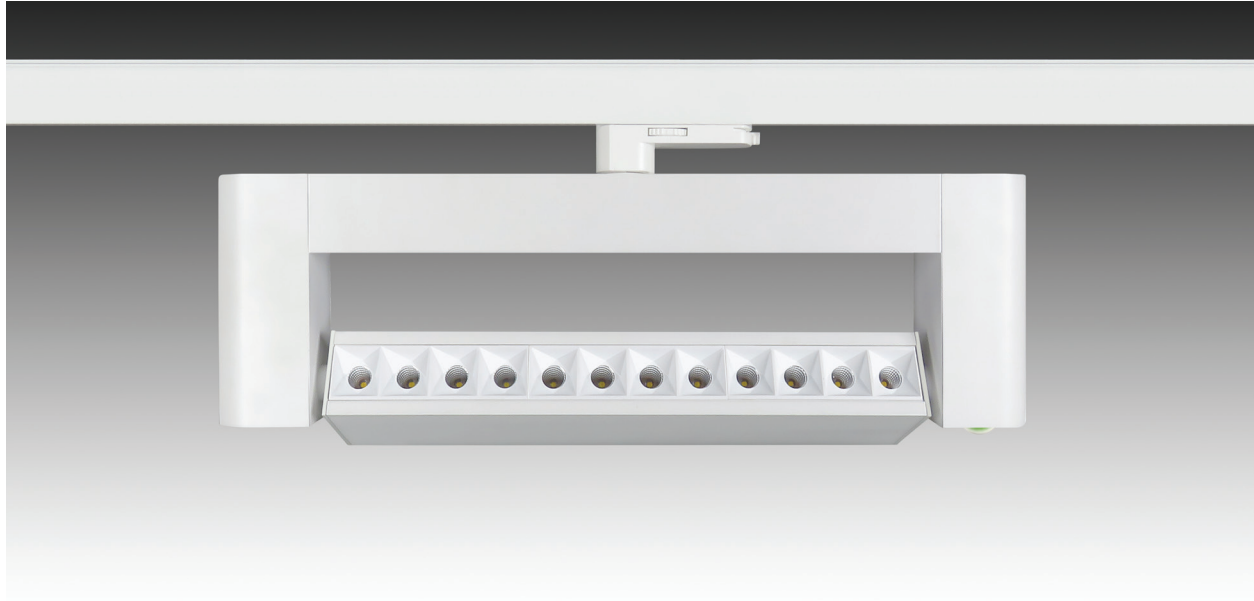

Body

Motorized track mounted spotlight with light body and light heads housing in cast aluminium. Light heads inclusive of integrated diamond faceted no-dazzle screen in thermoplastic to meet greater visual comfort and high light efficiency.

Moto-Polaris is available in 2 two different configuration with 8 or 12 light heads. The fixtures are inclusive of adapter compatible with 3 phase eurotype track. Two DC motors drive the movements of the fixtures, tilting them vertically up to 100° in two directions and rotating them horizontally 350°.

The movements of the fixture, as well as the intensity and the colour tuning of the light, are controlled via CASAMBI™ application

Accessories

For more information about track accessories see page 92-93.

Finish

Powder coat in black and white colour.

LED sources

High Power LED. CRI: 90 | CCT: 3000K, 4000K. Other CRI and CCT options available on request.

Optic

Reflector.

Medium and wide beam angle available.

Driver

Integrated dimmable driver.

Motion Control: Casambi, LaserDim.

Dimming Options: Casambi, LaserDim, 0-10V, DALI, DMX.

Applications

An innovative solution for high brilliance and performance. The MOTOLUX technology allow to oriented the light where is needed.

Application areas: museums, conference rooms, hotels, restaurants, retail.

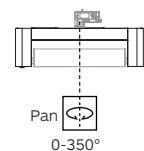
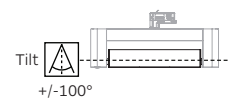

Moto-Polaris



Moto - Polaris

Main Voltage Track with 8 LEDs

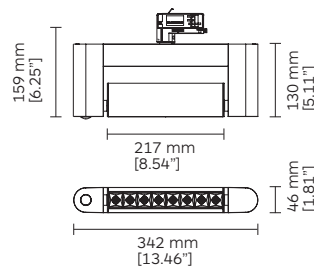
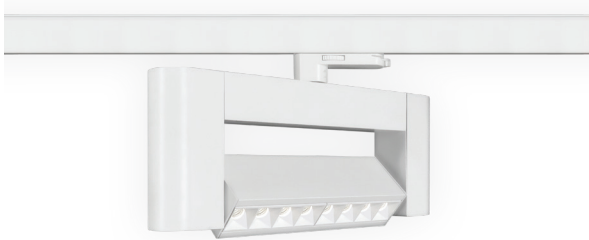

Moto - Polaris

Main Voltage Track with 12 LEDs

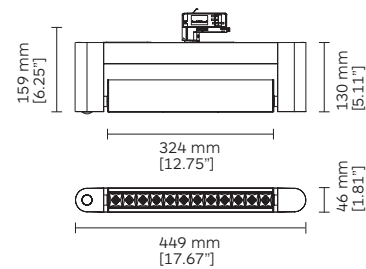
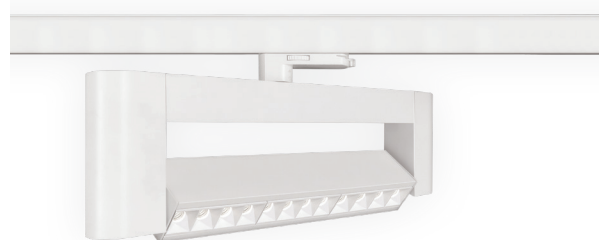

Code ordering example: **M618BO11-903034DL10**

	Product code	Light source code*	>CRI	CCT**	LED Power	Normal Lumen	Beam angle (BA°)	Driver Options	Finish
Moto-Polaris with 8 LEDs	M618	BO11 High Power LED	90	30 3000K	8x2W	1520 lm	34 / 50	DL Laser-Dim	10 ■ Black
				40 4000K		1920 lm		DC CASAMBI	11 □ White
Moto-Polaris with 12 LEDs	M617				12x2W	2280 lm		DS Scene by CASAMBI	
						2880 lm			

Notes:

* For complete code ordering information, please see page 97.

** For other CCT options, Tuneable White (TW)  version please contact us.

Moto-Combo & Moto-Combo Zoom



Body

Motorized round recessed luminaire with mounting trim and light head made of cast aluminium. Fixture body made of aluminium and mounting ring of mild steel. Brackets for trim installation on ceiling thickness max. 25 mm.

Two DC motors drive the movements of the fixture, which is tiltable vertically 40° in all directions on a dual axis gimbal. A third motor controls a special lens, which allows the user to shape the light beam range between 7°-18°.

The movements and the beam shaping of the fixture, as well as the intensity and the colour tuning of the light, are controlled via LaserDim™ remote control or CASAMBI™ application.

Accessories

Honeycomb louvre.
For more information about accessories see page 83.

Finish

Powder coat in black, white and grey colour.

LED sources

COB LED, High Power LED, Lumenetix Full Spectrum.
Zoom COB LED.
CRI: 90 | CCT: 3000K, 4000K, FS.
Other CRI and CCT options, Tuneable White and DimToWarm versions available on request

Optic

Lens.
Narrow, medium and wide beam angle available.
Zoom version available with a 7°-18° range.

Driver

Supplied with remote dimmable driver.
Motion Control: Casambi, LaserDim.
Dimming Options: Casambi, LaserDim, 0-10V, DALI, DMX.
Colour Tuning: Casambi, DMX.

Applications

Ideal solution for festive and celebration events. Downlight designed with a concealed lamp setting offering visual comfort. The Zoom option makes Moto-Combo perfect for ambience, which need frequent reconfiguration.
Application areas: banquet halls, ballrooms, restaurants.

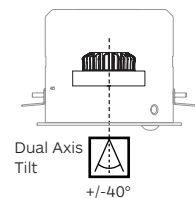

Moto-Combo & Moto-Combo Zoom



Moto-Combo & Moto-Combo Zoom

Trim

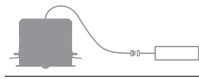
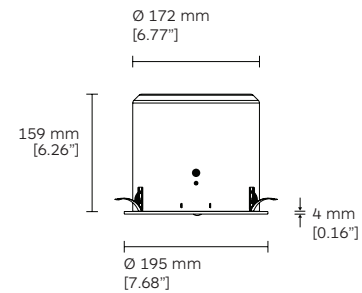
Ø186
Code ordering example: M 5 3 3 A C 3 3 - 9 0 3 0 1 5 D L 1 0

	Product code	Light source code*	>CRI	CCT**	LED Power	Norminal Lumen	Beam angle (BA°)	Driver Options	Finish
Moto-Combo	M533	AC33 COB LED	90	30 3000K	21W	2280 lm	15 / 24 / 38	DL Laser-Dim	10 Black
				40 4000K		2490 lm		DC CASAMBI	11 White
	MR21 High Power LED	26W	2630 lm	07 / 24 / 36	DA Dali Dim	75 Grey			
		2750 lm			D1 0-10 Dim				
	ML22 Lumenetix ¹	90	FS Full Spectrum	18W	950 lm	11 / 19 / 28	DC CASAMBI		
							DX DMX		
Moto-Combo Zoom	M590	MN21 COB LED	90	30 3000K	17W	1827 lm	BS (07° - 18°)	DC CASAMBI	
				40 4000K		1955 lm			

Notes:

* For complete code ordering information, please see page 97.

For related accessories, please see page 82-83.

** For other CCT options, Tuneable White (**TW**) version please contact us.

¹ Tuning range: 1650-8000K. Gradients of saturated colours from 1-100% can be added to colour points within the tuning range.

¹ The values in the nominal lumen are referring to the peak lumen.

PATENTED

BS: Beam shaping.

Moto-Venus

Recessed Round & Square 70 | 125

Venus Concave



Venus



Body

Motorized round/square recessed luminaire with mounting trim and light body made of cast aluminium. Body aesthetic available in Flat or Concave design. The luminaire includes brackets for trim installation on ceiling thickness max. 32mm, or trimless installation (only Venus 125) on ceiling thickness max. 25mm.

Two remote controlled DC motors drive the movements of the fixture. Moto-Venus 70 is tiltable vertically 0-30° in two directions, Moto-Venus 125 is tiltable vertically 0-45° in two directions. All the fixtures are rotatable horizontally 350°.

The movements of the fixture, as well as the intensity and the colour tuning of the light, are controlled via CASAMBI™ application.

Accessories

No accessories available

Finish

Powder coat in black or white colour.

LED sources

COB LED.
CRI: 90 | CCT: 3000K, 4000K.
Other CRI and CCT options available on request.

Optic

Reflector + diffuser.
Narrow, medium and wide beam angle available.

Driver

Supplied with remote dimmable driver.
Motion Control: Casambi.
Dimming Options: Casambi, 0-10V, DALI.

Applications

The smallest motorized recessed luminaire in the market. The MOTOLUX technology add the versatility to adapt the direction and intensity of light to any type of environment. Application areas: hotels, residential, lobbies, offices, restaurants.

Moto - Venus 70

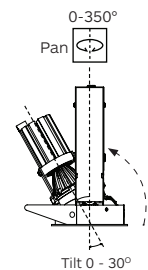

Moto - Venus 125

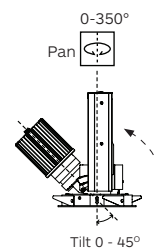

Moto-Venus Concave



Moto-Venus Concave 70

Round Trim



Ø67

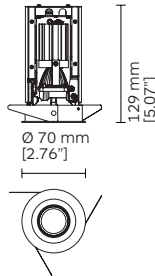

Moto-Venus Concave 125

Round Trim



Ø134

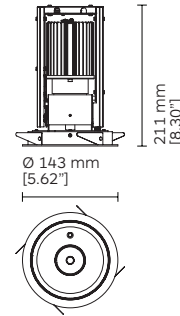

Moto-Venus Concave 125

Round Trimless



Ø134

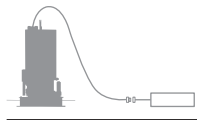
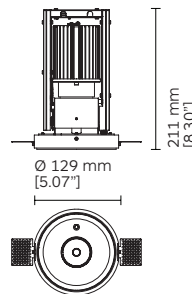

Code ordering example: **M 5 5 8 M C 3 1 - 9 0 3 0 1 8 D C 1 0**

	Product Code	Ingress Protection	Light Source Code*	>CRI	CCT**	LED Power	Nominal Lumen	Beam Angle (BA°)	Driver Options	Finish
Moto-Venus Concave 70 Round	M558	IP20	MC31 COB LED	90	30 3000K	6W	616 lm	18 / 24 / 32	DC CASAMBI	10 Black
					40 4000K			DA Dali Dim	11 White	
Moto-Venus Concave 125 Round	M555 M573		MC22 COB LED			22W	2418 lm	20 / 30	D1 0-10V Dim	
							2456 lm		DX DMX	

Notes:

* For complete code ordering information, please see page 97.

** For other CCT options, Tuneable White (TW) version please contact us.

Moto-Venus



Moto-Venus 70
Round Trim

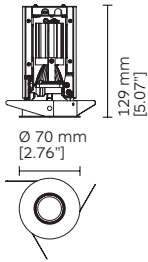

Moto-Venus 125
Round Trim

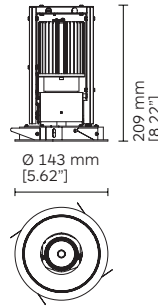

Moto-Venus 125
Round Trimless

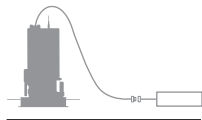
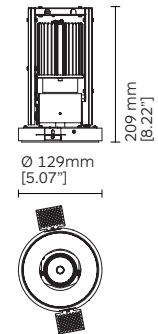

Code ordering example: **M 5 6 0 M C 3 1 - 9 0 3 0 1 8 D C 1 0**

	Product Code	Ingress Protection	Light Source Code*	>CRI	CCT**	LED Power	Nominal Lumen	Beam Angle (BA°)	Driver Options	Finish
Moto-Venus 70 Round	M560	IP20	MC31 COB LED	90	30 3000K	6W	616 lm	18 / 24 / 32	DC CASAMBI	10 Black
					40 4000K		643 lm		DA Dali Dim	11 White
Moto-Venus 125 Round	M556		MC22 COB LED			22W	2418 lm	20 / 30	D1 0-10V Dim	
	M572						2456 lm		DX DMX	

Notes:

* For complete code ordering information, please see page 97.

** For other CCT options, Tuneable White (TW) version please contact us.

Moto-Venus Concave



Moto-Venus Concave 70

Square Trim



Moto-Venus Concave 125

Square Trim

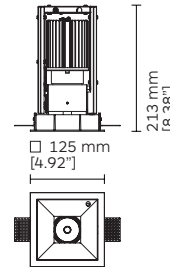
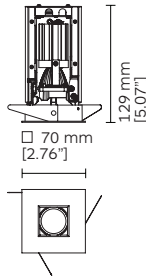

Moto-Venus Concave 125

Square Trimless

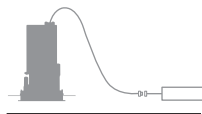
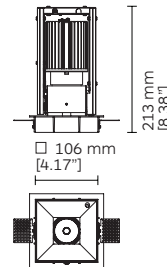

Code ordering example: **M 5 5 9 M C 3 1 - 9 0 3 0 1 8 D C 1 0**

	Product Code	Ingress Protection	Light Source Code*	>CRI	CCT**	LED Power	Nominal Lumen	Beam Angle (BA°)	Driver Options	Finish
Moto-Venus Concave 70 Square	M559 <input type="checkbox"/>	IP20	MC31 COB LED	90	30 3000K	6W	616 lm	18 / 24 / 32	DC CASAMBI	10 <input type="checkbox"/> Black
					40 4000K			DA Dali Dim	11 <input type="checkbox"/> White	
Moto-Venus Concave 125 Square	M554 <input type="checkbox"/> M575 <input type="checkbox"/>		MC22 COB LED			22W	2418 lm	20 / 30	D1 0-10V Dim	
							2456 lm		DX DMX	

Notes:

* For complete code ordering information, please see page 97.

** For other CCT options, Tuneable White (TW) version please contact us.

Moto-Venus



Moto-Venus 70

Square Trim



67

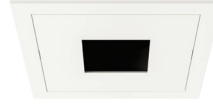

Moto-Venus 125

Square Trim



114

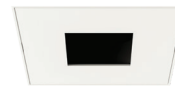
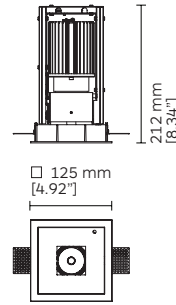
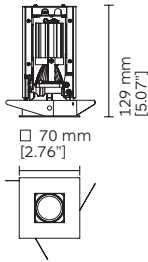

Moto-Venus 125

Square Trimless



114

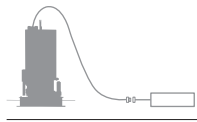
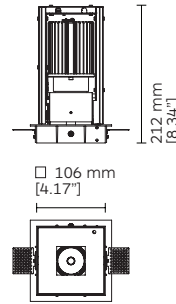

Code ordering example: **M 5 5 9 M C 3 1 - 9 0 3 0 1 8 D C 1 0**

	Product Code	Ingress Protection	Light Source Code*	>CRI	CCT**	LED Power	Nominal Lumen	Beam Angle (BA°)	Driver Options	Finish
Moto-Venus 70 Square	M561 <input checked="" type="checkbox"/>	IP20	MC31 COB LED	90	30 3000K	6W	616 lm	18 / 24 / 32	DC CASAMBI	10 <input checked="" type="checkbox"/> Black
					40 4000K			DA Dali Dim	11 <input type="checkbox"/> White	
Moto-Venus 125 Square	M557 <input checked="" type="checkbox"/> M574 <input type="checkbox"/>		MC22 COB LED			22W	2418 lm	20 / 30	D1 0-10V Dim	
							2456 lm		DX DMX	

Notes:

* For complete code ordering information, please see page 97.

** For other CCT options, Tuneable White (TW) version please contact us.



Product Name: Moto-Venus Roma
Location of Project: MGM, Macao

Moto-Zero In & Out

Recessed 40 | 66



Body

Fully adjustable round recessed motorized luminaire with retractable light head. Mounting trim and light head are made of cast aluminium, recessed light housing made of painted metal. Moto-Zero In&Out is available in 2 different light head diameters: 40mm and 66mm.

The luminaire includes springs for trim installation on ceiling thickness 1-25mm. Three remote controlled DC motors drive the movements of the fixtures. The fixtures are rotatable horizontally 350° and, after full extraction of the light head, tiltable vertically up to 90°.

The movements of the fixture, as well as the intensity and the colour tuning of the light, are controlled via CASAMBI™ application.

Accessories

For 66 Version: linear spread, honeycomb louvre.
For more information about accessories see page 83.

Finish

Powder coat in black or white colour.

LED sources

COB LED, High Power LED, Lumenetix Full Spectrum (66), Zoom COB LED.
CRI: 90 | CCT: 3000K, 4000K, FS.
Other CRI and CCT options, Tuneable White and DimToWarm versions available on request

Optic

Lens.
Super narrow, narrow, medium and wide beam angle available.

Driver

Supplied with remote dimmable driver.
Motion Control: Casambi.
Dimming Options: Casambi, 0-10V, DALI, DMX.
Colour Tuning: Casambi, DMX.

Applications

Its unique pull-down mechanism, enables it to function as either a downlight or a exposed lamp able to emulate a surface or track fixture.
Application areas: retail, hotels, museums, window displays.

Moto - Zero Compasso
40 / 66

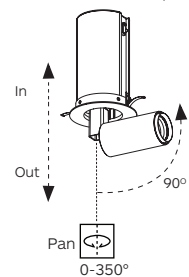

Moto-Zero In & Out

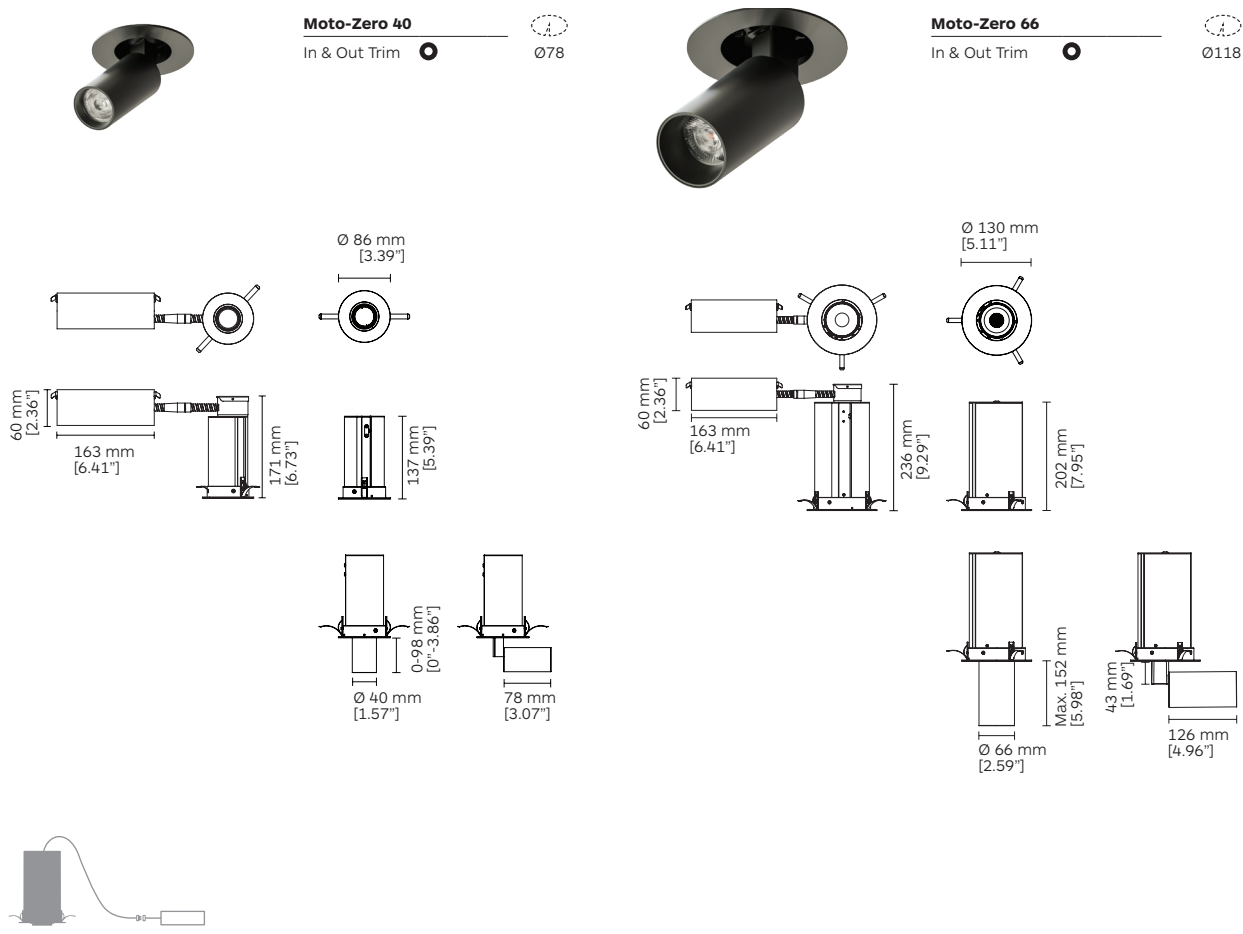

Code ordering example: **M 5 6 2 B C 3 1 - 9 0 3 0 1 6 D C 1 0**

	Product Code	Light Source Code*	>CRI	CCT**	LED Power	Nominal Lumen	Beam Angle (BA°)	Driver Options	Finish
Moto-Zero 40 In & Out	M562	BC31 COB LED	90	30 3000K	6W	664 lm	16 / 26 / 36	DC CASAMBI	10 Black
			40 4000K		722 lm		DA Dali Dim	11 White	
		BR21 High Power LED	90		4W	400 lm	07 / 24 / 36	D1 0-10V Dim	
							DX DMX		
Moto-Zero 66 In & Out	M563	BC22 COB LED	90	30 3000K	12W	1550 lm	16 / 25 / 36		
			40 4000K		1570 lm				
		BR21 High Power LED	90		6W	532 lm	05		
	BL22 Lumenetix ¹		FS Full Spectrum	18W	750 lm	18 / 25 / 34	DC CASAMBI		
							DX DMX		

Notes:

* For complete code ordering information, please see page 97.

For related accessories, please see page 82-83.

** For other CCT options, Tuneable White (TW) version please contact us.

¹ Tuning range: 1650-8000K. Gradients of saturated colours from 1-100% can be added to colour points within the tuning range.

² The values in the nominal lumen are referring to the peak lumen.

PATENT Pending

Moto-Palla In & Out

Recessed Round & Square 70 | 100 | 130



Body

Round/square recessed motorized luminaire with retractable light head. Mounting trim and light head are made of cast aluminium, recessed light housing made of painted metal. Moto-Palla In&Out is available in 3 different light head diameters: 66mm, 100mm and 130mm.

The luminaire includes brackets for trim installation on ceiling thickness max. 25 mm or trimless installation on ceiling thickness max. 30 mm. Two remote controlled DC motors drive the movements of the fixtures. The fixtures are rotatable horizontally 350° and, tiltable vertically in two directions (0°-10° In, 0°-90° Out).

The movements of the fixture, as well as the intensity and the colour tuning of the light, are controlled via CASAMBI™ application.

Accessories

Honeycomb louvre.
For more information about accessories see page 83.

Finish

Powder coat in black or white colour.

LED sources

COB LED, High Power LED (130), Lumenetix Full Spectrum (100, 130).
CRI: 90 | CCT: 3000K, 4000K, FS.
Other CRI and CCT options, Tuneable White and DimToWarm versions available on request

Optic

Lens.
Narrow, medium and wide beam angle available.

Driver

Supplied with remote dimmable driver.
Motion Control: Casambi, LaserDim.
Dimming Options: Casambi, LaserDim, 0-10V, DALI, DMX.
Colour Tuning: Casambi, DMX.

Applications

Its pull down mechanism powered by MOTOLUX technology, enables it to function either as a downlight, a recessed accent light, or a exposed lamp able to emulate a track fixture.

Application areas: retail, hotels, restaurants, offices.

Moto - Palla In & Out Round

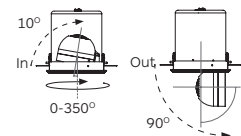

Moto - Palla In & Out Square

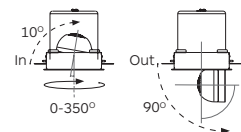

Moto-Palla In & Out



Moto-Palla 70
In & Out Round Trim Ø120

Moto-Palla 100
In & Out Round Trim Ø150

Moto-Palla 130
In & Out Round Trim Ø180



Moto-Palla 70
In & Out Round Trimless Ø120

Moto-Palla 100
In & Out Round Trimless Ø162

Moto-Palla 130
In & Out Round Trimless Ø192

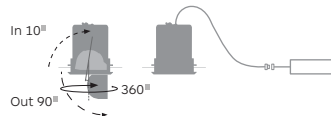
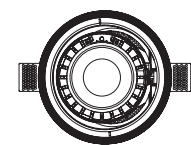
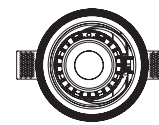
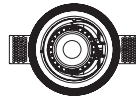
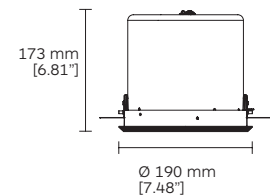
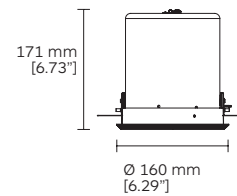
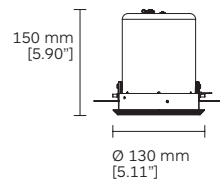

Code ordering example: **M 5 4 8 B C 2 2 - 9 0 3 0 1 6 D L 1 0**

	Product Code	Light Source Code*	>CRI	CCT**	LED Power	Nominal Lumen	Beam Angle (BA*)	Driver Options	Finish
Moto -Palla 70 In & Out Round	M548 <input checked="" type="radio"/>	BC22 COB LED	90	30 3000K	12W	1500 lm	16 / 25 / 36	DL Laser Dim	10 <input checked="" type="checkbox"/> Black
	M549 <input type="radio"/>			40 4000K		1550 lm		DC CASAMBI	11 <input type="checkbox"/> White
Moto - Palla 100 In & Out Round	M550 <input checked="" type="radio"/>	BC33 COB LED			21W	2200 lm	15 / 24 / 38	DA DALI	
	M551 <input type="radio"/>					2300 lm		D1 0-10V Dim	
		BL22 Lumenetix ¹		FS Full Spectrum	18W	750 lm	18 / 25 / 33	DC CASAMBI	DX DMX
Moto - Palla 130 In & Out Round	M552 <input checked="" type="radio"/>	BC33 COB LED	90	30 3000K	33W	3220 lm	12 / 22 / 32	DL Laser Dim	
	M553 <input type="radio"/>			40 4000K		3300 lm		DC CASAMBI	
		BR21 High Power LED			21W	1862 lm	07 / 24 / 36	DA DALI	D1 0-10V Dim
						1920 lm		DX DMX	
		BL23 Lumenetix ¹		FS Full Spectrum	25W	950 lm	12 / 19 / 28	DC CASAMBI	DX DMX

Notes:

* For complete code ordering information, please see page 97.

For related accessories, please see page 82-83.

** For other CCT options, Tuneable White (TW)  version please contact us.

¹ Tuning range: 1650-8000K. Gradients of saturated colours from 1-100% can be added to colour points within the tuning range.

¹ The values in the nominal lumen are referring to the peak lumen.

PATENT Pending

Moto-Palla In & Out



Moto-Palla 70
In & Out Square Trim □136

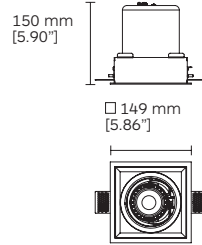

Moto-Palla 100
In & Out Square Trim □158

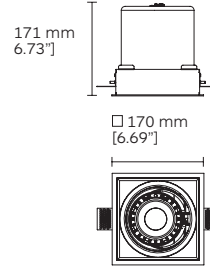

Moto-Palla 130
In & Out Square Trim □188

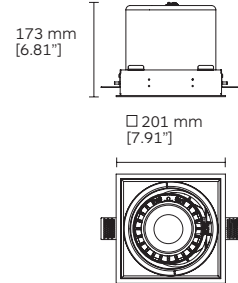

Moto-Palla 70
In & Out Square Trimless □136

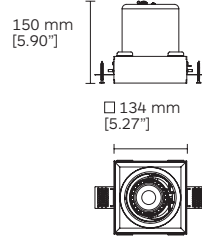

Moto-Palla 100
In & Out Square Trimless □158

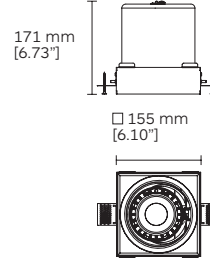

Moto-Palla 130
In & Out Square Trimless □188

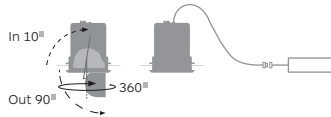
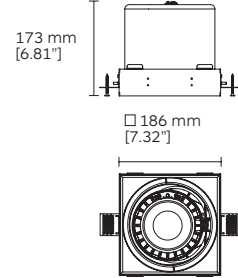

Code ordering example: **M 5 6 6 B C 2 2 - 9 0 3 0 1 6 D L 1 0**

	Product Code	Light Source Code*	>CRI	CCT**	LED Power	Nominal Lumen	Beam Angle (BA°)	Driver Options	Finish
Moto -Palla 70 In & Out Square	M566 <input checked="" type="checkbox"/>	BC22 COB LED	90	30 3000K	12W	1500 lm	16 / 25 / 36	DL Laser Dim	10 <input checked="" type="checkbox"/> Black
	M567 <input type="checkbox"/>			40 4000K		1550 lm		DC CASAMBI	11 <input type="checkbox"/> White
Moto - Palla 100 In & Out Square	M568 <input checked="" type="checkbox"/>	BC33 COB LED			21W	2200 lm	15 / 24 / 38	DA DALI	
	M569 <input type="checkbox"/>					2300 lm		D1 0-10V Dim	
								DX DMX	
		BL22 Lumenetix ¹		FS Full Spectrum	18W	750 lm	18 / 25 / 33	DC CASAMBI	
								DX DMX	
Moto - Palla 130 In & Out Square	M570 <input checked="" type="checkbox"/>	BC33 COB LED	90	30 3000K	33W	3220 lm	12 / 22 / 32	DL Laser Dim	
	M571 <input type="checkbox"/>			40 4000K		3300 lm		DC CASAMBI	
		BR21 High Power LED			21W	1862 lm	07 / 24 / 36	DA DALI	
						1920 lm		D1 0-10V Dim	
							DX DMX		
		BL23 Lumenetix ¹		FS Full Spectrum	25W	950 lm	12 / 19 / 28	DC CASAMBI	
								DX DMX	

Notes:

* For complete code ordering information, please see page 97.

PATENT Pending

For related accessories, please see page 82-83.

** For other CCT options, Tuneable White (TW)  version please contact us.

¹ Tuning range: 1650-8000K. Gradients of saturated colours from 1-100% can be added to colour points within the tuning range.

¹ The values in the nominal lumen are referring to the peak lumen.



Moto-Colosseo

90 | 120

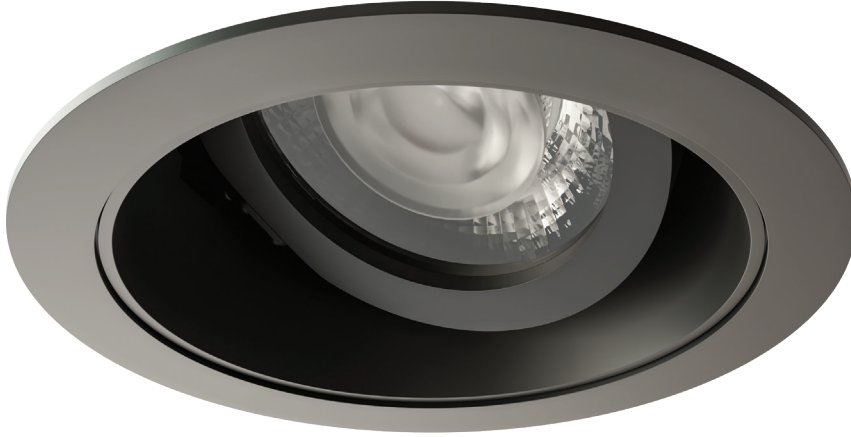

Body

Motorized fully adjustable round recessed luminaire. Mounting trim, light head and snoot are made of cast aluminium. Moto-Colosseo is available in 2 different light head diameters: 90mm and 120mm. The luminaire includes brackets for trim/trimless installation on ceiling thickness 6-15 mm.

Two remote controlled DC motors drive the movements of the fixture. The fixture are rotatable horizontally 350° and, tilttable vertically in two directions up to 30°.

The movements of the fixture, as well as the intensity and the colour tuning of the light, are controlled via CASAMBI™ application.

Accessories

Honeycomb louvre.
For more information about accessories see page 83.

Finish

Powder coat in black or white colour.

LED sources

COB LED.
CRI: 90 | CCT: 3000K, 4000K.
Other CRI and CCT options available on request.

Optic

Lens.
Narrow, medium and wide beam angle available.

Driver

Supplied with remote dimmable driver.
Motion Control: Casambi.
Dimming Options: Casambi, 0-10V, DALI, DMX.

Applications



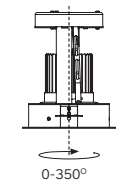
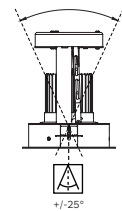

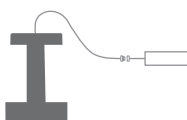
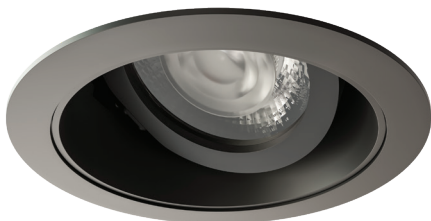
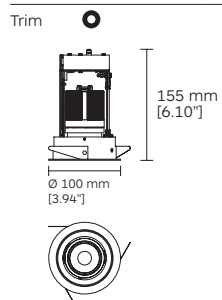
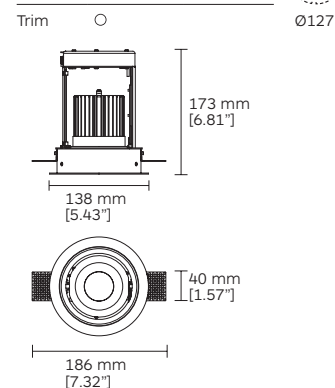
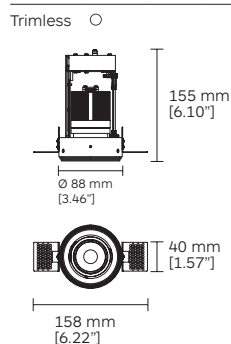
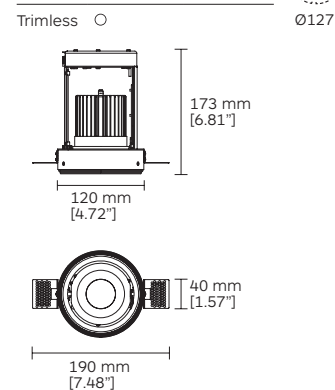

A smart evolution of the classic formalighting's Colosseo. Fully adjustable light designed to accommodate any retail application and allow lamp aiming while power is on. Application areas: retail, shopping centers, corridors, window display.



Moto-Colosseo

Moto-Colosseo 90

Moto-Colosseo 120

Moto-Colosseo 90

Moto-Colosseo 120

Code ordering example: **M 5 8 8 B C 3 1 - 9 0 3 0 1 1 D A 1 0**

	Product Code	Light Source Code*	>CRI	CCT**	LED Power	Nominal Lumen	Beam Angle (BA°)	Driver Options	Finish
Moto-Colosseo 90	M588 	BC31 COB LED	90	30 3000K	11W	1088 lm	11 / 24 / 32	DA Dali Dim	10  Black
	M578 			40 4000K		1183 lm		DP Phase Dim	11  White
Moto-Colosseo 120	M579 	BC32 COB LED			22W	2373 lm	12 / 18 / 32	DC CASAMBI	
	M589 					2637 lm		D1 0-10V Dim	
								DX DMX	

Notes:

* For complete code ordering information, please see page 97.
For related accessories, please see page 82-83.

** For other CCT options, Tuneable White (TW)  version please contact us.

Moto-Gimbalo

60 | 130 | Zoom 130



Body

Motorized Gimbal design recessed luminaire. Mounting trim and Gimbal head are made of cast aluminium. Moto-Gimbalo is available in 2 different sizes: 60mm and 130mm. The luminaire includes brackets for installation on ceiling thickness max. 25 mm.

Two remote controlled DC motors drive the movements of the fixture. Moto-Gimbalo 60: tiltable 0-40° in two directions and rotatable 350°; Moto-Gimbalo 130: Tiltable 0-40° in all directions on a dual axis gimbals. A third motor controls a special lens, which allows the user to shape the light beam of the Zoom version between 7°-18°.

The movements and the beam shaping of the fixture, as well as the intensity and the colour tuning of the light, are controlled via LaserDim™ remote control or CASAMBI™ app.

Accessories

Linear spread, honeycomb louvre, snoot, visor.
For more information about accessories see page 83.

Finish

Powder coat in black, white or grey colour.

LED sources

COB LED, High Power LED (130), Lumenetix Full Spectrum (130), Zoom COB (130).

CRI: 90 | CCT: 3000K, 4000K, FS.

Other CRI and CCT options, Tuneable White and DimToWarm versions available on request

Optic

Lens.

Narrow, medium and wide beam angle available. Zoom version available for Moto-Gimbalo 130 with a 7°-18° range.

Driver

Supplied with remote dimmable driver.

Motion Control: Casambi, LaserDim.

Dimming Options: Casambi, LaserDim, 0-10V, DALI, DMX.

Colour Tuning: Casambi, DMX.

Applications

A classic formalighting fixture with the best of MOTOLUX technology.

Applications areas: retail, hotels, restaurants, hospitals, lobbies, gyms.

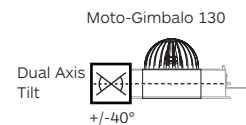
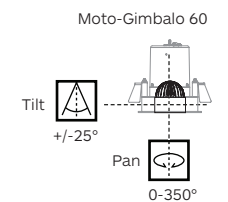

Moto-Gimbalo & Moto-Gimbalo Zoom

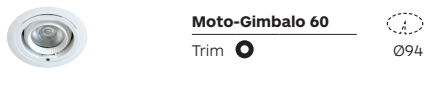

Moto-Gimbalo 60
Trim ● Ø94



Moto-Gimbalo 130
Trim ● Ø175



Moto-Gimbalo Zoom 130
Trim ● Ø175

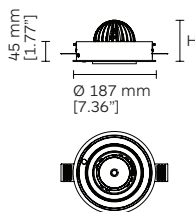
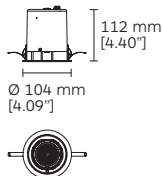

Light source code	Height (H) in mm
LC33	93
MR21	84
ML22	114

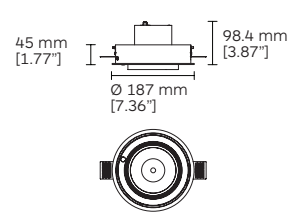

Moto-Gimbalo 60
Trimless ○ Ø100



Moto-Gimbalo 130
Trimless ○ Ø175



Moto-Gimbalo Zoom 130
Trimless ○ Ø175

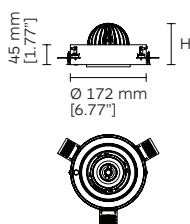
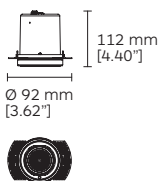

Light source code	Height (H) in mm
LC33	93
MR21	84
ML22	114

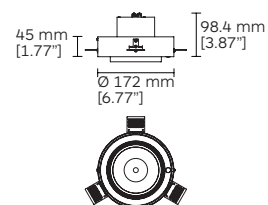

Code ordering example: **M 5 1 6 M C 2 2 - 9 0 3 0 1 8 D L 1 0**

	Product code	Light source code*	>CRI	CCT**	LED Power	Normal Lumen	Beam angle (BA°)	Driver Options	Finish
Moto - Gimbalo 60	M516 ●	MC22 COB LED	90	30 3000K	10W	1276 lm	18 / 24 / 36	DL Laser-Dim	10 ■ Black
	M517 ○		40 4000K			1296 lm		DC CASAMBI	11 □ White
		MR21 High Power LED			6W	532 lm	05	DA Dali Dim	75 ■ Grey
Moto - Gimbalo 130	M514 ●	LC33 COB LED			25W	2539 lm	12 / 27 / 55	D1 0-10 Dim	
	M515 ○					2761 lm		DX DMX	
		MR21 High Power LED			21W	1862 lm	07 / 21 / 36		
		ML22 Lumenetix ¹	FS Full Spectrum		18W	750 lm	12 / 19 / 28	DC CASAMBI	
Moto - Gimbalo Zoom 130	M580 ●	MN21 COB LED	90	30 3000K	17W	1827 lm	BS (07° - 18°)	DC CASAMBI	
	M581 ○		40 4000K			1955 lm			

Notes:

* For complete code ordering information, please see page 97.

BS: Beam shaping.

For related accessories, please see page 82-83.

** For other CCT options, Tuneable White (TW) version please contact us.

¹ Tuning range: 1650-8000K. Gradients of saturated colours from 1-100% can be added to colour points within the tuning range.

¹ The values in the nominal lumen are referring to the peak lumen.

PATENTED

Moto-MultiGimbalo

60 | 130 | Zoom 130



Body

Motorized Gimbal design recessed luminaire. Mounting trim and Gimbal head are made of cast aluminium. Moto-MultiGimbalo is available with up to 3 heads and in 2 different sizes: 60mm and 130mm. The luminaire includes brackets for installation on ceiling thickness max. 25 mm.

Two remote controlled DC motors drive the movements of the fixture. Moto-Gimbalo 60: tiltable 0-40° in two directions and rotatable 350°; Moto-Gimbalo 130: Tiltable 0-40° in all directions on a dual axis gimbals. A third motor controls a special lens, which allows the user to shape the light beam of the Zoom version between 7°-18°.

The movements and the beam shaping of the fixture, as well as the intensity and the colour tuning of the light, are controlled via LaserDim™ remote control or CASAMBI™ app.

Accessories

Linear spread, honeycomb louvre, snoot, visor.
For more information about accessories see page 83.

Finish

Powder coat in black, white and grey colour.

LED sources

COB LED, High Power LED (130), Lumenetix Full Spectrum (130), Zoom COB (130).

CRI: 90 | CCT: 3000K, 4000K, FS.

Other CRI and CCT options, Tuneable White and DimToWarm versions available on request

Optic

Lens.

Narrow, medium and wide beam angle available.

Zoom version available for Moto-Gimbalo 130 with a 7°-18° range.

Driver

Supplied with remote dimmable driver.

Motion Control: Casambi, LaserDim.

Dimming Options: Casambi, LaserDim, 0-10V, DALI, DMX.

Colour Tuning: Casambi, DMX.

Applications

Elegant luminaire features a fully adjustable double gimbal concept combined with an elegant design and the MOTOLUX technology.

Application areas: retail, corridors, window display, hotels, restaurants, lobbies.

Moto-MultiGimbalo 60

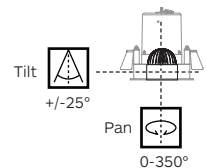

Moto-MultiGimbalo 130

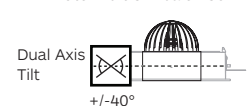

Moto-MultiGimbalo 60

Moto-MultiGimbalo 60

 1 Head Trim

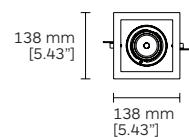
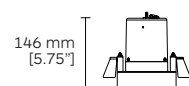
 129

Moto-MultiGimbalo 60

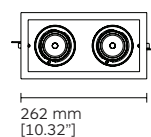
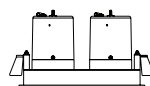
 2 Heads Trim

 129 x 249

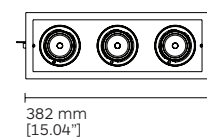
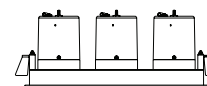
Moto-MultiGimbalo 60

 3 Heads Trim

 129 x 369

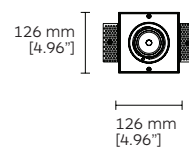
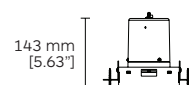
Moto-MultiGimbalo 60

 1 Head Trimless

 129

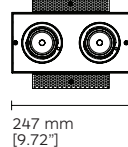
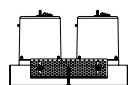
Moto-MultiGimbalo 60

 2 Heads Trimless

 129 x 249

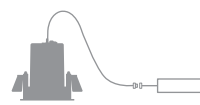
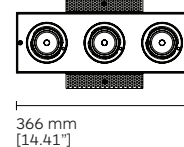
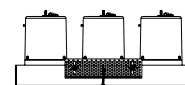
Moto-MultiGimbalo 60

 3 Heads Trimless

 129 x 369

 Code ordering example: **M 5 3 4 M C 2 2 - 9 0 3 0 1 8 D L 1 0**

	Product code	Light source code*	>CRI	CCT**	LED Power	Normal Lumen	Beam angle (BA°)	Driver Options	Finish	
Moto - MultiGimbalo 60 1 Head	M534 <input checked="" type="checkbox"/> x1	MC22 COB LED	90	30 3000K	10W	1276 lm	18 / 24 / 36	DL Laser-Dim	10 <input checked="" type="checkbox"/> Black	
	M536 <input type="checkbox"/>	MR21 High Power LED		40 4000K	6W	530 lm		05	DC CASAMBI	11 <input type="checkbox"/> White
					580 lm			D1 0-10 Dim	75 <input checked="" type="checkbox"/> Grey	
Moto - MultiGimbalo 60 2 Heads	M538 <input checked="" type="checkbox"/> x2	MC22 COB LED			2x10W	2552 lm	18 / 24 / 36	DX DMX		
	M540 <input type="checkbox"/>	MR21 High Power LED			2x6W	1060 lm			05	
					1160 lm					
Moto - MultiGimbalo 60 3 Heads	M542 <input checked="" type="checkbox"/> x3	MC22 COB LED			3x10W	3828 lm	18 / 24 / 36			
	M544 <input type="checkbox"/>	MR21 High Power LED			3x6W	1590 lm			05	
					1740 lm					

Notes:

* For complete code ordering information, please see page 97.

For related accessories, please see page 82-83.

** For other CCT options, Tuneable White (TW) version please contact us.

PATENTED

Moto-MultiGimbalo 130-1 & Moto-MultiGimbalo Zoom 130-1

Moto-MultiGimbalo 130

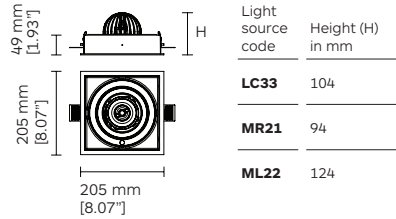
 1 Head Trim
191

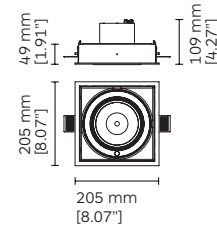
Moto-MultiGimbalo Zoom 130

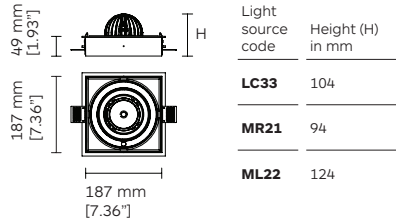
 1 Head Trim
191

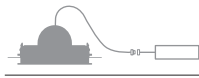
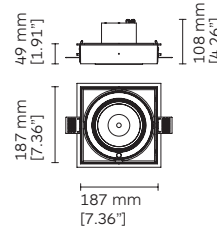
Moto-MultiGimbalo 130

 1 Head Trimless
191

Moto-MultiGimbalo Zoom 130

 1 Head Trimless
191

 Code ordering example: **M 5 0 1 L C 3 3 - 9 0 3 0 1 2 D L 1 0**

	Product code	Light source code*	>CRI	CCT**	LED Power	Norminal Lumen	Beam angle (BA°)	Driver Options	Finish
Moto - MultiGimbalo 130 1 Head	M501 <input checked="" type="checkbox"/> x1	LC33 COB LED	90	30 3000K	25W	2539 lm	12 / 27 / 55	DL Laser-Dim	10 <input checked="" type="checkbox"/> Black
	40 4000K					DC CASAMBI		11 <input type="checkbox"/> White	
	M502 <input type="checkbox"/>	MR21 High Power LED	95		21W	1862 lm	07 / 21 / 36	DA Dali Dim	75 <input checked="" type="checkbox"/> Grey
						1920 lm		D1 0-10 Dim	
		ML22 Lumenetix ¹	95	FS Full Spectrum	18W	750 lm	12 / 19 / 28	DC CASAMBI	DX DMX
Moto - MultiGimbalo Zoom 130 1 Head	M582 <input checked="" type="checkbox"/> x1	MN21 COB LED	90	30 3000K	17W	1827 lm	BS (07° - 18°)	DC CASAMBI	
	M583 <input type="checkbox"/>			40 4000K					1955 lm

Notes:

* For complete code ordering information, please see page 97.

BS: Beam shaping.

For related accessories, please see page 82-83.

 ** For other CCT options, Tuneable White (**TW**)  version please contact us.

¹ Tuning range: 1650-8000K. Gradients of saturated colours from 1-100% can be added to colour points within the tuning range.

¹ The values in the nominal lumen are referring to the peak lumen.

PATENTED

Moto-MultiGimbalo 130-2 & Moto-MultiGimbalo Zoom 130-2



Moto-MultiGimbalo 130

2 Heads Trim

374 x 191

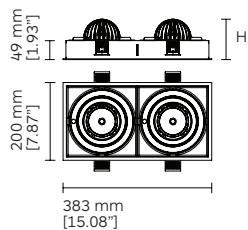

Light source code	Height (H) in mm
LC33	104
MR21	94
ML22	124

Moto-MultiGimbalo Zoom 130

2 Heads Trim

374x191

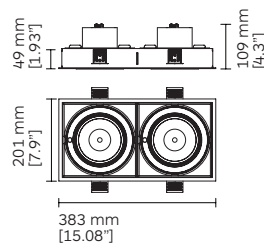

Moto-MultiGimbalo 130

2 Heads Trimless

374 x 191

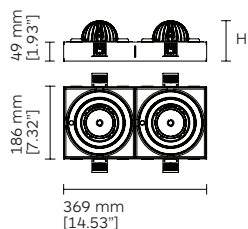

Light source code	Height (H) in mm
LC33	104
MR21	94
ML22	124

Moto-MultiGimbalo Zoom 130

2 Heads Trimless

374 x 191

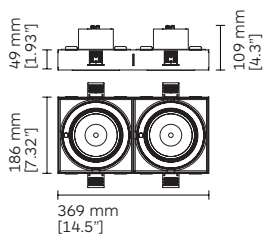

Code ordering example: **M 5 0 3 L C 3 3 - 9 0 3 0 1 2 D L 1 0**

	Product code	Light source code*	>CRI	CCT**	LED Power	Normal Lumen	Beam angle (BA°)	Driver Options	Finish
Moto - MultiGimbalo 130 2 Heads	M503 <input checked="" type="checkbox"/> x2	LC33 COB LED	90	30 3000K	2x25W	5078 lm	12 / 27 / 55	DL Laser-Dim	10 <input checked="" type="checkbox"/> Black
	M504 <input type="checkbox"/>			40 4000K		5522 lm		DC CASAMBI	11 <input type="checkbox"/> White
		MR21 High Power LED	95		2x21W	3724 lm	07 / 21 / 36	DA Dali Dim	75 <input checked="" type="checkbox"/> Grey
				ML22 Lumenetix ¹	FS Full Spectrum	2x18W		1500 lm	
							DX DMX		
Moto - MultiGimbalo Zoom 130 2 Heads	M584 <input checked="" type="checkbox"/> x2	MN21 COB LED	90	30 3000K	2x17W	3654 lm	BS (0° - 18°)	DC CASAMBI	
	M585 <input type="checkbox"/>			40 4000K		3910 lm			

Notes:

* For complete code ordering information, please see page 97.

BS: Beam shaping.

For related accessories, please see page 82-83.

** For other CCT options, Tuneable White (**TW**) version please contact us.

¹ Tuning range: 1650-8000K. Gradients of saturated colours from 1-100% can be added to colour points within the tuning range.

¹ The values in the nominal lumen are referring to the peak lumen.

PATENTED

Moto-MultiGimbalo 130-3 & Moto-MultiGimbalo Zoom 130-3

Moto-MultiGimbalo 130

 3 Heads Trim

557 x 191

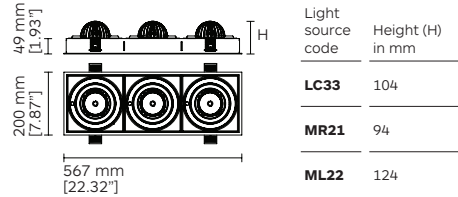
Moto-MultiGimbalo Zoom 130

 3 Heads Trim

557x191

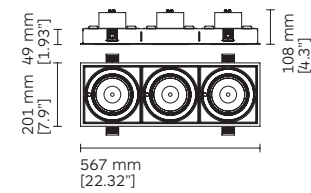
Moto-MultiGimbalo 130

 3 Heads Trimless

557 x 191

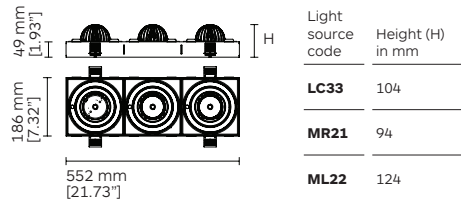
Moto-MultiGimbalo Zoom 130

 3 Heads Trimless

557 x 191

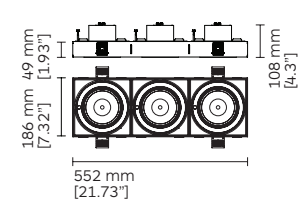
 Code ordering example: **M 5 0 5 L C 3 3 - 9 0 3 0 1 2 D L 1 0**

	Product code	Light source code*	>CRI	CCT**	LED Power	Normal Lumen	Beam angle (BA°)	Driver Options	Finish
Moto - MultiGimbalo 130 3 Heads	M505 <input checked="" type="checkbox"/> x3	LC33 COB LED	90	30 3000K	3x25W	7617 lm	12 / 27 / 55	DL Laser-Dim	10 <input checked="" type="checkbox"/> Black
	40 4000K				8283 lm	DC CASAMBI		11 <input type="checkbox"/> White	
	M506 <input type="checkbox"/>	MR21 High Power LED			3x21W	5586 lm 5760 lm	07 / 21 / 36	DA Dali Dim	75 <input checked="" type="checkbox"/> Grey
		ML22 Lumenetix ¹	95	FS Full Spectrum	3x18W	2250 lm	12 / 19 / 28	DC CASAMBI	DX DMX
Moto - MultiGimbalo Zoom 130 3 Heads	M586 <input checked="" type="checkbox"/> x3	MN21 COB LED	90	30 3000K	3x17W	5481 lm	BS (0° - 18°)	DC CASAMBI	
	M587 <input type="checkbox"/>			40 4000K		5865 lm			

Notes:

* For complete code ordering information, please see page 97.

BS: Beam shaping.

For related accessories, please see page 82-83.

 ** For other CCT options, Tuneable White (**TW**) version please contact us.

¹ Tuning range: 1650-8000K. Gradients of saturated colours from 1-100% can be added to colour points within the tuning range.

¹ The values in the nominal lumen are referring to the peak lumen.

PATENTED



Product Name: Moto-MultiGimbalo
Location of Project: Beijing

Moto-Flap

190 | 295



Body

Motorized wall mounted luminaire. Light Body and base are made of cast aluminium. The included wall fixing device is made of painted metal and is equipped with a catch retainer for luminaire easy installation.

Moto-Flap is available in 2 different sizes: 190mm and 295mm. Two remote controlled DC motors drive the movements of the fixture. A pan horizontal movement of 0-350° to create special light effect and a, like a shell, tilt vertical movement up to 90°.

The movements of the fixture, as well as the intensity and the colour tuning of the light, are controlled via CASAMBI™ application.

Accessories

No accessories available

Finish

Powder coat in black and white colour.

LED sources

COB LED, Lumenetix Full Spectrum (295).
CRI: 90 | CCT: 3000K, 4000K, FS.
Other CRI and CCT options, Tuneable White versions available on request.

Optic

Lens + diffuser.
Extra wide beam angle available.

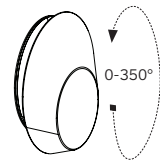
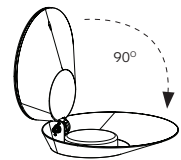

Driver

Supplied with integrated dimmable driver.
Motion Control: Casambi.
Dimming Options: Casambi, 0-10V, DALI, DMX.
Colour Tuning: Casambi, DMX.

Applications

The first decorative lamp from formalighting's award winning MOTOLUX range. Resembling a pearl oyster shell, Moto-Flap illuminates surrounding surfaces and emits a beam of luminous indirect light.
Application Areas: Hospitality, corridors, lounges.

Moto-Flap



Moto-Flap 190

Wall

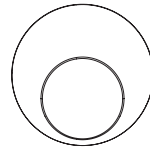

Ø 191 mm
[7.51"]



56 mm
[2.20"]

Moto-Flap 295

Wall

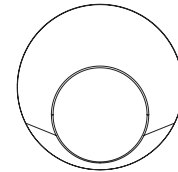

Ø 293 mm
[11.53"]

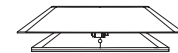

80 mm
[3.14"]



Code ordering example: **M106BC22-903000DC11**

	Product code	Light source code*	>CRI	CCT**	LED Power	Norminal Lumen	Beam angle (BA°)	Driver Options	Finish
Moto - Flap 190	M106	BC22 COB LED	90	30 3000K	8W	800 lm	00	DC CASAMBI	10 ■ Black
				40 4000K		840 lm			11 □ White
Moto - Flap 295	M105	BC22 COB LED			17W	1700 lm			
						1750 lm			
		BL22 Lumenetix ¹		FS Full Spectrum	18W	750 lm	18 / 25 / 33		

Notes:

* For complete code ordering information, please see page 97.

** For other CCT options, Tuneable White  version please contact us.

¹ Tuning range: 1650-8000K. Gradients of saturated colours from 1-100% can be added to colour points within the tuning range.

¹ The values in the nominal lumen are referring to the peak lumen.

Moto-Gimbalo Surface



Body

Motorized ceiling mounted downlight. Light head and body are made of cast aluminium. Deep regressed light head position to minimize the glare.

Moto-Gimbalo Surface have a diameter of 203mm and a height of 176mm. Two remote controlled DC motors drive the movements of the fixture, which is tiltable vertically 0-40° in all direction on a dual axis gimbals.

The movements of the fixture, as well as the intensity and the colour tuning of the light, are controlled via LaserDim™ remote control or CASAMBI™ application.

Accessories

No accessories available

Finish

Powder coat in black or white colour.

LED sources

COB LED, High Power LED.
CRI: 90 | CCT: 3000K, 4000K.
Other CRI and CCT options, Tuneable White and DimToWarm versions available on request

Optic

Lens.
Narrow, medium and wide beam angle available.

Driver

Supplied with integrated dimmable driver.
Motion Control: Casambi, LaserDim.
Dimming Options: Casambi, LaserDim, 0-10V, DALI.

Applications

Motorized ceiling mounted luminaire with simple design used to provide ambient or accent lighting.
Application areas: residential, retail, galleries, restaurants, hotels, lobbies, corridors.

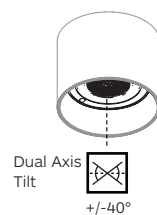

Moto-Gimbalo Surface



Moto-Gimbalo

Surface

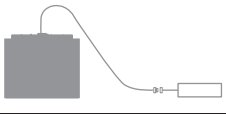
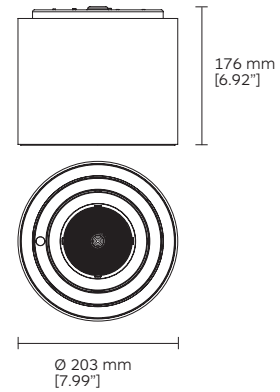

Code ordering example: **M103BC33-903015DL10**

	Product code	Light source code*	>CRI	CCT**	LED power	Nominal lumen	Beam angle (BA°)	Driver Options	Finish	
Moto - Gimbalo Surface	M103	BC33 COB LED	90	30 3000K	17W	1934 lm	15 / 24 / 38	DL Laser Dim	10 ■ Black	
			40	4000K					11 □ White	
		BR21	4 x High Power LED	90	30 3000K	21W	1862 lm	07 / 24 / 36	D1 0 - 10 Dim	
				40	4000K					DX DMX

Notes:

* For complete code ordering information, please see page 97.

** For other CCT options, Tuneable White (TW)  version please contact us.
PATENTED

Moto-Gimbalo Pendant



Body

Motorized pendant mounted spotlight with light body and mounting clamps in cast aluminium. Supplied with ceiling canopy and pre-installed 2 x 1.5m pendant steel wires inclusive of electrical connection.

The entire luminaire is tiltable vertically up to 45° in two directions. Furthermore the internal light head is tiltable 320°.

The movements of the fixture, as well the intensity and the white colour tuning of the light, are controlled via LaserDim™ remote control or CASAMBI™ application.

Accessories

No accessories available

Finish

Powder coat in black and white colour.

LED sources

COB LED, High Power LED.
CRI: 90 | CCT: 3000K, 4000K.
Other CRI and CCT options, Tuneable White and DimToWarm versions available on request

Optic

Lens.
Narrow, medium and wide beam angle available.

Driver

Supplied with integrated dimmable driver.
Motion Control: Casambi, LaserDim.
Dimming Options: Casambi, LaserDim, 0-10V, DALI.

Applications

Pendant luminaire with a modern look, providing direct/indirect illumination. Thanks to the MOTOLUX technology can be adjusted to accurately aimed the zone to illuminate.
Application areas: museums, retail, restaurants, hotels.

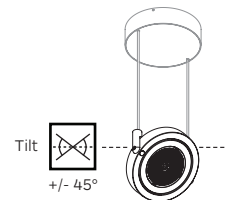
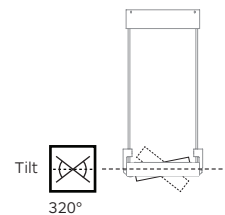

Moto-Gimbalo Pendant

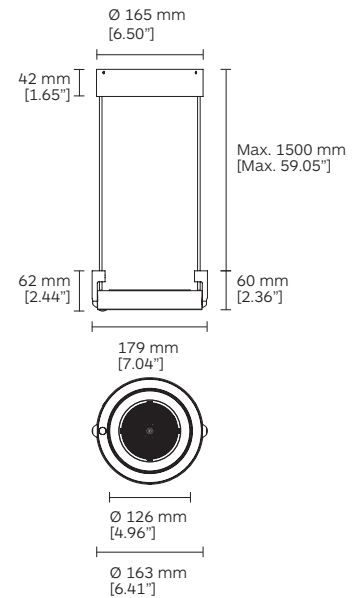
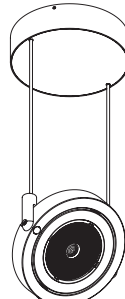
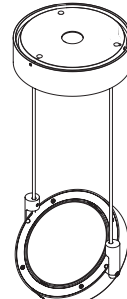
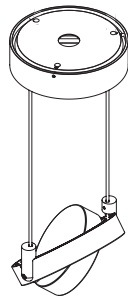
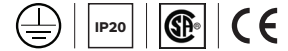

Code ordering example: **M 7 0 5 B C 3 3 - 9 0 3 0 1 5 D L 1 0**

	Product code	Light source code*	>CRI	CCT**	LED power	Nominal lumen	Beam angle (BA°)	Driver Options	Finish
Moto-Gimbalo Pendant	M705	BC33	COB LED	90	30 3000K	17W 1934 lm	15 / 24 / 38	DL Laser Dim DC CASAMBI D1 0 - 10 Dim	10 ■ Black 11 □ White
				40 4000K		2041 lm			
		BR21	High Power LED	90	30 3000K	21W 1862 lm	07 / 24 / 36		
				40 4000K		1920 lm			

Notes:

* For complete code ordering information, please see page 97.

** For other CCT options, Tuneable White (TW)  version please contact us. PATENT pending.

Sistema Moto-MultiGimbalo



Body

Motorized pendant mounted system luminaire. The three independent light heads and the luminaire trim are made of cast aluminium.

Sistema Moto-MultiGimbalo Pendant have a length of 1000mm and a width of 249mm. The luminaire is Supplied with ceiling canopy, a pre-installed 1.5m electrical cable and 4x1.5m pendant steel wires.

Two remote controlled DC motors drive the movements of the fixture, which is Tilttable vertically 0-40° in all directions on a dual axis gimbals. The movements of the fixture, as well as the intensity and the colour tuning of the light, are controlled via LaserDim™ remote control or CASAMBI™ application.

Accessories

Linear spread, honeycomb louvre, snoot, visor.
For more information about accessories see page 83.

Finish

Powder coat in black and white colour.

LED sources

COB LED, High Power LED.
CRI: 90 | CCT: 3000K, 4000K.
Other CRI and CCT options, Tuneable White and DimToWarm versions available on request

Optic

Lens.
Narrow, medium and wide beam angle available.

Driver

Supplied with integrated dimmable driver.
Motion Control: Casambi, LaserDim.
Dimming Options: Casambi, LaserDim, 0-10V, DALI.

Applications

A elegant and neat design for excellent visual comfort. Ideal for maintaining a minimalist and clean ceiling aesthetic.
Applications areas: retail, hotels, restaurants, hospitals, lobbies, car showrooms.

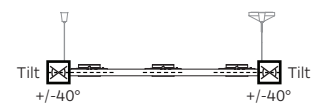

Sistema Moto-MultiGimbalo

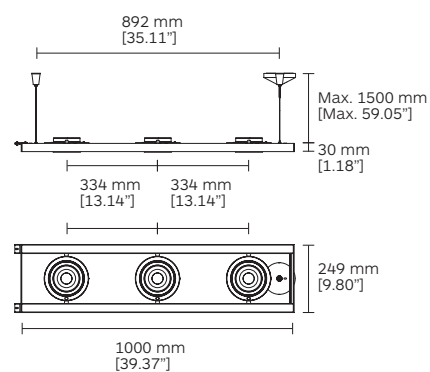

Code ordering example: **M 7 0 6 B C 3 3 - 9 0 3 0 1 5 D L 1 0**

	Product code	Light source code*	>CRI	CCT**	LED power	Nominal lumen	Beam angle (BA°)	Driver Options	Finish	
Sistema Moto-MultiGimbalo	M706	BC33	COB LED	90	30 3000K	3x17W	5802 lm	15 / 24 / 38	DL Laser Dim	10 ■ Black
				40	4000K		6123 lm			DC CASAMBI
		BR21	High Power LED	90	30 3000K	3x21W	5586 lm	DA DALI Dim	D1 0 - 10 Dim	
				40	4000K		5760 lm			

Notes:

* For complete code ordering information, please see page 97.

For related accessories, please see page 82-83.

** For other CCT options, Tuneable White (TW)  version please contact us. PATENT pending.

Moto-Lineavolo



Body

Motorized pendant mounted luminaire. The light body is made of cast aluminium. Moto-Lineavolo is available in 2 different length: 900mm and 1200mm.

The luminaire is supplied with ceiling base and two pre-installed pendant steel wires inclusive of electrical connection. A remote controlled DC motors regulates the height of the wires between 500mm and 1000mm.

The movements of the fixture, as well as the intensity and the colour tuning of the light, are controlled via CASAMBI™ application.

Accessories

No accessories available

Finish

Anodized coat in gold, natural aluminium, black and white colour.

LED sources

SMD.

CRI: 97 | R9: >90 | CCT: 2700K, 3000K, 3500K, 4000K | 3-Step McAdam.

Other CRI and CCT options available on request.

Optic

Supplied with semi transparent diffuser. Opal white diffuser available on request.

Beam angle: extra wide (120°).

Driver

Inclusive of integrated LaserDim™ or CASAMBI driver.

Diming Options: Scene by CASAMBI.

Applications

LineaVolo blends the line between architectural and decorative. Its motorized version add the flexibility of the MOTOLUX range to the elegance of LineaVolo family.

Application Areas: residential, hospitality, restaurants, corridors, offices.

Moto-Lineavolo



Moto-Lineavolo

Pendant

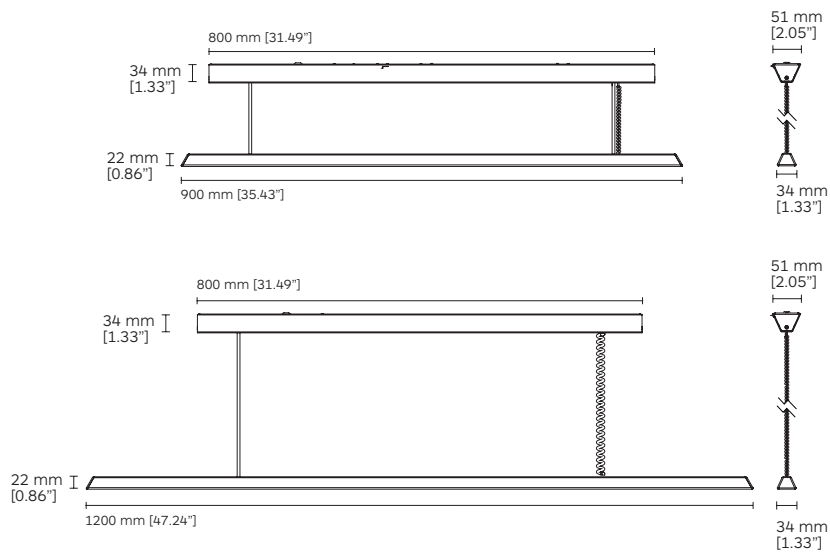

Code ordering example: **M7070900-903000DC10**

	Product code*	Length code	Light Source	>CRI	CCT**	LED Power	Normal Lumen	Beam angle (BA°)	Driver Options	Finish
Moto-Lineavolo	M707	0900	LED	90	30 3000K	17W	1595 lm	00	DC CASAMBI	10 ■ Black
					40 4000K		1595 lm			11 □ White
		1200				23W	2145 lm			79 ■ Natural Aluminium
							2145 lm			35 ■ Gold

Notes:

* For complete code ordering information, please see page 97.

** For other CCT options, Tuneable White (TW)  version please contact us.

Moto-Gimbalo Terraluce

Recessed & On ground

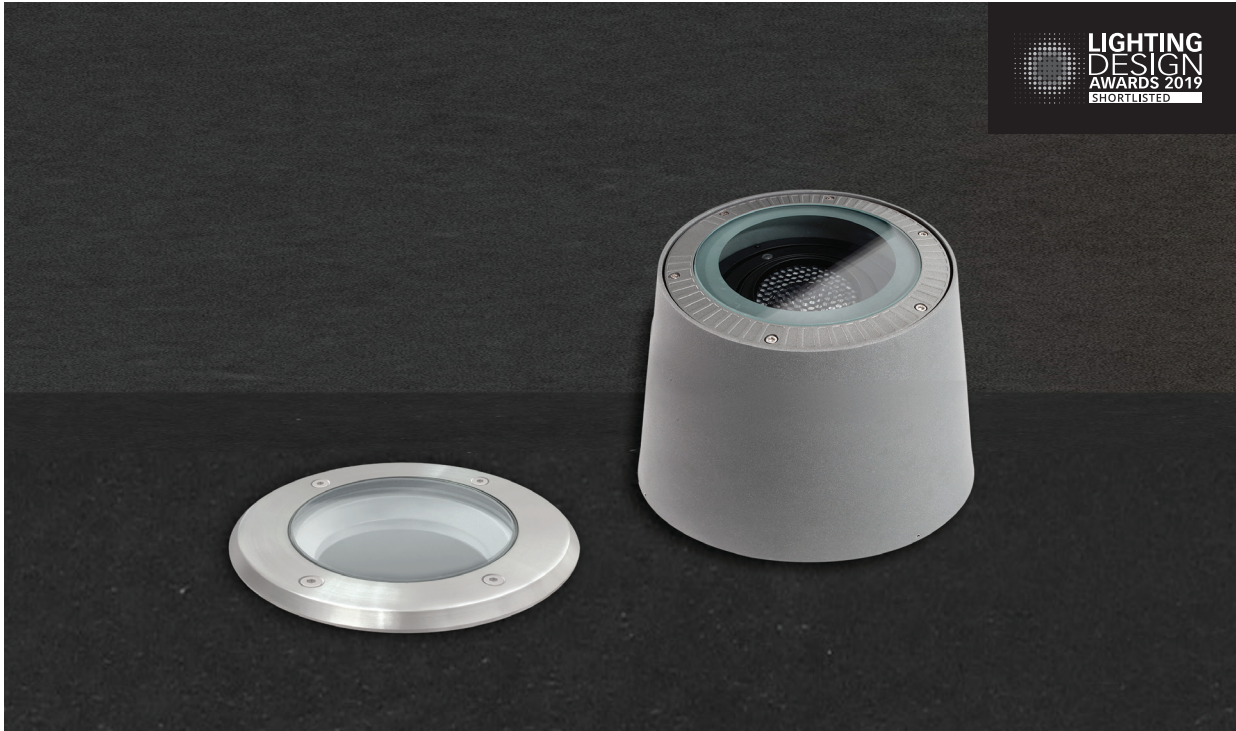

Body

Motorized outdoor luminaire. Available in two version: ground recessed or on-ground mounted. Luminaire trim is made of stainless steel, internal light head in cast aluminium, on ground version body in painted metal. The fixture, also, included a toughened safety glass, a weatherproof durable silicone gasket and external stainless steel screws.

Two DC motors drive the movements of the fixture, which is tilttable vertically 0-40° in all directions on a dual axis gimbals.

The movements of the fixture, as well as the intensity and the colour tuning of the light, are controlled via CASAMBI™ application.

Accessories

Linear spread, honeycomb louvre.
For more information about accessories see page 83.

Finish

Powder coat in Stainless steel (AISI316).

LED sources

High Power LED, Lumenetix Full Spectrum.
CRI: 90 | CCT: 3000K, 4000K, FS.
Other CRI and CCT options, Tuneable White and DimToWarm versions available on request

Optic

Lens.
Narrow, medium and wide beam angle available.

Driver

Supplied with integrated dimmable driver.
Motion Control: Casambi, LaserDim.
Dimming Options: Casambi, LaserDim, 0-10V, DALI.
Colour Tuning: Casambi, DMX.

Applications

Neat designed uplighting luminaire perfect to wall wash or highlight outdoor architectural structures or surfaces
Shortlisted at the Lighting Design Awards 2019.
Application areas: facades, parks, golf courses, driveways, sculptures.

Moto-Gimbalo Terraluce
Recessed

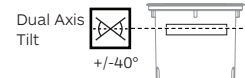

Moto-Gimbalo Terraluce
On ground

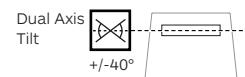

Moto-Gimbalo Terraluce



Moto-Gimbalo Terraluce

Recessed

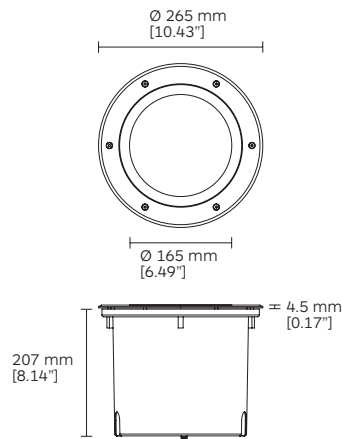

Moto-Gimbalo Terraluce

On ground

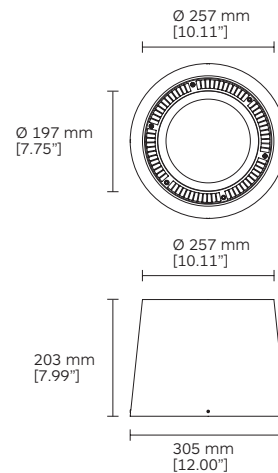

Code ordering example: **M301MR21-903007DL84**

	Product code	Light source code*	>CRI	CCT**	LED Power	Norminal Lumen	Beam angle (BA°)	Driver Options	Finish
Moto-Gimbalo Terraluce Recessed	M301	MR21 High Power LED	90	30 3000K	21W	1862 lm	07 / 24 / 36	DL Laser-Dim	84 ■ Stainless Steel
				40 4000K		1920 lm		DC CASAMBI	29 ■ Grey
Moto-Gimbalo Terraluce On ground	M302	BL22 Lumenetix ¹	90	FS Full Spectrum	18W	750 im	14 / 22 / 36	DA Dali Dim D1 0-10 Dim DX DMX	

Notes:

* For complete code ordering information, please see page 97.

For related accessories, please see page 82-83.

** For other CCT options, Tuneable White (TW)  version please contact us.

¹ Tuning range: 1650-8000K. Gradients of saturated colours from 1-100% can be added to colour points within the tuning range.

¹ The values in the nominal lumen are referring to the peak lumen.

PATENTED.

Optical Accessories Track Systems

Optical Accessories



Product / Optical Accessories		Linear Spread Colour 10	Honeycomb Louvre Colour 10	Visor Colour 10	Visor Colour 10	Snoot Colours 10
Low Voltage Track	Moto-Zero Low Voltage 68	2A51	2A54	2A60	/	2A65
	Moto-Zero Low Voltage 100	/	2C70	/	/	/
Track	Moto-Zero Compasso 68	2A51	2A54	2A60	/	2A65
	Moto-Zero 66					
	Moto-Zero 100	2A50	2A53	2A64	/	2A59
	Moto-Zero 130	2A49	2A52	2A63	/	2A58
	Moto-Zero Zoom 130	/	2D95	/	/	/

Optical Accessories



Product / Optical Accessories		Linear Spread Colour 10	Honeycomb Louvre Colour 10	Visor Colour 10	Visor Colour 10	Snoot Colours 10	
Recessed	Moto-Combo	/	2334	/	/	/	
	Moto-Zero In & Out 66	2A51	2A54	2A60	/	2A65	
	Moto-Palla In & Out 70		2B95				
	Moto-Palla In & Out 100	/	2B99	/	/	/	
	Moto-Palla In & Out 130		2C04				
	Moto-Colosseo 90		2504				
	Moto-Colosseo 120	/	2633	/	/	/	
	Moto-Gimbalo 60	2663	2634	/	2A85	2A91	
	Moto-Gimbalo 130	2A68	2334	/	2A83	2A89	
	Moto-MultiGimbalo 60	2663	2634	2321	/	/	
	Moto-MultiGimbalo 130	2598	2334	2327	/	/	
	Pendant	Sistema Moto-MultiGimbalo	2598	2334	2327	/	/
	Outdoor	Moto-Gimbalo Terraluce Recessed					
Moto-Gimbalo Terraluce On Ground		2598	2334	2327	/	/	

Low Voltage Track Options

Recessed Trim Track

2ST8 + Art. 9202 Bracket with spring for 2ST8

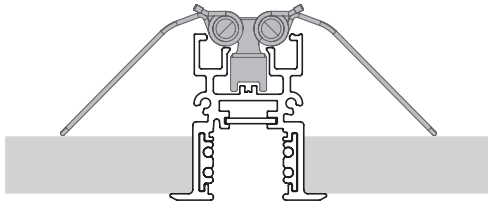

Recessed Trimless Track

2ST3 + Art. 9201 Bracket for 2ST3 trimless track

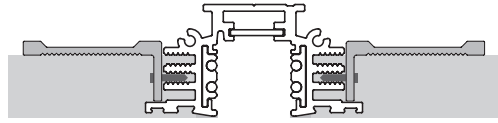

Pendant Track

2ST6 +
Pendant
Kits

Art.9226

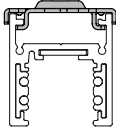

2ST7 +
Pendant
Kits

Art.9226

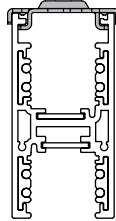

Pendant Kit

Pendant
Kit
Art. 9226

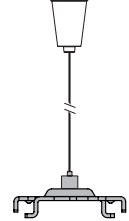

Surface Track

2ST6 +
Surface
Kits

Art.9225

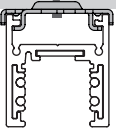

2ST1

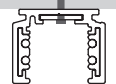

Surface Kit



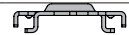

Surface
Kit
Art. 9225

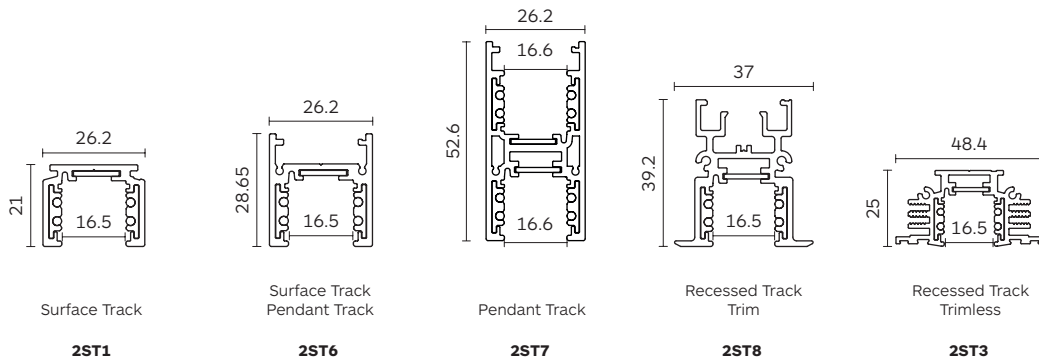

Low Voltage Track

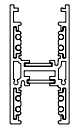

Compatibility

Track Options/ Product name					
	Surface Track 2ST1	Surface Track Pendant Track 2ST6	Pendant Track 2ST7	Recessed Track Trim 2ST8	Recessed Track Trimless 2ST3
			Up & Down		
Moto-Zero Low Voltage	✓	✓	✓	✓	✓
Moto-Zero Zoom Low Voltage	✓	✓	✓	✓	✓

Accessories

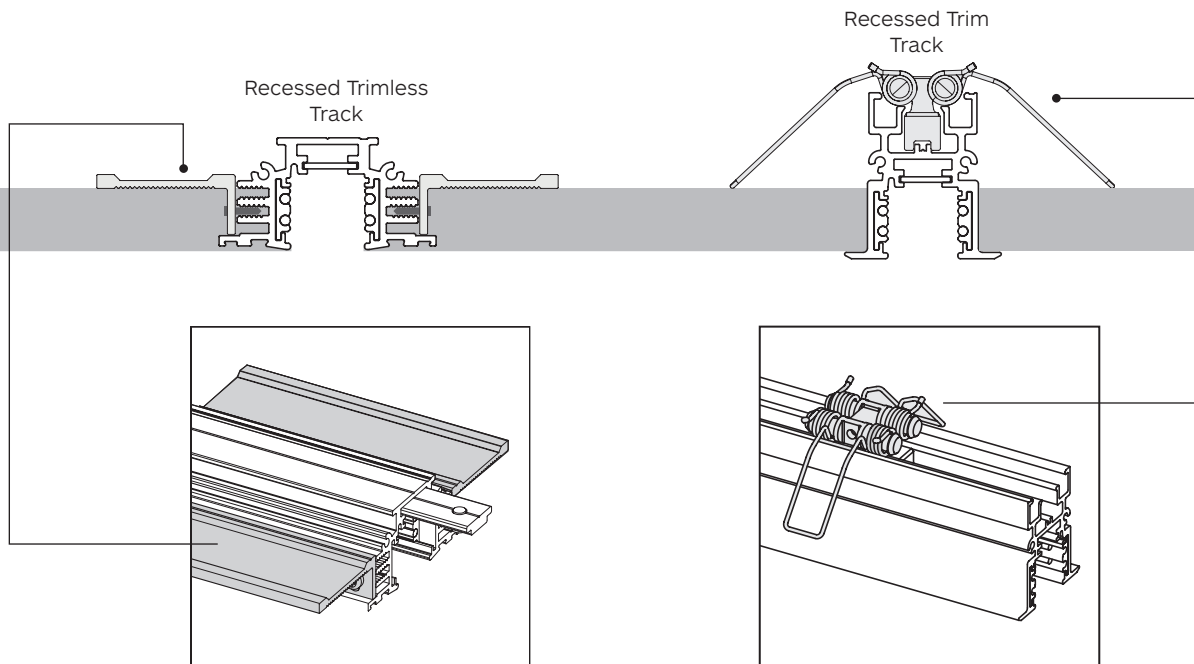

Bracket for 2ST3 Trimless Track

Art. 9201

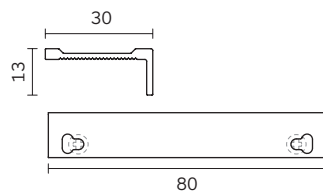

Bracket with Spring for 2ST8

Art. 9202

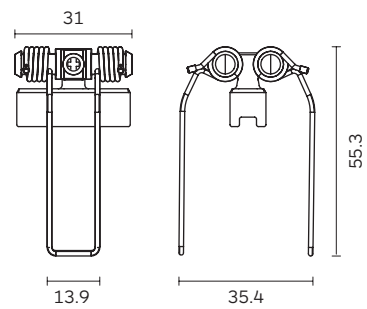

Surface Track

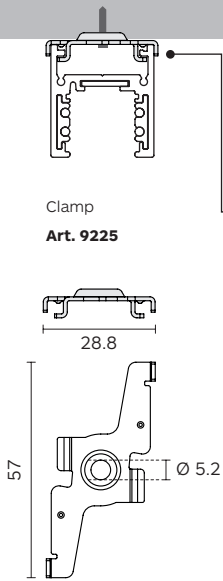

Pendant Track

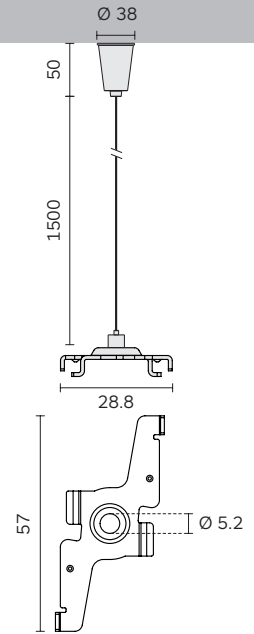

Clamp with wire Hanger
Art. 9226

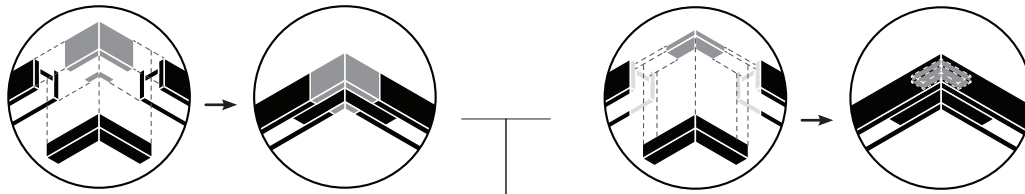

9231
Cover for L Joint
(For 2ST6)

9215
L Bracket for angles

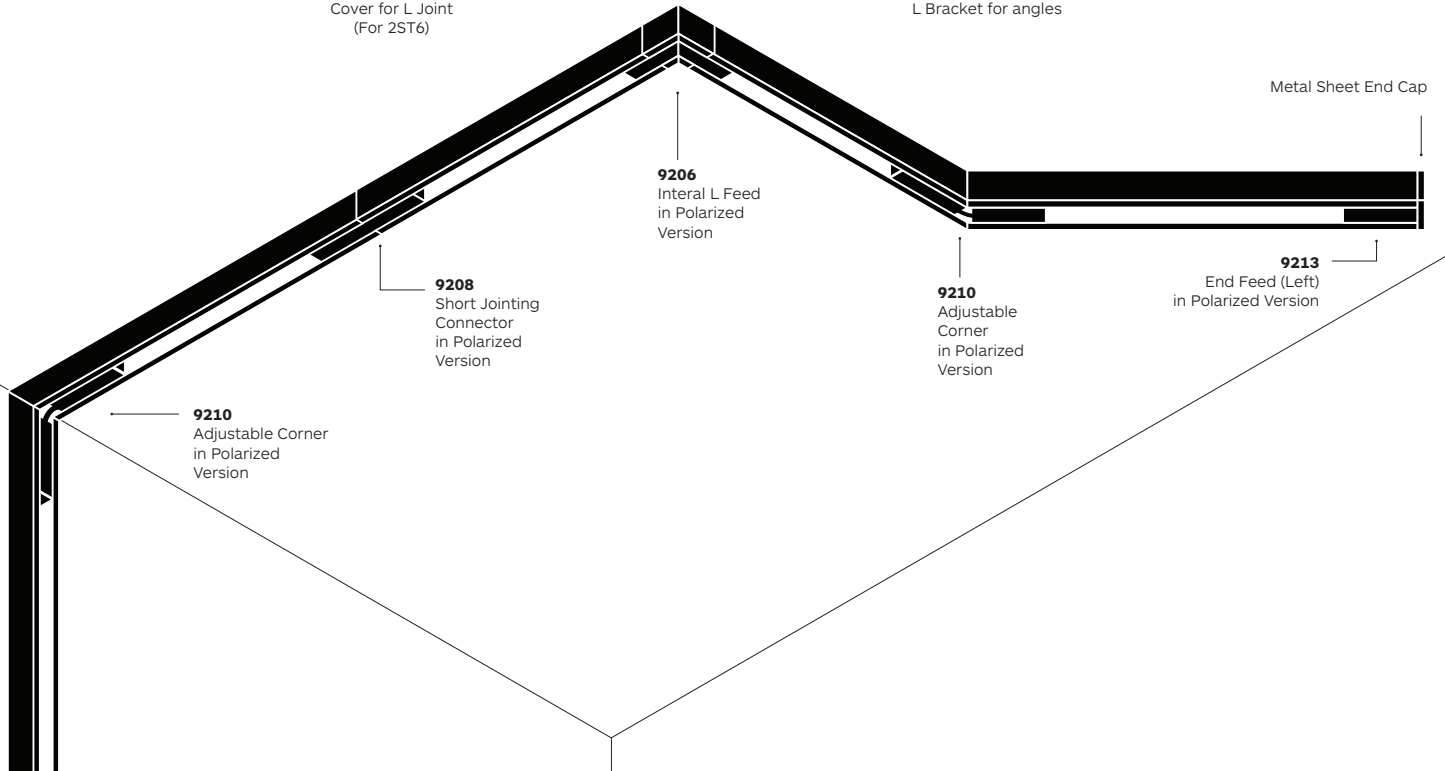

Reference Diagram for Choice of Connectors

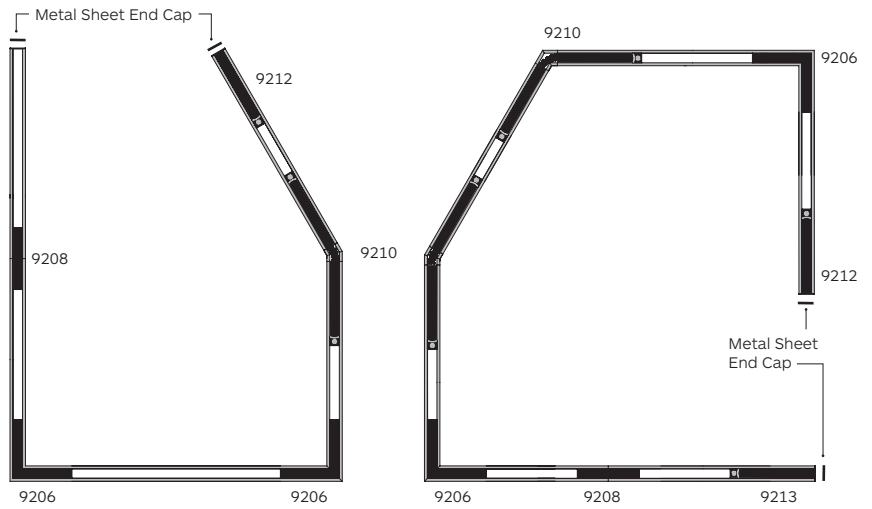

9212
End Feed (Left) in Polarized Version

Metal Sheet End Cap

Installation Components

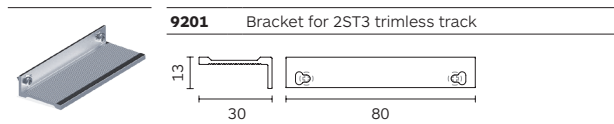

9201 Bracket for 2ST3 trimless track

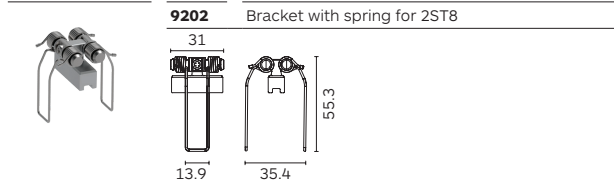

9202 Bracket with spring for 2ST8

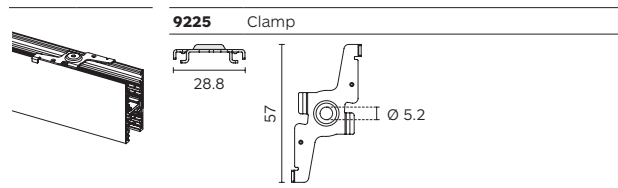

9225 Clamp

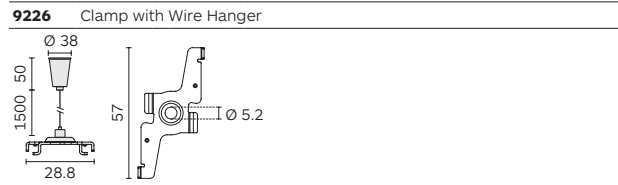

9226 Clamp with Wire Hanger

Accessories

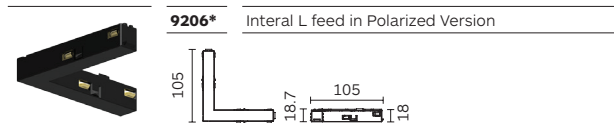

9206* Interl L feed in Polarized Version

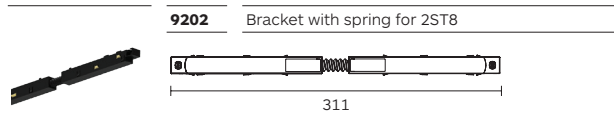

9202 Bracket with spring for 2ST8

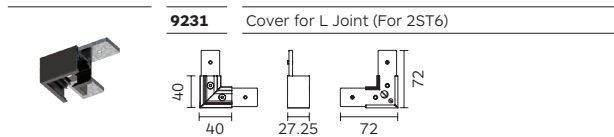

9231 Cover for L Joint (For 2ST6)

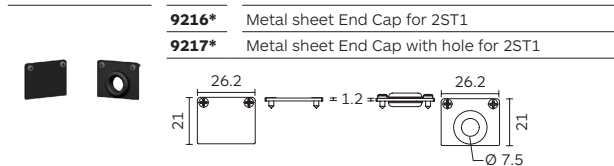

9216* Metal sheet End Cap for 2ST1

9217* Metal sheet End Cap with hole for 2ST1

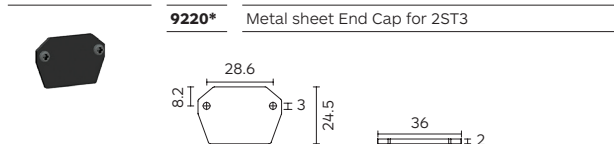

9220* Metal sheet End Cap for 2ST3

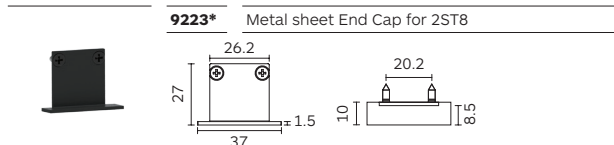

9223* Metal sheet End Cap for 2ST8

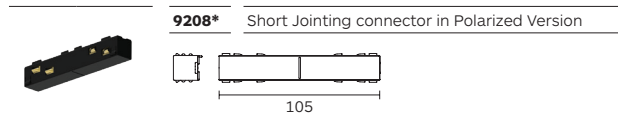

9208* Short Jointing connector in Polarized Version

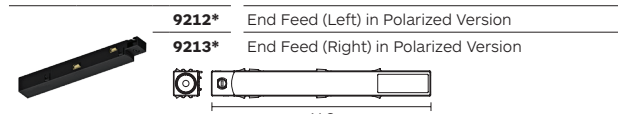

9212* End Feed (Left) in Polarized Version

9213* End Feed (Right) in Polarized Version

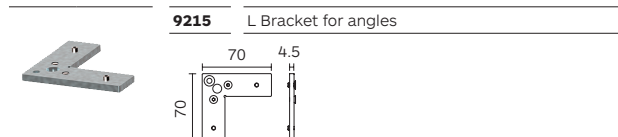

9215 L Bracket for angles

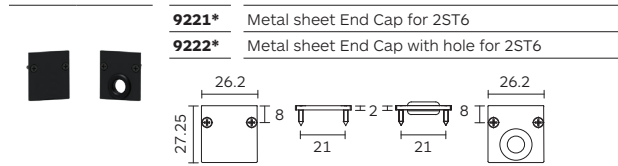

9221* Metal sheet End Cap for 2ST6

9222* Metal sheet End Cap with hole for 2ST6

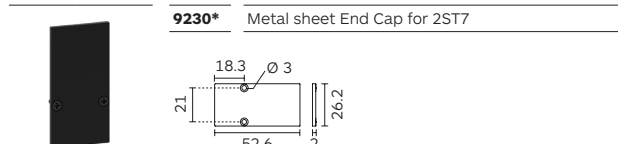

9230* Metal sheet End Cap for 2ST7

Notes:

* Available in colours 10, 11

Power Supply Options

Power Supply



220-240VAC input,
48VDC output 75w power
supply for low voltage
track



220-240VAC input,
48VDC output 150w power
supply for low voltage
track



220-240VAC input,
48VDC output 240W,
DIN rail power supply unit
for low voltage track



220-240VAC input,
48VDC output 480w,
DIN rail power supply unit
for low voltage track

Code

2E28

2E29

2E30

2E31

Size

100 x 235 x 31

100 x 235 x 31

Max. 63 x 125.2 x 113.5

Max. 85.5 x 125.2 x 128.5

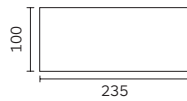
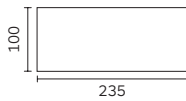

Drop Voltage Table

Power Supply (W)	A Distance power supply/feed unit (2x1.5mm ²)			
	5m	10m	20m	30m
	B Track Length with $\Delta v \leq 5.5\%$ (m)			
	(m)	(m)	(m)	(m)
60	50	50	50	50
100	50	50	40	25
150	50	40	20	Not admitted
200	40	30	Not admitted	Not admitted
250	35	20	Not admitted	Not admitted

Information refers to a load equivalent to the power supplied and equally distributed on the relevant length in the table.

Remote Power Supply

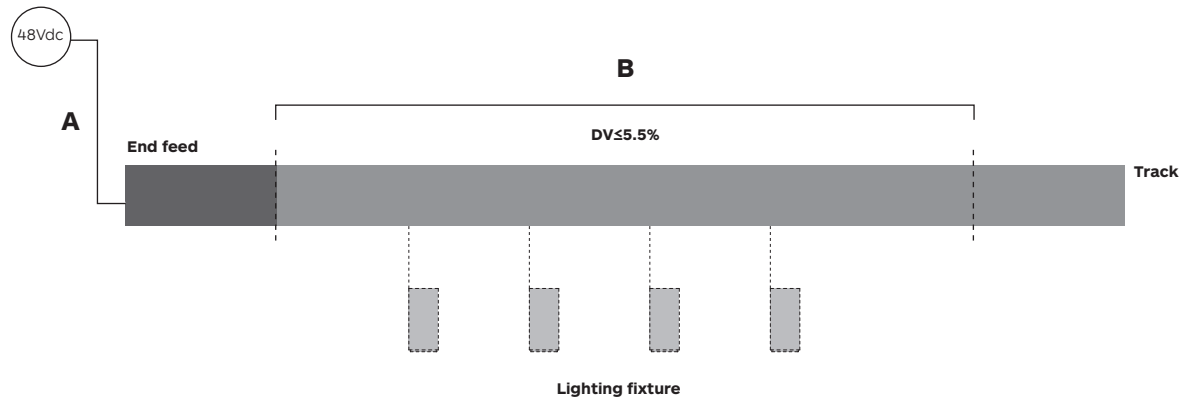

Eurotype Track System with Dali Support



Product Code	Length Code	Length (L)
2D65	1000	1m
2D65	2000	2m
2D65	3000	3m

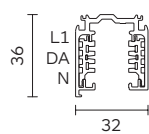

Product Code	Length Code	Length (L)
2D66	1000	1m
2D66	2000	2m
2D66	3000	3m

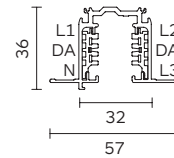

Finish
10 ■ Black
11 □ White
75 ■ Grey

Notes: Connection to the 220-250V single-phase mains: 16A overall load, corresponding to 3500/4000 VA over the three circuits.

Features

Three circuit main-voltage track system with Data Bus.

Track in extruded aluminium fitted with four 16A rolled copper conductors and 2 conductors for Data signal housed in extruded insulated black thermoplastic.

Equipped with three separately controllable current circuit.

Completed of a vast range of accessories to fit to the needs of any specific project.



Directive Lug

- The drawing is Reflected Ceiling View.
- Directive Lug on the back of connectors.

Reference Diagram for Choice of Connectors (Surface Mounted Track)

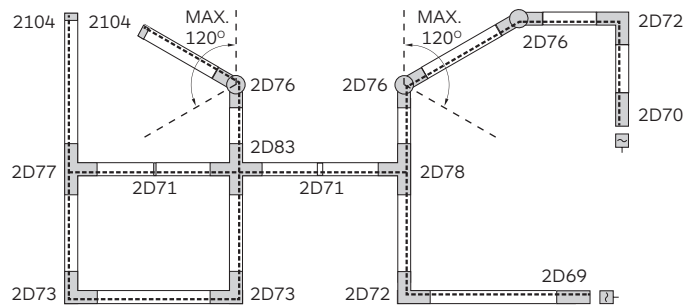

Reference Diagram for Choice of Connectors (Flanged Recessed Track)

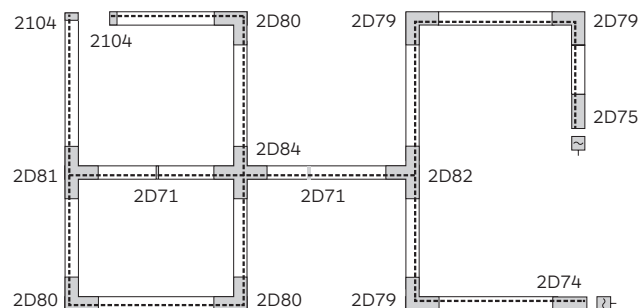

Installation Components

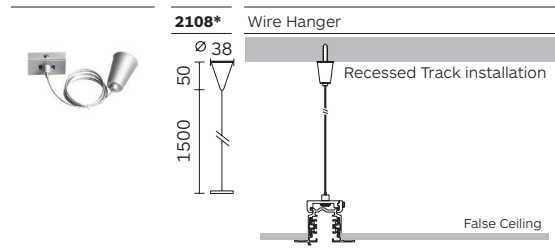
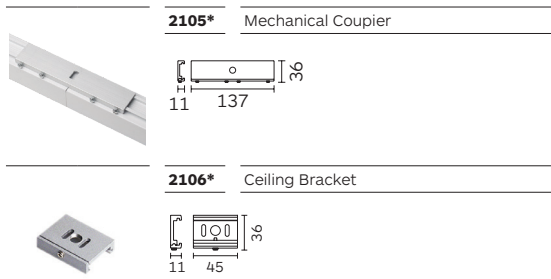

Accessories

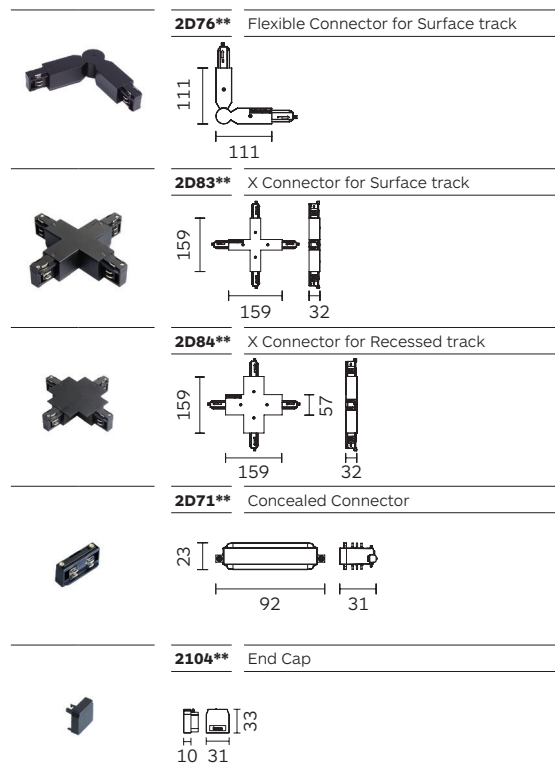
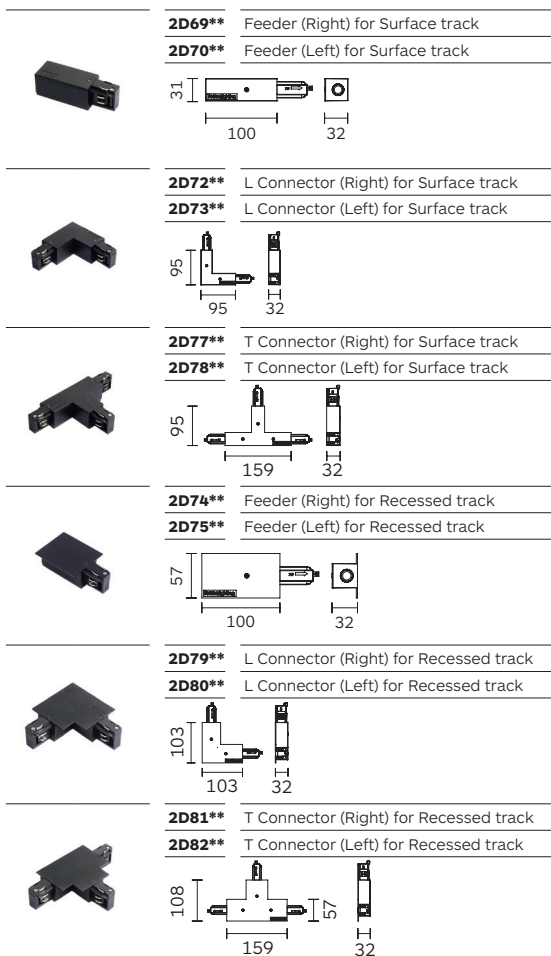

Notes:

- * Available in colours 10, 11, 75.
- ** Available in colours 10 & 11.

Symbols & Icons
Code system
Global presence

Symbols & Icons

Trim Round	
Trim Square	
Trimless Round	
Trimless Square	
Round ceiling cut	
Square ceiling cut	
Zoom	

The CE mark signifies that a product conforms with the relevant ECC directives requirements. The CE marking is compulsory to indicate LVD and EMC conformity.

The CE mark is also a self certification that the manufacturer claims that the product is safe. The value of such claim is directly related to the case of FormaLighting: All products are designed, developed, manufactured under the scope of ISO 9001 quality systems.



All formaLighting products are tested in Europe and certified by an independent laboratory that is registered and audited by an approved European testing authority.

Others third party product approvals

Our products include electrical and electronic components that carry other world wide Test House approvals such as those shown:



CLASS I

Luminaires of insulation Class I - with earth connector.



CLASS II

Luminaires of insulation Class II - With safety isolation, this means the tension conduction element are protected by additional isolation.

The isolation of an earth wire it is not necessary and the connection to it is not allowed.



CLASS III

Luminaires of isolation Class III - designed for operation of protected low voltage supplied (>42V).



Passes the 850C glow wire test in accordance with ICE 695-2-1.



Degree of Ingress Protection*



Recyclable	
Dim2Warm	
Tuneable White	
RGB / W	
CASAMBI	

IP__ Degree of Ingress Protection

1st Number	Protection Against Dust and Solid Objects	2nd Number	Protection Against Moisture and Liquids
0	No-Protection	0	No-Protection
1	Protection against solid objects >50 mm	1	Protection against dripping water
2	Protection against solid objects >12 mm	2	Protection against dripping water tilted > 15 deg
3	Protection against solid objects >2.5 mm	3	Protection against spraying water > 30 deg
4	Protection against solid objects >1 mm	4	Protection against spraying water
5	Dust - protected	5	Protection against water jet
6	Dust - tight	6	Protection against waves
		7	Protection against the effects of immersion
		8	Protection against submersion

LEDs in formalighting Luminaires

Lumenetix
Citizen
Cree
Luminus
Osram
Nichia

Code system

Code ordering example: **M 6 2 1 | I C 3 2 - 9 0 | 3 0 | 1 5 | D L | 1 0**

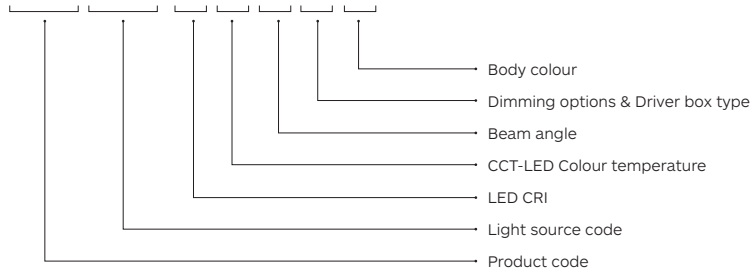

Dimming options	Driver box type options	
	Type D	Type S
Laser Dim	DL	
CASAMBI	DC	
DMX	DX	SX
Dali		SA
0 - 10 Dim	D1	

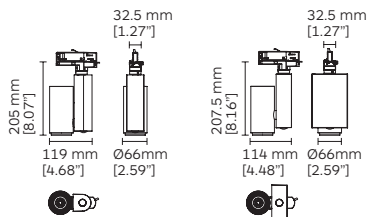

LED CRI	
90	CRI > 90
95	CRI > 95

Driver Options	
DL	Laser Dim
DC	CASAMBI
DX	SX DMX
	SA Dali Dim
D1	0 - 10 Dim

CCT-LED Colour temperature	
27	Warm White 2700K
30	Warm White 3000K
40	Neutral White 4000K
DW	Dim2Warm™ 1800-3000K
TW	Tuneable White™ 2700K - 6500K
FS	Full Spectrum

Body Colour	
10	Black (RAL 9004)
11	White (RAL 9003)
*17	Black (RAL 9004) / White (RAL 9003) (B&W)
27	Chrome Polished
35	Gold
75	Grey (RAL 9006)
29	Grey (for Outdoor use)
84	Stainless steel

Notes:
***17:** white light body with black integrated louvre. For black body with white integrated louvre consult us.

How to order

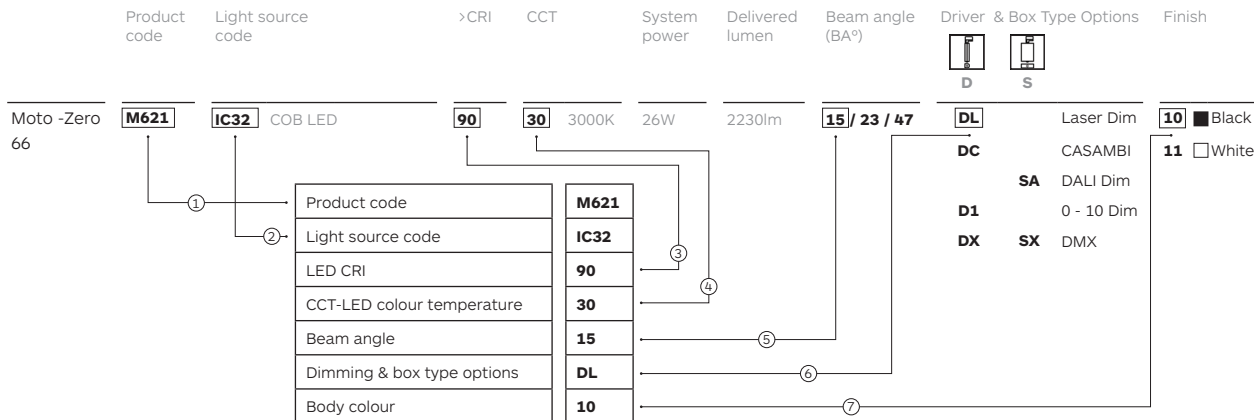

All dimensions in the catalogue in mm & inches

Global presence

Celebrating 50 years of vision, dedication and innovation, Formalighting's versatile and high-quality product offerings extends internationally via our headquarters in Hong Kong, London, Milan, Shanghai and the USA.

Our well chosen and selected partners as well as our affiliated international offices broaden our global presence further in markets such as Australia, Japan, South East Asia, India and the Middle East.

Through our commitment to growth and investment within formalighting's professional team, infrastructure and product ranges, we are able to provide increasing service to our global retail and hospitality clients as well as lighting designers and specifiers strengthening our position as a leading international supplier of innovative architectural lighting solutions and systems.

With 50 years' experience in designing and manufacturing architectural lighting, formalighting's comprehensive portfolio offers a competitive range of European designed and expertly engineered products that carry CB, CE, CCC and UL certifications.

Furthermore formalighting's latest award-winning motorized range of track, pendant, and recessed fixtures, featuring remote-controlled adjustable pan and tilt, dim, dim to warm, tuneable white and beam shaping lens, are available worldwide incorporating the latest, most advanced lighting technologies.

Headquarters

Europe / Milan

Tel (+39) 02 9354 0300

Fax (+39) 02 9343 5117

E-mail formaitalia@formalighting.it

Asia / Hong Kong

Tel (+852) 2516 6500

Fax (+852) 2516 6525

E-mail forma@forma.com.hk

USA / New York

Tel (+1) 470 419 4003

E-mail info.us@formalighting.com

Formalighting is constantly developing and improving its products therefore all information, drawings illustrations, specifications, photometric values in this catalogue are indicative and shall not form part of any commitment to our company that reserve the right to change specifications without prior notification or public announcement. Technical information on the installation-instruction has precedence over the information in the catalogue. Our general terms and conditions shall apply notwithstanding any stipulation on the contrary to all the orders and agreement with formalighting. You can obtain a copy of these conditions on demand.

Publication date: June 2020
©Copyright formalighting

With thank to all contributors for the realization of this catalogue

Designed by formalighting Graphic Design Department

No part of this catalogue may be copied without written authorization of formalighting

formalighting

HONG KONG

-

LONDON

-

MILAN

-

SHANGHAI

-

NEW YORK

formalighting

LV Track

48V Low Voltage Track System

2020 | 21

48V Low Voltage Track System

48V Low Voltage Track System

Polaris
Low Voltage



p.10

Polaris Wallwasher
Low Voltage



p.10

Polaris Opal Diffuser
Low Voltage

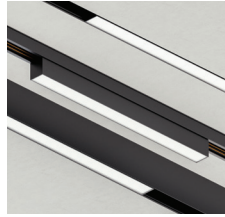

p.12

Polaris Extended Arm
Low Voltage



p.14

Zero
Low Voltage



p.16

Zero Long Arm
Low Voltage



p.18

Zero **Zoom**
Low Voltage



p.20

Zero **Zoom** Long Arm
Low Voltage



p.20

Ola
Low Voltage



p.22

Ola **Zoom**
Low Voltage



p.24

Rolo
Low Voltage



p.26

Dado
Low Voltage



p.26

Conos
Low Voltage



p.28

48V Low Voltage Track System

Polaris
Low Voltage Pendant

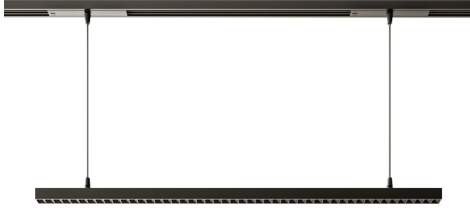

p.30

Polaris
Opal Diffuser Low Voltage Pendant



p.32

Pixo
Low Voltage Pendant



p.34

Pixo **Zoom**
Low Voltage Pendant



p.36

Palla
Low Voltage Pendant



p.38

Low Voltage Track
Options

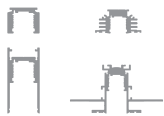

p.40

Accessories



p.42

Power Supply &
Control Options



p.46

Code Ordering
System



p.51

Low Voltage Track, High Performance Luminaires





2ST9

Zero Zoom
P.20

2ST7

Zero
P.16

Conos
P.28

2ST2

Dado
P.26

Rolo
P.26

Palla
Pendant
P.38

Polaris
P.10

2ST6

Polaris
Wallwasher
P.10

Ola
P.22

Polaris
Opal Diffuser
P.12

Ola
Zoom
P.24

2020
product
release

formalighting

New Low Voltage Track System

formalighting

MOTOLUX

Motorized Architectural Lighting

Formalighting's new 48V low voltage system is a flawless and flexible solution for any environment. Its miniature dimension helps to maintain a minimalist aesthetic.

The system offers deep recessed, recessed, surface and pendant mounted solutions. Our most popular formalighting and MOTOLUX – architectural motorized lighting – luminaires are now compatible with the 48V LV system.

The light modules are easy to insert or to remove from the track and immediately ready to work.

Our comprehensive portfolio also offers different types of optics (lens spot, opal diffuser, wallwasher) and beam angles. Specific solutions, such as beam shaping function, super narrow beam and high CRI performance are also available in the 48V LV system, offering designers more flexibility than any other low voltage system on the market.

Polaris Low Voltage

Low Voltage Track

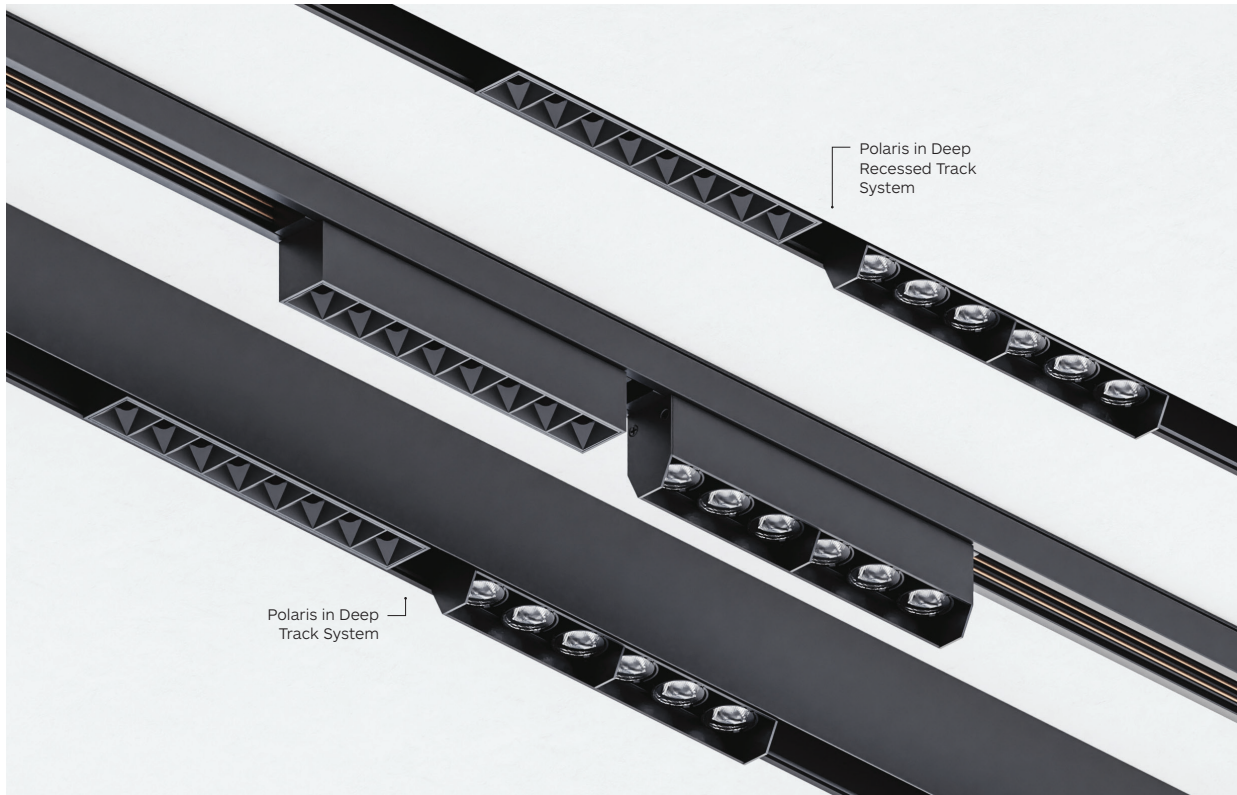

Body

Track mounted 48V low voltage spotlight with light body in extruded aluminium.

Standard version is inclusive of Integrated diamond faceted no-dazzle screen in thermoplastic. Wallwasher version is inclusive of integrated louvre.

Integrated track adapter, compatible with different models of Stucchi low voltage track system.

Easy to insert and remove from the track.

Available in different configurations.

Accessories

For more information about low voltage track accessories see page 40-45.

Finish

Powder coat in black or white. White version available also with integrated black thermoplastic screen.

LED sources

Light source options: High Power LED.
CRI: 90 | CCT: 3000K, 4000K.

Other CRI, CCT and Tuneable White options available on request.

Optic

Lens plus thermoplastic screen.

UGR < 16.

Five different beam angles available.

Wallwasher optic available.

Driver

Integrated 48V DC input.

Diming Options: 0-10V, DALI, Casambi.

Check page 46 for more details about diming options.

Power supply unit to be ordered separately, see page 46.

Applications

An innovative solution for high brilliance and performance. The light source is barely visible, as the miniature light heads create a high contrast and linear light emission. Application areas: residential, hotels, restaurants, retail, corridors.

Compatible with Low Voltage Track Types

Please see P.40-41 for details



2ST1
Surface Track



2ST6
Surface Track
Pendant Track



2ST2
Deep Surface Track
Deep Pendant Track



2ST7
Pendant Track
For Down Side



2ST9
Deep Pendant Track
For Down Side



2ST8
Recessed Track
Trim



2ST3
Recessed Track
Trimless



2ST5
Deep Recessed
Track Trimless



2STA
Deep Recessed
Track Trimless

Polaris 20 Low Voltage & Polaris 20 Wallwasher Low Voltage



Polaris 20 Low Voltage

Low Voltage Track with 4 LEDs

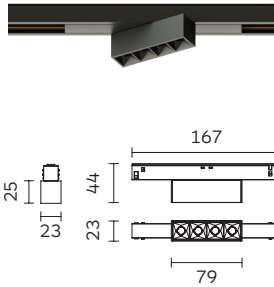

Low Voltage Track with 8 LEDs

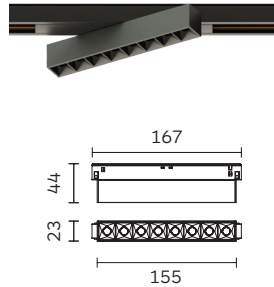

Low Voltage Track with 12 LEDs

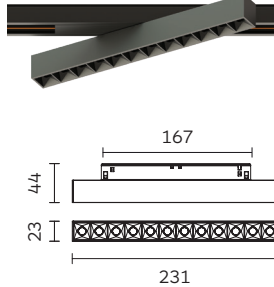

Low Voltage Track with 16 LEDs

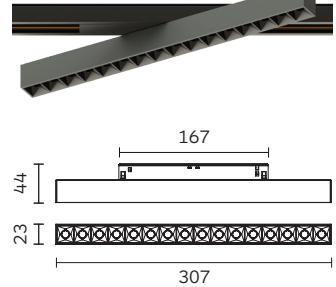

Polaris 20 Wallwasher Low Voltage

Low Voltage Track with 3 LEDs

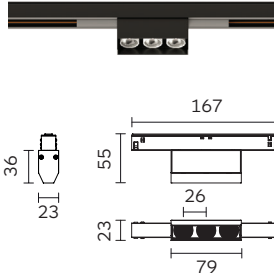

Low Voltage Track with 6 LEDs

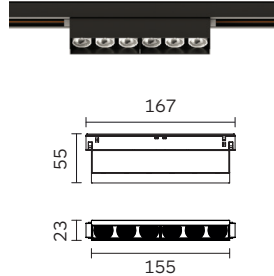

Low Voltage Track with 9 LEDs

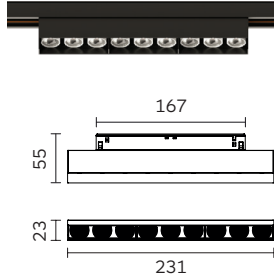

Low Voltage Track with 12 LEDs

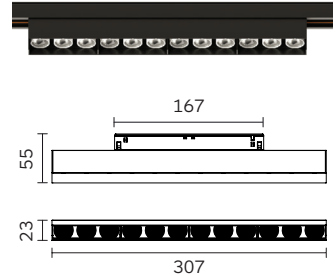

Code ordering example: 9 6 0 1 B O 1 1 - 9 0 3 0 2 1 D 0 1 0

	Product Code	Light Source Code*	>CRI	CCT**	LED Power	Nominal Lumen	Beam Angle (BA°)	Driver Options	Finish
Polaris 20 Low Voltage with 4 LEDs	9601	BO11 High Power LED	90	30 3000K	4x1W	520 lm	21 / 33 / 45 / 60	D0 No Dim	10 ■ Black
				40 4000K		600 lm		DA Dali Dim	11 □ White
Polaris 20 Low Voltage with 8 LEDs	9602				8x1W	1040 lm		DC CASAMBI	17 ▣ B/W
						1200 lm		D1 0-10V Dim	
Polaris 20 Low Voltage with 12 LEDs	9603				12x1W	1560 lm			
Polaris 20 Low Voltage with 16 LEDs	9604				16x1W	2080 lm			
Polaris 20 Wallwasher Low Voltage with 3 LEDs	9626	BN11 High Power LED			3x1W	384 lm	WW		10 ■ Black
								420 lm	11 □ White
Polaris 20 Wallwasher Low Voltage with 6 LEDs	9627				6x1W	768 lm			
Polaris 20 Wallwasher Low Voltage with 9 LEDs	9628				9x1W	1152 lm			
Polaris 20 Wallwasher Low Voltage with 12 LEDs	9629				12x1W	1536 lm			
						1680 lm			

Notes:

- * For complete code ordering information, please see page 51.
 - ** For other CCT options, please contact us.
 - 17**: white light body with black integrated louvre. For black body with white integrated louvre consult us.
 - WW**: Wallwasher
- For the most updated product information, please go to our website.

Polaris Opal Diffuser Low Voltage

Low Voltage Track

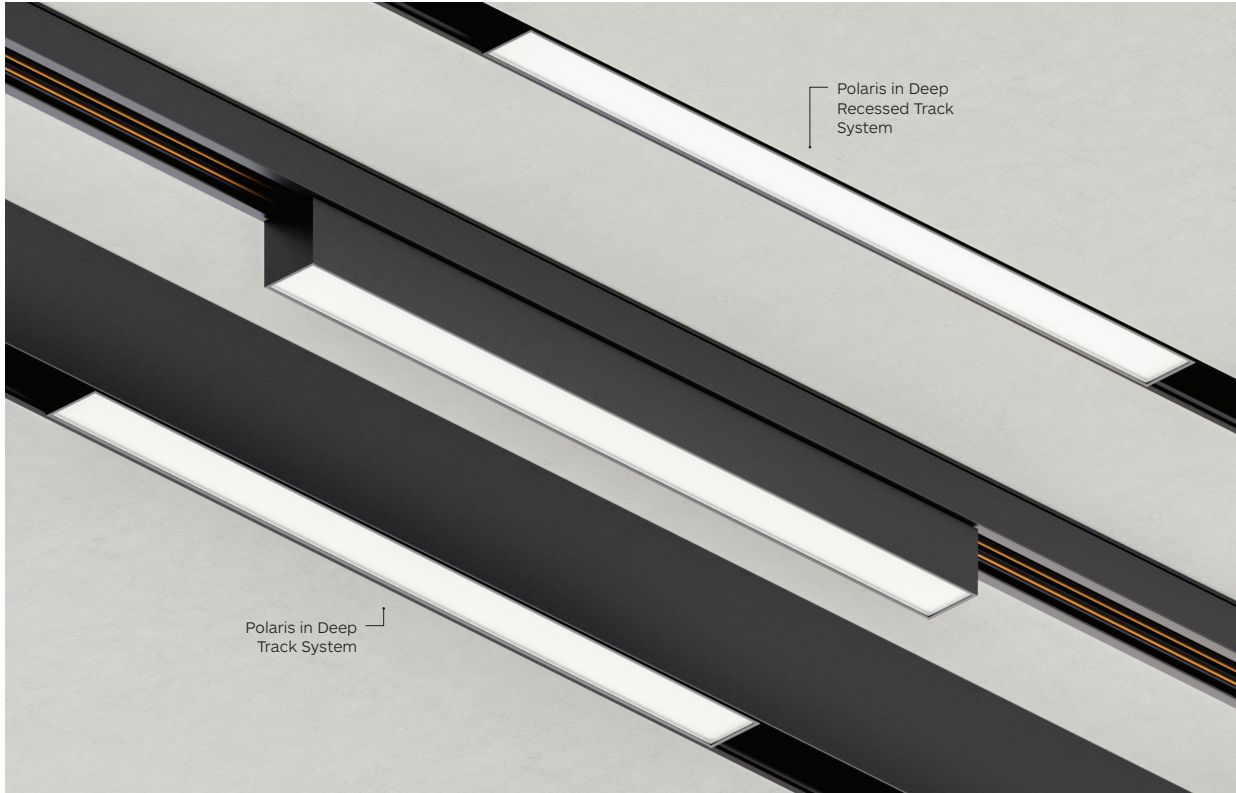

Body

Track mounted 48V low voltage spotlight with light body in extruded aluminium inclusive of white opal diffuser for soft and diffuse illumination.

Integrated track adapter, compatible with different models of Stucchi low voltage track system.

Easy to insert and remove from the track.

Accessories

For more information about low voltage track accessories see page 40-45.

Finish

Powder coat in black or white.

LED sources

Light source options: High Power LED.
CRI: 90 | CCT: 3000K, 4000K.
Other CRI, CCT and Tuneable White options available on request.

Optic

Opal diffuser. Extra wide beam angle.

Driver

Integrated 48V DC input.
Diming Options: 0-10V, DALI, Casambi.
Check page 46 for more details about diming options.
Power supply unit to be ordered separately, see page 46.

Applications

An innovative solution for soft and diffuse illumination. The light source is barely visible, as the diffuser helps to create a morbid and uniform light emission.
Application areas: residential, hotels, restaurants, retail, corridors.

Compatible with Low Voltage Track Types

Please see P.40-41 for details



2ST1
Surface Track



2ST6
Surface Track
Pendant Track



2ST2
Deep Surface Track
Deep Pendant Track



2ST7
Pendant Track
For Down Side



2ST9
Deep Pendant Track
For Down Side



2ST8
Recessed Track
Trim



2ST3
Recessed Track
Trimless



2ST5
Deep Recessed
Track Trimless



2STA
Deep Recessed
Track Trimless

Polaris 20 Opal Diffuser Low Voltage



Polaris 20 Opal Diffuser Low Voltage



Low Voltage Track L: 307

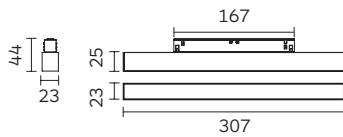

Low Voltage Track L: 611

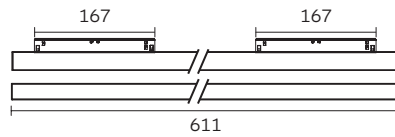

Low Voltage Track L: 915

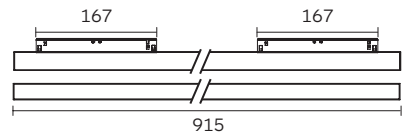

Low Voltage Track L: 1219

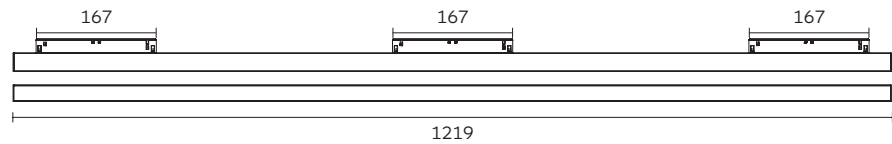

Low Voltage Track L: 1523

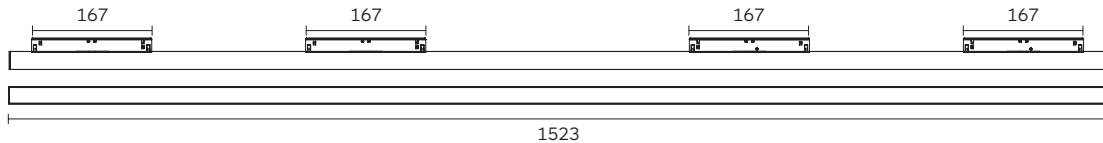

Code ordering example: 9 6 0 5 B 0 1 1 - 9 0 3 0 O D D 0 1 0

	Product Code	Light Source Code*	>CRI	CCT**	LED Power	Nominal Lumen	Beam Angle (BA*)	Driver Options	Finish
Polaris 20 Opal Diffuser Low Voltage L: 307	9605	B011 High Power LED	90	30 3000K	16W	2080 lm	OD Opal Diffuser	D0 No Dim	10 ■ Black
				40 4000K		2400 lm			DA Dali Dim
Polaris 20 Opal Diffuser Low Voltage L: 611	9606				32W	4160 lm		DC CASAMBI	
Polaris 20 Opal Diffuser Low Voltage L: 915	9607				48W	6240 lm			
Polaris 20 Opal Diffuser Low Voltage L: 1219	9608				64W	8320 lm			
Polaris 20 Opal Diffuser Low Voltage L: 1523	9609				80W	10400 lm			

Notes:

* For complete code ordering information, please see page 51.
 ** For other CCT options, please contact us.
 For the most updated product information, please go to our website.

Polaris Extended Arm Low Voltage

Low Voltage Track



Body

Track mounted 48V low voltage spotlight with light body and arm in extruded aluminium inclusive of Integrated diamond faceted no-dazzle screen in thermoplastic.

Integrated track adapter, compatible with different models of Stucchi low voltage track system.

Easy to insert and remove from the track. Versatile aiming angle tiltable vertically 90°.

Available in configurations of multiple of 4 LEDs.

Accessories

For more information about low voltage track accessories see page 40-45.

Finish

Powder coat in black or white. White version available also with integrated black thermoplastic screen.

LED sources

Light source options: High Power LED.

CRI: 90 | CCT: 3000K, 4000K.

Other CRI, CCT and Tuneable White options available on request.

Optic

Lens plus thermoplastic screen.

UGR < 16.

Four different beam angles available.

Driver

Integrated 48V DC input.

Diming Options: 0-10V, DALI, Casambi.

Check page 46 for more details about diming options.

Power supply unit to be ordered separately, see page 46.

Applications

An innovative solution to illuminate object on a wall. A modern alternative to the traditional picture lights.

Application areas: residential, hotels, restaurants, retail, corridors.

Compatible with Low Voltage Track Types

Please see P.40-41 for details



2ST1

Surface Track



2ST6

Surface Track
Pendant Track



2ST2

Deep Surface Track
Deep Pendant Track



2ST7

Pendant Track
For Up & Down



2ST9

Deep Pendant Track
For Up & Down



2ST8

Recessed Track
Trim



2ST3

Recessed Track
Trimless



2ST5

Deep Recessed
Track Trimless



2STA

Deep Recessed
Track Trimless

Polaris 20 Extended Arm Low Voltage



Polaris 20 Extended Arm

Low Voltage Track with 4 LEDs

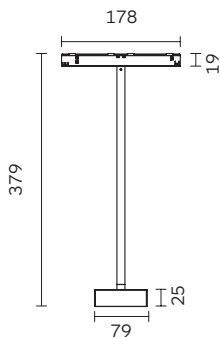

Low Voltage Track with 8 LEDs

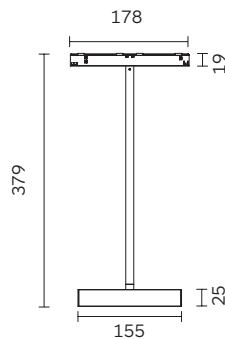

Low Voltage Track with 12 LEDs

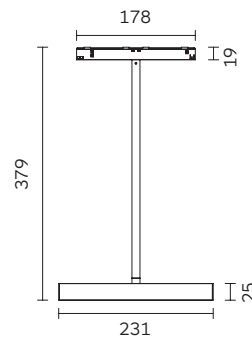

Low Voltage Track with 16 LEDs

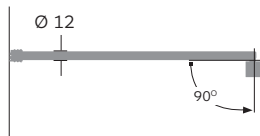
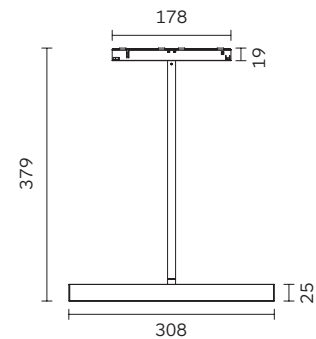

Code ordering example: **9 6 1 0 B 0 1 1 - 9 0 3 0 2 1 D 0 1 0**

	Product Code	Light Source Code*	>CRI	CCT**	LED Power	Nominal Lumen	Beam Angle (BA°)	Driver Options	Finish
Polaris 20 Extended Arm Low Voltage with 4 LEDs	9610	B011 High Power LED	90	30 3000K	4x1W	520 lm	21 / 33 / 45 / 60	D0 No Dim	10 ■ Black
				40 4000K		600 lm		DA Dali Dim	11 □ White
Polaris 20 Extended Arm Low Voltage with 8 LEDs	9611				8x1W	1040 lm		DC CASAMBI	17 ▣ B/W
						1200 lm		D1 0-10V Dim	
Polaris 20 Extended Arm Low Voltage with 12 LEDs	9612				12x1W	1560 lm			
Polaris 20 Extended Arm Low Voltage with 16 LEDs	9613				16x1W	2080 lm			
						2400 lm			

Notes:

* For complete code ordering information, please see page 51.

** For other CCT options, please contact us.

17: white light body with black integrated louvre. For black body with white integrated louvre consult us.

For the most updated product information, please go to our website.

Zero Low Voltage

Low Voltage Track



Body

Track mounted 48V low voltagespotlight with lighthouse and arm in aluminium.

Integrated track adapter, compatible with different models of Stucchi low voltage track system.

Easy to insert and remove from the track. Designed for passive cooling.

Available in three different sizes (40, 66, 100).

Versatile aiming angle tiltable vertically 0°-90° and rotatable horizontally 360°.

Accessories

Colored filters, linear spread, honeycomb louvre, visor, anti-glare tube.
For more information about low voltage track accessories see page 40-45.

Finish

Powder coat in black or white colour.

LED sources

Light source options: COB LED, High Power LED.
CRI: 90 | CCT: 3000K, 4000K, Tuneable White.
Other CRI and CCT options available on request.

Optic

Lens.
Super narrow (7°), narrow, medium and wide beam angle available.

Driver

Integrated 48V DC input.
Diming Options: 0-10V, DALI, Casambi.
Check page 46 for more details about diming options.
Power supply unit to be ordered separately, see page 46.

Applications

A modern design consisting for the purpose to meet the highest requirements of the latest advanced lighting technology.
Application areas: retail, museums, hospitality, residential, offices, lobbies.

Compatible with Low Voltage Track Types

Please see P.40-41 for details



2ST1
Surface Track



2ST6
Surface Track
Pendant Track



2ST7
Pendant Track
For Up & Down



2ST9
Deep Pendant Track
For Up Side



2ST8
Recessed Track
Trim



2ST3
Recessed Track
Trimless

Zero Low Voltage

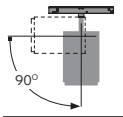

Zero 40 Low Voltage

Low Voltage Track

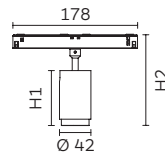

Light Source code	H1 in mm	H2 in mm
BR21	73	121
BC31	73	121
BU11	102	150

Zero 66 Low Voltage

Low Voltage Track

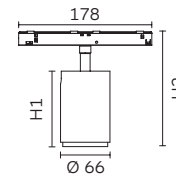

Light Source code	H1 in mm	H2 in mm
BR21	101	150
BC22	101	150
IU21	101	150
GU53	118	168

Zero 100 Low Voltage

Low Voltage Track

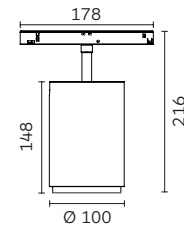

Code ordering example: 9 6 1 4 B R 2 1 - 9 0 3 0 0 7 D 0 1 0

	Product Code	Light Source Code*	>CRI	CCT**	LED Power	Nominal Lumen	Beam Angle (BA°)	Driver Options	Finish
Zero 40 Low Voltage	9614	BR21 High Power LED	90	30 3000K	4W	400 lm	07 / 24 / 36	D0 No Dim	10 ■ Black
				40 4000K		430 lm		DA Dali Dim	11 □ White
		BC31 COB LED	90		6W	630 lm	16 / 26 / 36	DC CASAMBI	
						650 lm		D1 0-10V Dim	
Zero 66 Low Voltage	9615	BR21 High Power LED	30	3000K	6W	530 lm	05		
				40 4000K		580 lm			
		BC22 COB LED	90		12W	1550 lm	16 / 25 / 36		
						1570 lm			
Zero 100 Low Voltage	9616	BR21 4xHigh Power LED	90	30 3000K	21W	1862 lm	07 / 24 / 36		
				40 4000K		1920 lm			
Zero 100 Low Voltage	9616	BC33 COB LED	90		21W	2280 lm	15 / 23 / 36		
						2490 lm			
Zero 100 Low Voltage	9616	IU31 TW COB LED	90	TW 2700K-6500K	19W	1900 lm	20 / 29 / 41		

Optical Accessories

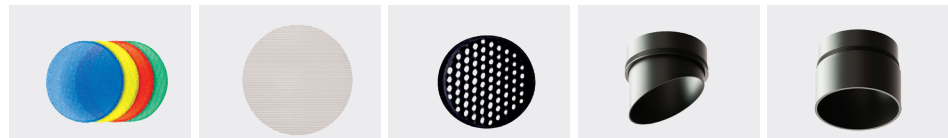

Product / Optical Accessories	Coloured Filters Colours 25, 42, 55, 85	Linear Spread Colour 41	Honeycomb Louvre Colour 10	Visor Colours 10, 17	Anti-glare Tube Colours 10, 17
Zero 66 Low Voltage	2D63*	2D62*	2C65	2D94	2D67
Zero 100 Low Voltage	2E10*	2E12*	2C66	2E14	2E16

* With holder

Notes:

* For complete code ordering information, please see page 51.

** For other CCT options, please contact us.

For the most updated product information, please go to our website.

Zero Low Voltage

Long Arm for Low Voltage Track



Body

Zero with long arm is track mounted 48V low voltage spotlight with lighthead and arm in aluminium.

Integrated track adapter, compatible with different models of Stucchi low voltage deep track system.

Easy to insert and remove from the track. Designed for passive cooling.

Available in three different sizes (40, 66, 100).

Versatile aiming angle tiltable vertically 0°-90° and rotatable horizontally 360°.

Accessories

Colored filters, linear spread, honeycomb louvre, visor, anti-glare tube.
For more information about low voltage track accessories see page 40-45.

Finish

Powder coat in black or white colour.

LED sources

Light source options: COB LED. High Power LED.
CRI: 90 | CCT: 3000K, 4000K, Tuneable White.
Other CRI and CCT options available on request.

Optic

Lens.
Super narrow (7°), narrow, medium and wide beam angle available.

Driver

Integrated 48V DC input.
Diming Options: 0-10V, DALI, Casambi.
Check page 46 for more details about diming options.
Power supply unit to be ordered separately, see page 46.

Applications

A modern design consisting for the purpose to meet the highest requirements of the latest advanced lighting technology.

Application areas: retail, museums, hospitality, residential, offices, lobbies.

Compatible with Low Voltage Track Types

Please see P.40-41 for details



2ST2
Deep Surface Track
Deep Pendant Track



2ST9
Deep Pendant Track
For Up & Down



2ST5
Deep Recessed
Track Trimless



2STA
Deep Recessed
Track Trimless

Zero Low Voltage

Long Arm



Zero 40 Low Voltage

With Long Arm for Low Voltage Track

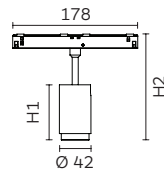

Light Source code	H1 in mm	H2 in mm
BR21	73	142
BC31	73	142
BU11	102	171

Zero 66 Low Voltage

With Long Arm for Low Voltage Track

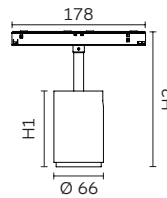

Light Source code	H1 in mm	H2 in mm
BR21	101	180
BC22	101	180
IU21	101	180
GU53	118	198

Zero 100 Low Voltage

With Long Arm for Low Voltage Track

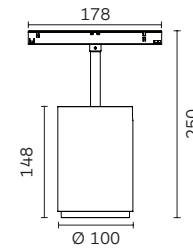

Code ordering example: **9 6 3 1 B R 2 1 - 9 0 3 0 0 7 D 0 1 0**

	Product Code	Light Source Code*	>CRI	CCT**	LED Power	Nominal Lumen	Beam Angle (BA°)	Driver Options	Finish	
Zero 40 Low Voltage with Long Arm	9631	BR21 High Power LED	90	30 3000K	4W	400 lm	07 / 24 / 36	D0 No Dim	10 ■ Black	
				40 4000K		430 lm		DA Dali Dim	11 □ White	
		BC31 COB LED	90		6W	630 lm	16 / 26 / 36	DC CASAMBI		
						650 lm		D1 0-10V Dim		
Zero 66 Low Voltage with Long Arm	9632	BR21 High Power LED	30	3000K	6W	530 lm	05			
				40 4000K		580 lm				
		BC22 COB LED	90		12W	1550 lm	16 / 25 / 36			
						1570 lm				
IU21 TW COB LED	90		TW 2700K-6500K	13W	1290 lm	16 / 25 / 48				
Zero 100 Low Voltage with Long Arm	9634	BR21 4xHigh Power LED	90	30 3000K	21W	1862 lm	07 / 24 / 36			
				40 4000K		1920 lm				
		BC33 COB LED	90			21W	2280 lm	15 / 23 / 36		
						2490 lm				
IU31 TW COB LED	90	TW 2700K-6500K	19W	1900 lm	20 / 29 / 41					

Optical Accessories

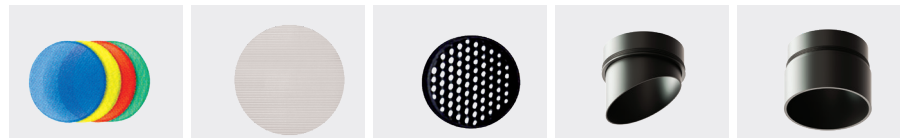

Product / Optical Accessories	Coloured Filters Colours 25, 42, 55, 85	Linear Spread Colour 41	Honeycomb Louvre Colour 10	Visor Colours 10, 17	Anti-glare Tube Colours 10, 17
Zero 66 Low Voltage with Long Arm	2D63*	2D62*	2C65	2D94	2D67
Zero 100 Low Voltage with Long Arm	2E10*	2E12*	2C66	2E14	2E16

* With holder

Notes:

* For complete code ordering information, please see page 51.
 ** For other CCT options, please contact us.
 For the most updated product information, please go to our website.

Zero Zoom Low Voltage

Low Voltage Track



Body

Track mounted 48V low voltagespotlight with lighthouse and arm in cast aluminium.

Integrated track adapter, compatible with different models of Stucchi low voltage track system.

Easy to insert and remove from the track. Beam Angle manually adjustable through ring rotation, from 10° to 35°.

Designed for passive cooling.

Versatile aiming angle tiltable vertically 0°-90° and rotatable horizontally 360°.

Accessories

For more information about low voltage track accessories see page 40-45.

Finish

Powder coat in black or white colour.

LED sources

Light source options: COB LED.
CRI: 90 | CCT: 3000K, 4000K.
Other CRI and CCT options available on request.

Optic

Lens.
Adjustable beam angle (10-35°)

Driver

Integrated 48V DC input.
Dimming Options: 0-10V, DALI, Casambi.
Check page 46 for more details about dimming options.
Power supply unit to be ordered separately, see page 46.

Applications

A modern design consisting for the purpose to meet the highest requirements of the latest advanced lighting technology.

Application areas: retail, museums, hospitality, residential, offices, lobbies.

Compatible with Low Voltage Track Types

Please see P.40-41 for details



2ST1
Surface Track



2ST6
Surface Track
Pendant Track



2ST2 (For 9633)
Deep Surface Track
Deep Pendant Track



2ST7
Pendant Track
For Down Side



2ST9
Deep Pendant Track
For Down Side (9617)
For Up & Down (9633)



2ST8
Recessed Track
Trim



2ST3
Recessed Track
Trimless



2ST5 (For 9633)
Deep Recessed Track
Trimless



2STA (For 9633)
Deep Recessed Track
Trimless

Zero Zoom 80 Low Voltage



Zero Zoom 80 Low Voltage

Low Voltage Track

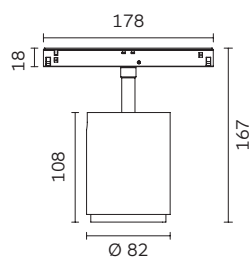

Zero Zoom 80 Low Voltage

With Long Arm for Low Voltage Track

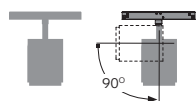
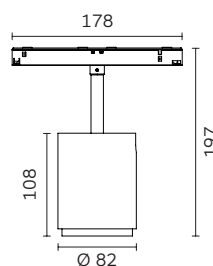

Zoom Spotlights

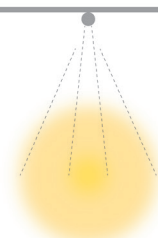

Zoom Spot 10° - 35°

Code ordering example: **9 6 1 7 B C 3 1 - 9 0 3 0 B S D 0 1 0**

	Product Code	Light Source Code*	>CRI	CCT**	LED Power	Nominal Lumen	Beam Angle (BA°)	Driver Options	Finish
Zero Zoom 80 Low Voltage	9617	BC31	90	30 3000K	11W	1160 lm	BS (10-35°)	D0 No Dim	10 ■ Black
				40 4000K		1260 lm		DA Dali Dim	11 □ White
Zero Zoom 80 Low Voltage with Long Arm	9633							DC CASAMBI	
								D1 0-10V Dim	

Notes:

* For complete code ordering information, please see page 51.

** For other CCT options, please contact us.

For the most updated product information, please go to our website.

BS: Beam shaping, Beam Angle: 10-35°, 35° field angle.

Ola Low Voltage

Low Voltage Track



Body

Track mounted 48V low voltage spotlight with lighthouse and arm in cast aluminium. Integrated track adapter, compatible with different models of Stucchi low voltage track system.

Easy to insert and remove from the track. Lighthouse designed for passive cooling.

Available in three different sizes.

Versatile aiming angle tiltable vertically 0°-90° in two directions and rotatable horizontally 360°.

Accessories

For more information about low voltage track accessories see page 40-45.

Finish

Powder coat in black or white colour.

LED sources

Light source options: COB LED. High Power LED.
CRI: 90 | CCT: 3000K, 4000K.
Other CRI and CCT options available on request.

Optic

Lens.
Super narrow (7°), narrow, medium, wide and wallwasher beam angle available.

Driver

Integrated 48V DC input.
Dimming Options: 0-10V, DALI, Casambi.
Check page 46 for more details about dimming options.
Power supply unit to be ordered separately, see page 46.

Applications

A chic and alluring light fixture, designed by formalighting's passionate engineers. His circular shaped classic design easily integrated into various architectural environments.
Application areas: retail, museums, residential, restaurants.

Compatible with Low Voltage Track Types

Please see P.40-41 for details



2ST1
Surface Track



2ST6
Surface Track
Pendant Track



2ST7
Pendant Track
For Down Side



2ST8
Recessed Track
Trim



2ST3
Recessed Track
Trimless

Ola Low Voltage



Ola 55 Low Voltage

Low Voltage Track

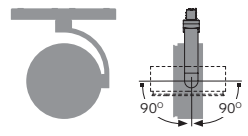
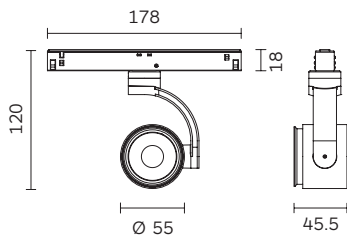

Ola 100 Low Voltage

Low Voltage Track

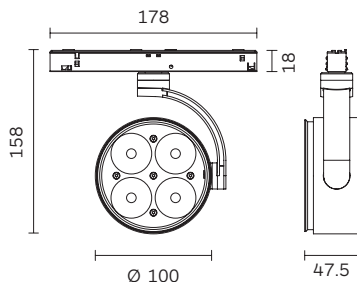

Ola 130 Low Voltage

Low Voltage Track

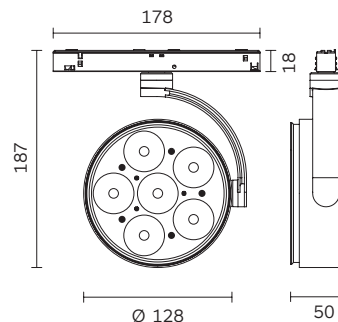

Code ordering example: 9 6 1 8 B C 2 2 - 9 0 3 0 1 8 D 0 1 0

	Product Code	Light Source Code*	Light Source	>CRI	CCT**	LED Power	Nominal Lumen	Beam Angle (BA°)	Driver Options	Finish
Ola 55 Low Voltage Track	9618	BC22	COB LED	90	30 3000K	9W	1140 lm	18 / 24 / 36	D0 No Dim	10 ■ Black
					40 4000K		1270 lm	DA Dali Dim	11 □ White	
					BR21 High Power LED		4W	400 lm	07	DC CASAMBI
Ola 100 Low Voltage Track	9619	BC33	COB LED			17W	1934 lm	15 / 24 / 38		
							2041 lm			
				BR21 4xHigh Power LED		16W	1760 lm	07 / 24 / 36		
Ola 130 Low Voltage Track	9620	BC33	COB LED			25W	2760 lm	12 / 22 / 32		
							3000 lm			
				BR11 12x Mid Power LED		24W	2550 lm	10 / 23 / 46 / WW		
							2730 lm			
						20W	2320 lm	07 / 24 / 36		
							2560 lm			

Notes:

* For complete code ordering information, please see page 51.

** For other CCT options, please contact us.

WW: Wallwasher

For the most updated product information, please go to our website.

Ola Zoom Low Voltage

Low Voltage Track



Body

Track mounted 48V low voltage spotlight with lighthouse and arm in cast aluminium.

Integrated track adapter, compatible with different models of Stucchi low voltage track system.

Easy to insert and remove from the track. Lighthouse designed for passive cooling. Beam Angle manually adjustable through ring rotation, from 10° to 35°.

Versatile aiming angle tiltable vertically 0°-90° in two directions and rotatable horizontally 360°.

Accessories

For more information about low voltage track accessories see page 40-45.

Finish

Powder coat in black or white colour.

LED sources

Light source options: COB LED.
CRI: 90 | CCT: 3000K, 4000K.
Other CRI and CCT options available on request.

Optic

Lens.
Adjustable beam angle (10-35°)

Driver

Integrated 48V DC input.
Dimming Options: 0-10V, DALI, Casambi.
Check page 46 for more details about dimming options.
Power supply unit to be ordered separately, see page 46.

Applications

A chic and alluring light fixture, designed by formalighting's passionate engineers. His circular shaped classic design easily integrated into various architectural environments.
Application areas: retail, museums, residential, restaurants.

Compatible with Low Voltage Track Types

Please see P.40-41 for details



2ST1
Surface Track



2ST6
Surface Track
Pendant Track



2ST7
Pendant Track
For Down Side



2ST8
Recessed Track
Trim

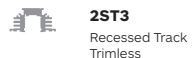

2ST3
Recessed Track
Trimless

Ola Zoom 100 Low Voltage



Ola Zoom 100 Low Voltage

Low Voltage Track

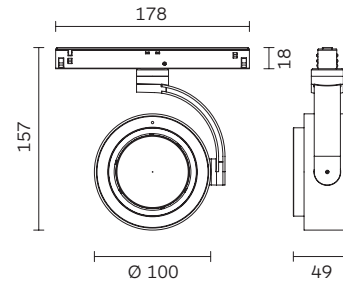

Zoom Spotlights

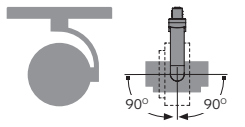
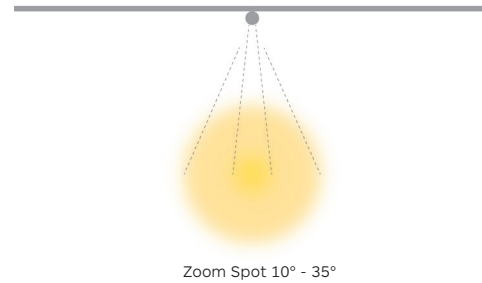

Code ordering example: **9 6 2 1 B C 3 1 - 9 0 3 0 B S D 0 1 0**

	Product Code	Light Source Code*	>CRI	CCT**	LED Power	Nominal Lumen	Beam Angle (BA°)	Driver Options	Finish
Ola Zoom 100 Low Voltage	9621	BC31 COB LED	90	30 3000K	11W	1160 lm	BS (10-35°)	D0 No Dim	10 ■ Black
				40 4000K		1260 lm		DA Dali Dim	11 □ White
								DC CASAMBI	
								D1 0-10V Dim	

Notes:

* For complete code ordering information, please see page 51.
 ** For other CCT options, please contact us.
 For the most updated product information, please go to our website.
BS: Beam shaping, Beam Angle: 10-35°, 35° field angle.

Rolo & Dado Low Voltage

Low Voltage Track

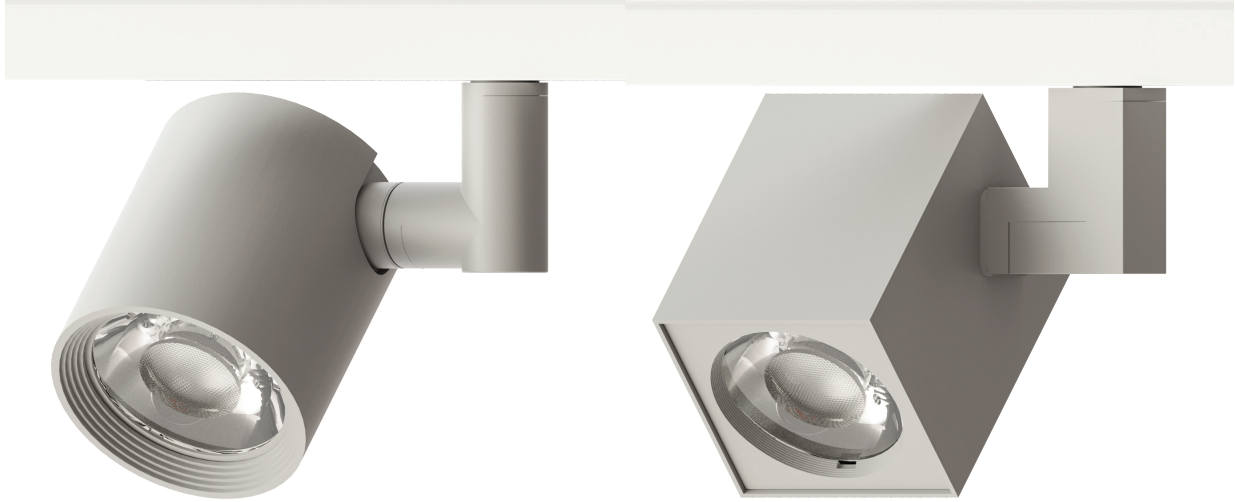

Body

Track mounted 48V low voltage spotlights with light-head and arm in cast aluminium.

Integrated track adapter, compatible with different models of Stucchi low voltage track system.

Easy to insert and remove from the track.

Versatile aiming angle tiltable vertically 0°-90° in two directions and rotatable horizontally 360°.

Accessories

For more information about low voltage track accessories see page 40-45.

Finish

Powder coat in black, white or grey colour.

LED sources

Light source options: COB LED. High Power LED.

CRI: 90 | CCT: 3000K, 4000K.

Other CRI and CCT options available on request.

Optic

Lens.

Narrow, medium and wide beam angle available.

Driver

Integrated 48V DC input.

Diming Options: 0-10V, DALI, Casambi.

Check page 46 for more details about diming options.

Power supply unit to be ordered separately, see page 46.

Applications

A versatile and very directional tiny spotlight. The very compact sizes make it ideal for applications where the distance between ceiling and spot is an issue.

Application areas: retail, museums, residential, hospitality, window displays.

Compatible with Low Voltage Track Types

Please see P.40-41 for details



2ST1
Surface Track



2ST6
Surface Track
Pendant Track



2ST7
Pendant Track
For Down Side



2ST8
Recessed Track
Trim



2ST3
Recessed Track
Trimless

Rolo Low Voltage & Dado Low Voltage



Rolo Low Voltage

Low Voltage Track

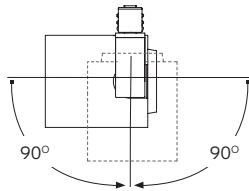
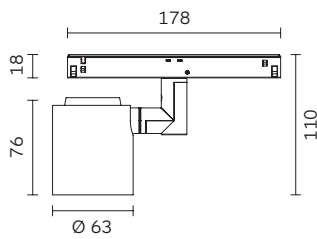

Dado Low Voltage

Low Voltage Track

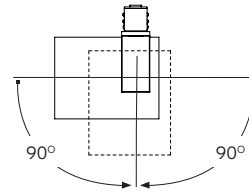
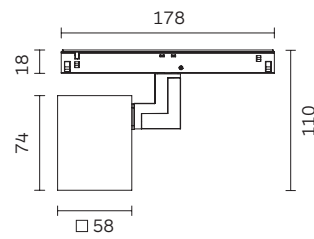
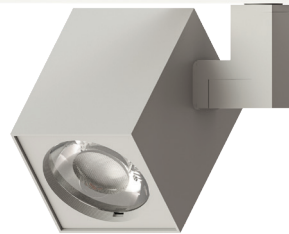

Code ordering example: **9 6 2 4 B R 2 1 - 9 0 3 0 0 7 D 0 1 0**

	Product Code	Light Source Code*	>CRI	CCT**	LED Power	Nominal Lumen	Beam Angle (BA°)	Driver Options	Finish
Rolo Low Voltage	9624	BR21 High Power LED	90	30 3000K	4W	400lm	07	D0 No Dim	10 ■ Black
Dado Low Voltage	9625	BC31 COB LED		40 4000K		430lm		DA Dali Dim	11 □ White
					11W	1080lm	11 / 16 / 32	DC CASAMBI	75 ■ Grey
						1180lm		D1 0-10V Dim	
	GU53^{#1}	Retrofit MR16-GU5.3	00	00	/	/	00		

Notes:

* For complete code ordering information, please see page 51.

** For other CCT options, please contact us.

#1 GU5.3 Retrofit LED bulb not included, max power 12W.

For the most updated product information, please go to our website.

Conos Low Voltage

Low Voltage Track



Body

Track mounted 48V low voltage spotlight with light-head and arm in cast aluminium.

Integrated track adapter, compatible with different models of Stucchi low voltage track system.

Easy to insert and remove from the track. Equipped with super pure aluminium reflector.

Versatile aiming angle tiltable vertically 0°-90° and rotatable horizontally 360°.

Accessories

Honeycomb louvre.
For more information about low voltage track accessories see page 40-45.

Finish

Powder coat in black, white or grey colour.

LED sources

Light source options: COB LED.
CRI: 90 | CCT: 3000K, 4000K.
Other CRI and CCT options available on request.

Optic

Lens.
Narrow, medium and wide beam angle available.

Driver

Integrated 48V DC input.
Diming Options: 0-10V, DALI, Casambi.
Check page 46 for more details about diming options.
Power supply unit to be ordered separately, see page 46.

Applications

A concept in spotlight design with continuous line applications for the benefit of increasing the possibility of display lighting. ideal fitting to illuminate small spaces.
Application areas: retail, museums, residential, hospitality, window displays.

Compatible with Low Voltage Track Types

Please see P.40-41 for details



2ST1
Surface Track



2ST6
Surface Track
Pendant Track



2ST2
Deep Surface Track
Deep Pendant Track



2ST7
Pendant Track
For Up & Down



2ST9
Deep Pendant Track
For Up & Down



2ST8
Recessed Track
Trim



2ST3
Recessed Track
Trimless



2ST5
Deep Recessed
Track Trimless



2STA
Deep Recessed
Track Trimless

Conos 68 Low Voltage

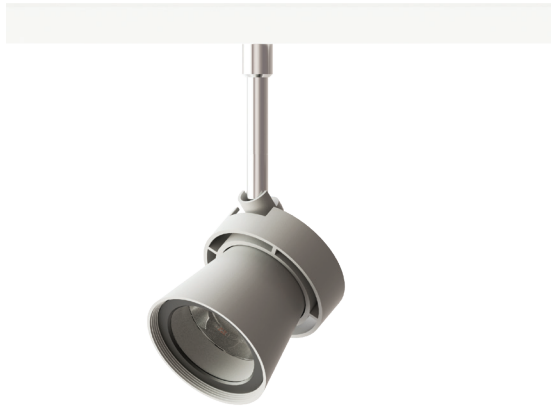

Conos 68 Low Voltage
Low Voltage Track

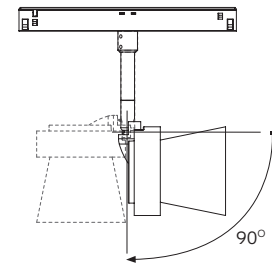
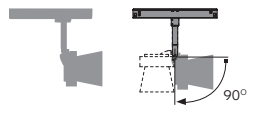
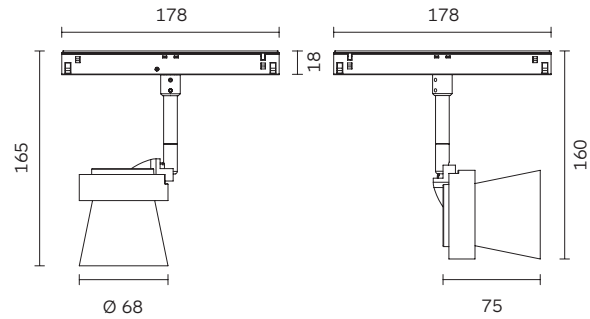

Code ordering example: 9 6 2 3 B C 3 1 - 9 0 3 0 1 1 D 0 1 0

	Product Code	Light Source Code*	>CRI	CCT	LED Power	Nominal Lumen	Beam Angle (BA°)	Driver Options	Finish
Conos 68 Low Voltage	9623	BC31 COB LED	90	30 3000K	11W	1080 lm	11 / 16 / 32	D0 No Dim	10 ■ Black
				40 4000K		1180 lm		DA Dali Dim	11 □ White
	GU53 ^{#1} Retrofit MR16-GU5.3	00	00	/	/	00	DC CASAMBI	75 ■ Grey	
								D1 0-10V Dim	

Optical Accessories

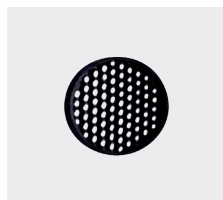

Product / Optical Accessories

Honeycomb Louvre
Colour 10

Conos 68 Low Voltage Track

2B95

With holder

Notes:

* For complete code ordering information, please see page 51.

** For other CCT options, please contact us.

^{#1} GU5.3 Retrofit LED bulb not included, max power 12W.

For the most updated product information, please go to our website.

Polaris Low Voltage

Low Voltage Track Pendant

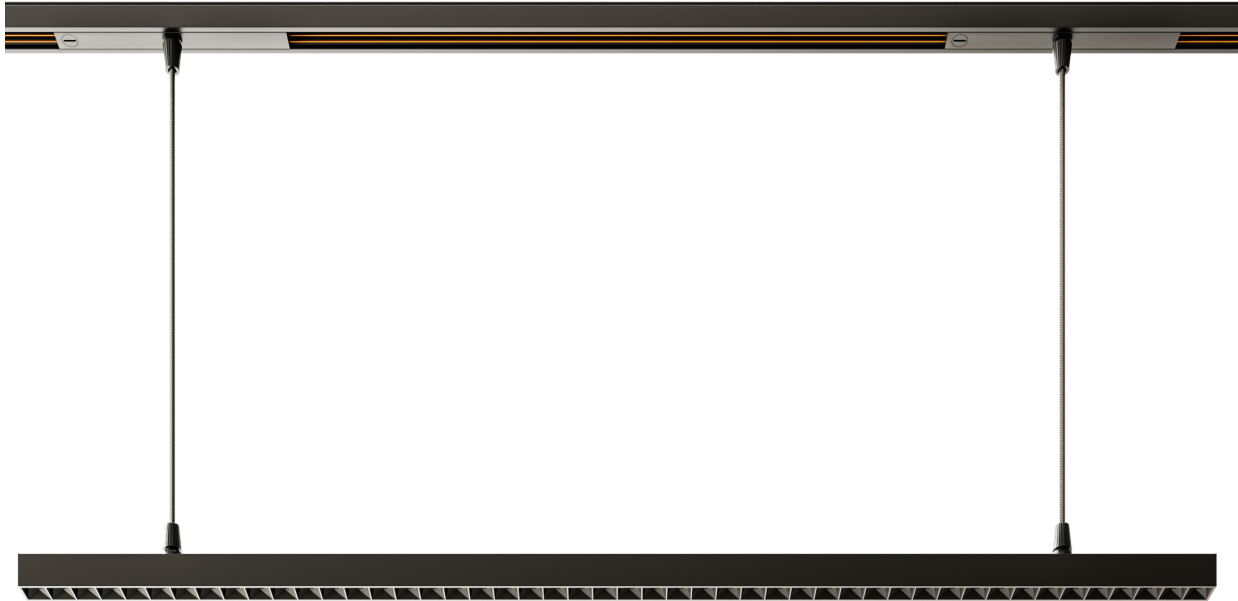

Body

Pendant luminaire for 48V low voltage track systems with light body in extruded aluminium inclusive of integrated diamond faceted no-dazzle screen in thermoplastic.

Supplied with integrated track adapter, compatible with different models of Stucchi low voltage track system, and 2 x 1.5m pendant wires.

Easy to insert and remove from the track.

Available in configurations of multiple of 4.

Accessories

For more information about low voltage track accessories see page 40-45.

Finish

Powder coat in black or white. White version available also with integrated black thermoplastic screen.

LED sources

Light source options: High Power LED.

CRI: 90 | CCT: 3000K, 4000K.

Other CRI, CCT and Tuneable White options available on request.

Optic

Lens plus thermoplastic screen.

UGR < 16.

Four different beam angles available.

Driver

Integrated 48V DC input.

Diming Options: 0-10V, DALI, Casambi.

Check page 46 for more details about diming options.

Power supply unit to be ordered separately, see page 46.

Applications

An innovative solution for high brilliance and performance.

The light source is barely visible, as the miniature light heads create a high contrast and linear light emission.

Application areas: residential, hotels, restaurants, retail, corridors.

Compatible with Low Voltage Track Types

Please see P.40-41 for details



2ST1
Surface Track



2ST6
Surface Track
Pendant Track



2ST2
Deep Surface Track
Deep Pendant Track



2ST7
Pendant Track
For Down Side



2ST9
Deep Pendant Track
For Down Side



2ST8
Recessed Track
Trim



2ST3
Recessed Track
Trimless



2ST5
Recessed Track
Trimless



2ST4
Deep Recessed
Track Trimless



2ST0
Deep Recessed
Track Trimless



2ST2
Deep Recessed
Track Trimless

Polaris 20 Low Voltage Pendant



Polaris 20

Low Voltage Track Pendant with 36 LEDs

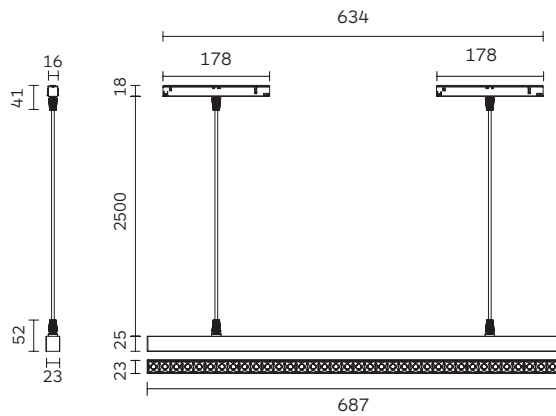

Low Voltage Track Pendant with 48 LEDs

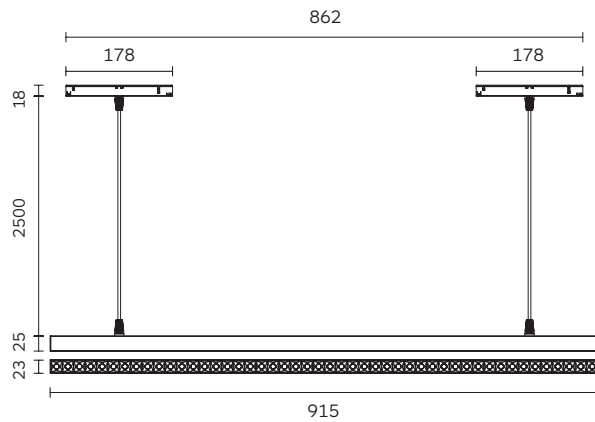

Code ordering example: **9 7 1 2 B O 1 1 - 9 0 3 0 2 1 D 0 1 0**

	Product Code	Light Source Code*	>CRI	CCT**	LED Power	Nominal Lumen	Beam Angle (BA°)	Driver Options	Finish
Polaris 20 Low Voltage Pendant with 36 LEDs	9712	BO11 High Power LED	90	30 3000K	36x1W	4680 lm	21 / 33 / 45 / 60	D0 No Dim	10 ■ Black
				40 4000K		5400 lm		DA Dali Dim	11 □ White
Polaris 20 Low Voltage Pendant with 48 LEDs	9713				48x1W	6240 lm		DC CASAMBI	17 ▣ B/W
						7200 lm		D1 0-10V Dim	

Notes:

- * For complete code ordering information, please see page 51.
 - ** For other CCT options, please contact us.
 - 17:** white light body with black integrated louvre. For black body with white integrated louvre consult us.
- For the most updated product information, please go to our website.

Polaris Opal Diffuser Low Voltage

Low Voltage Track Pendant

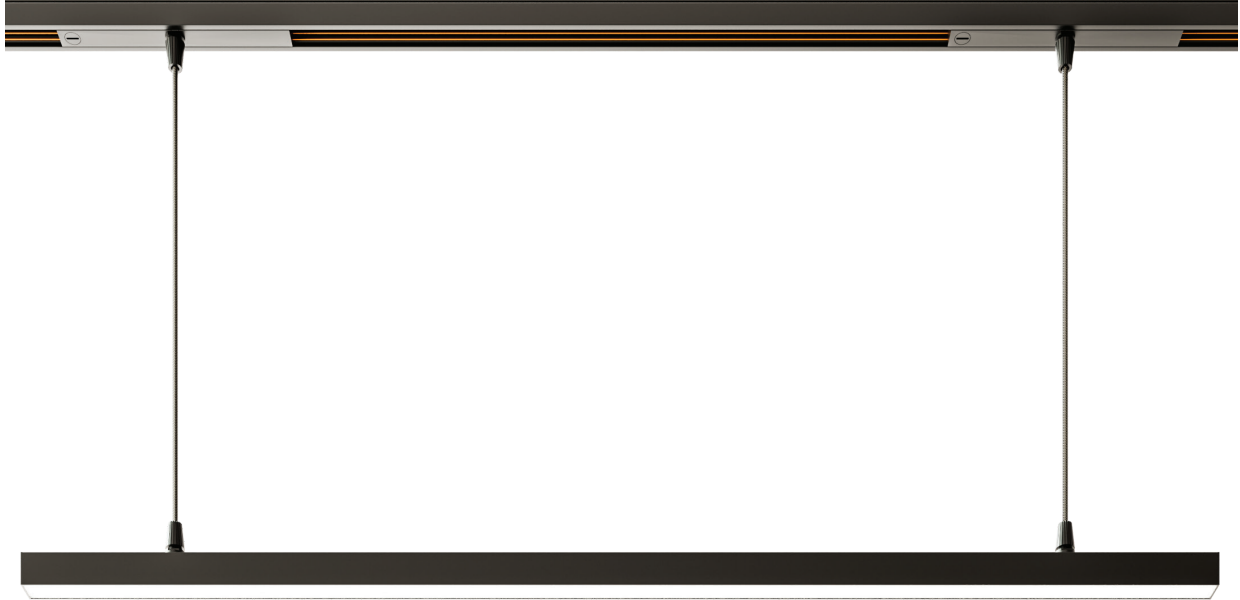

Body

Pendant luminaire for 48V low voltage track systems with light body in extruded aluminium inclusive of white opal diffuser for soft and diffuse illumination.

Supplied with integrated track adapter, compatible with different models of Stucchi low voltage track system, and 2 x 1.5m pendant wires.

Easy to insert and remove from the track.

Accessories

For more information about low voltage track accessories see page 40-45.

Finish

Powder coat in black or white.

LED sources

Light source options: High Power LED.
CRI: 90 | CCT: 3000K, 4000K.

Other CRI, CCT and Tuneable White options available on request.

Optic

Opal diffuser. Extra wide beam angle.

Driver

Integrated 48V DC input.

Diming Options: 0-10V, DALI, Casambi.

Check page 46 for more details about diming options.

Power supply unit to be ordered separately, see page 46.

Applications

An innovative solution for soft and diffuse illumination. The light source is barely visible, as the diffuser helps to create a morbid and uniform light emission.

Application areas: residential, hotels, restaurants, retail, corridors.

Compatible with Low Voltage Track Types

Please see P.40-41 for details



2ST1
Surface Track



2ST6
Surface Track
Pendant Track



2ST2
Deep Surface Track
Deep Pendant Track



2ST7
Pendant Track
For Down Side



2ST9
Deep Pendant Track
For Down Side



2ST8
Recessed Track
Trim



2ST3
Recessed Track
Trimless



2ST5
Deep Recessed
Track Trimless



2STA
Deep Recessed
Track Trimless

Polaris 20 Opal Diffuser Low Voltage Pendant



Polaris 20 Opal Diffuse

Polaris 20 Opal Diffuser

Low Voltage Track Pendant L: 687

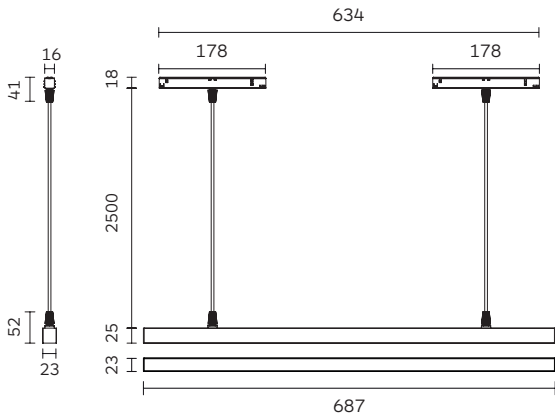

Low Voltage Track Pendant L: 915

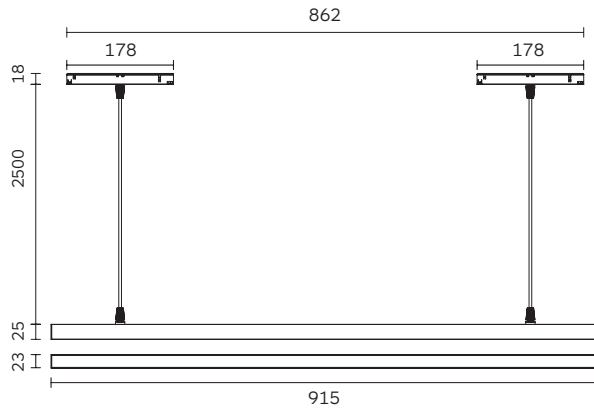

Code ordering example: 9714 B011 - 90 30 00 D0 10

	Product Code	Light Source Code*	>CRI	CCT**	LED Power	Nominal Lumen	Beam Angle (BA°)	Driver Options	Finish
Polaris 20 Opal Diffuser Low Voltage Pendant L: 687	9714	B011 High Power LED	90	30 3000K	36W	4680 lm	00	D0 No Dim	10 ■ Black
				40 4000K		5400 lm		DA Dali Dim	11 □ White
Polaris 20 Opal Diffuser Low Voltage Pendant L: 915	9715	B011 High Power LED			48W	6240 lm		DC CASAMBI	
						7200 lm	D1 0-10V Dim		

Notes:

- * For complete code ordering information, please see page 51.
 - ** For other CCT options, please contact us.
- For the most updated product information, please go to our website.

Pixo

Low Voltage

Low Voltage Track Pendant



Body

Pendant luminaire for 48V voltage track systems with light body in extruded aluminium. Light body available in two diameter (25 and 36mm) and different lengths, to fit any ceiling height .

Exchangable front ring in wide range of colours. Supplied with integrated track adapter, compatible with different models of Stucchi low voltage track system, and 2 x 1.5m pendant wires.

Easy to insert and remove from the track.

Accessories

Decorative ring available in different colours.
Transparent acrylic decorative diffuser.
For more information about low voltage track accessories see page 40-45.

Finish

Powder coat in black or white. Exchangable front ring in different colours.

LED sources

Light source options: High Power LED (Pixo 25). COB LED (Pixo 36).

CRI: 90 | CCT: 3000K, 4000K.

Other CRI and CCT options available on request.

Optic

Lens.

Narrow, medium and wide beam angle available.

Driver

Integrated 48V DC input.

Diming Options: 0-10V, DALI, Casambi.

Check page 46 for more details about diming options.

Power supply unit to be ordered separately, see page 46.

Applications

A modern designed pendant ambient light. Its accessories make it the perfect match for sophisticated enviroments.

Application areas: residential, hotels, restaurants, retail, corridors.

Compatible with Low Voltage Track Types

Please see P.40-41 for details

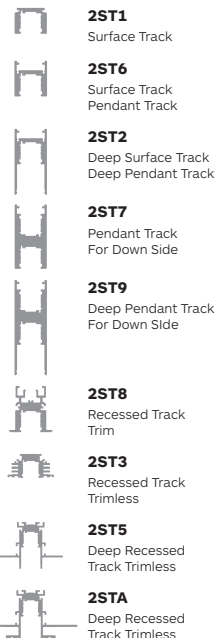

Pixo Low Voltage Pendant

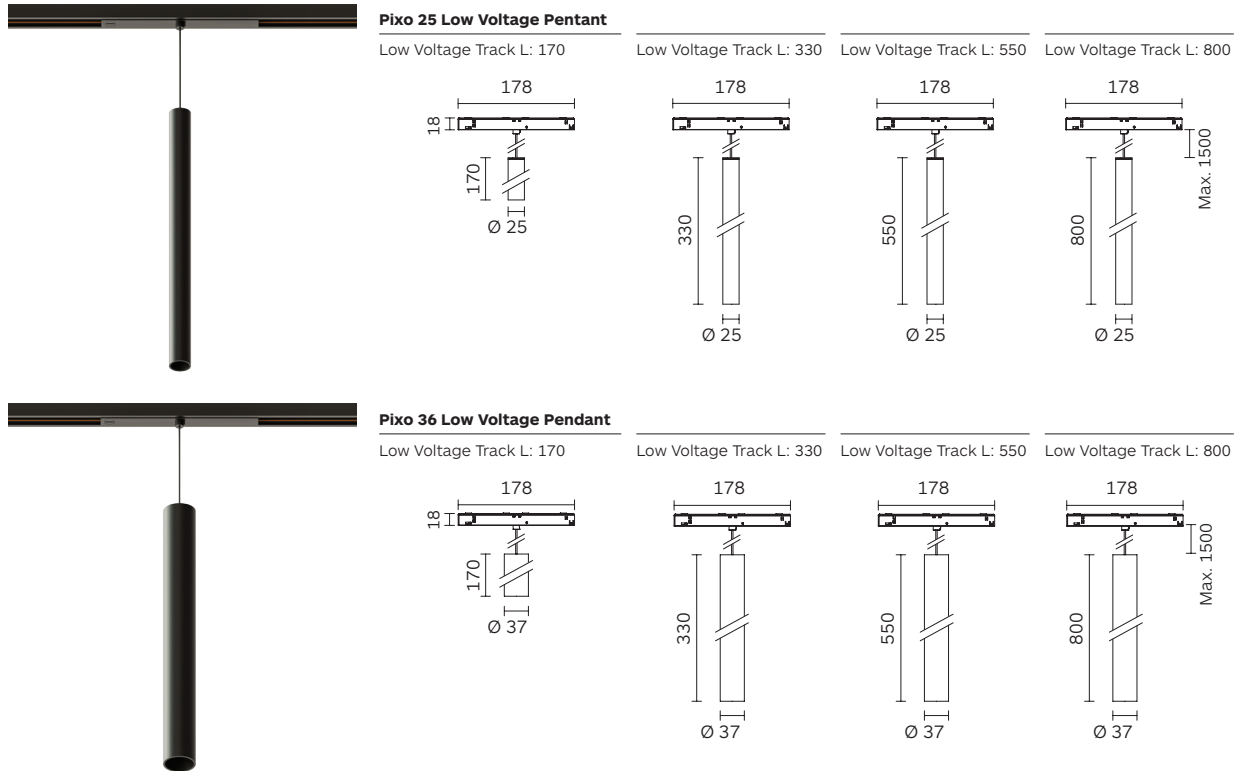

Code ordering example: 9 7 0 3 B N 1 1 - 9 0 3 0 1 4 D 0 1 0

	Product Code	Product Length	Light Source Code*	>CRI	CCT**	LED Power	Nominal Lumen	Beam Angle (BA*)	Driver Options	Finish
Pixo 25 Low Voltage Pendant	9703	170	BN11 High Power LED	90	30 3000K	2W	230 lm	14 / 20 / 26 / 32	D0 No Dim	10 ■ Black
	9704	330			40 4000K	260 lm	DA Dali Dim			
	9705	550				DC CASAMBI				
	9706	800				D1 0-10V Dim				
Pixo 36 Low Voltage Pendant	9707	170	BC31 COB LED			5W	500 lm	20 / 26 / 36		
	9708	330		550 lm						
	9709	550								
	9710	800								

Optical Accessories

Product / Optical Accessories				
Pixo 36 Low Voltage Pendant	2E05	2E07	2E07	2E07

Notes:

* For complete code ordering information, please see page 51.
 ** For other CCT options, please contact us.
 For the most updated product information, please go to our website.

Pixo Zoom Low Voltage

Low Voltage Track Pendant



Body

Pendant luminaire for 48V voltage track systems with light body in extruded aluminium.

Beam angle manually adjustable through ring rotation, from 10° to 35°.

Supplied with integrated track adapter, compatible with different models of Stucchi low voltage track system, and 1.5m pendant wire.

Easy to insert and remove from the track.

Accessories

For more information about low voltage track accessories see page 40-45.

Finish

Powder coat in black or white.

LED sources

Light source options: High Power LED (Pixo 25). COB LED (Pixo 36).

CRI: 90 | CCT: 3000K, 4000K.

Other CRI and CCT options available on request.

Optic

Lens.

Adjustable beam angle (10-35°)

Driver

Integrated 48V DC input.

Dimming Options: 0-10V, DALI, Casambi.

Check page 46 for more details about dimming options.

Power supply unit to be ordered separately, see page 46.

Applications

A modern designed pendant ambient light. Its accessories make it the perfect match for sophisticated environments. The Zoom option adds flexibility in designing the shape of light.

Application areas: residential, hotels, restaurants, retail, corridors.

Compatible with Low Voltage Track Types

Please see P.40-41 for details



2ST1
Surface Track



2ST6
Surface Track
Pendant Track



2ST2
Deep Surface Track
Deep Pendant Track



2ST7
Pendant Track
For Down Side



2ST9
Deep Pendant Track
For Down Side



2ST8
Recessed Track
Trim



2ST3
Recessed Track
Trimless



2ST5
Deep Recessed
Track Trimless



2STA
Deep Recessed
Track Trimless

Pixo Zoom 82 Low Voltage Pendant



Pixo Zoom 82

Low Voltage Track

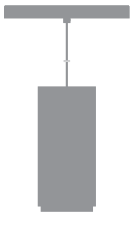
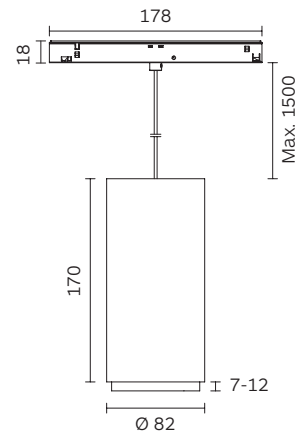

Zoom Spotlights

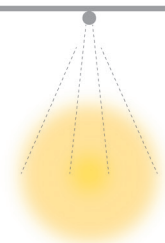

Zoom Spot 10° - 35°

Code ordering example: 9 7 1 1 B C 3 1 - 9 0 3 0 B S D 0 1 0

	Product Code	Product Length	Light Source Code*	>CRI	CCT**	LED Power	Nominal Lumen	Beam Angle (BA°)	Driver Options	Finish
Pixo Zoom 82 Low Voltage Pendant	9711	170	BC31 COB LED	90	30 3000K	11W	1160 lm	BS (10-35°)	D0 No Dim	10 ■ Black
					40 4000K	1260 lm	DA Dali Dim		11 □ White	
							DC CASAMBI			
							D1 0-10V Dim			

Notes:

* For complete code ordering information, please see page 51.

** For other CCT options, please contact us.

For the most updated product information, please go to our website.

BS: Beam shaping, Beam Angle: 10-35°, 35° field angle.

Palla Low Voltage

Low Voltage Track Pendant



Body

Pendant luminaire for 48V voltage track systems with light body in cast aluminium.

Supplied with integrated track adapter, compatible with different models of Stucchi low voltage track system, and 1.5m pendant wire.

Easy to insert and remove from the track.

Available in 2 different sizes.

Accessories

Honeycomb louvre.
For more information about low voltage track accessories see page 40-45.

Finish

Powder coat in black or white colour.

LED sources

COB LED.
CRI: 90 | CCT: 3000K, 4000K.
Other CRI and CCT versions available on request.

Optic

Lens.
Narrow, medium and wide beam angle available.

Driver

Supplied with no-dimable driver in the driver canopy.
Dimming Options: 0-10V, DALI, Phase, CASAMBI.
Power supply unit to be ordered separately, see page 46.

Applications

A crisp high tech designed ideal for both direct and indirect lighting applications and it integrates well with virtually any interior while offering excellent and different beam lighting distribution.
Application areas: retail, hotels, restaurants, offices, lobbies.

Compatible with Low Voltage Track Types

Please see P.40-41 for details

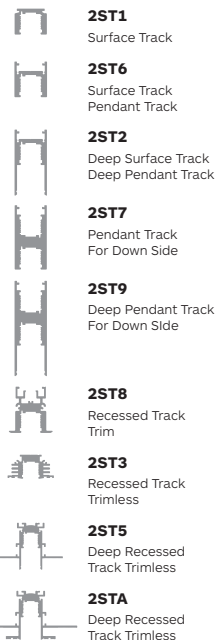

Palla Low Voltage Pendant



Palla 70 Low Voltage Pendant

Low Voltage Track

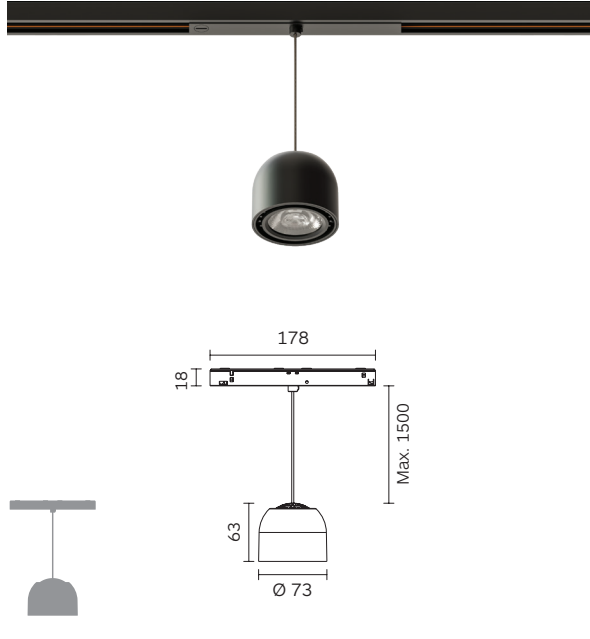

Palla 100 Low Voltage Pendant

Low Voltage Track

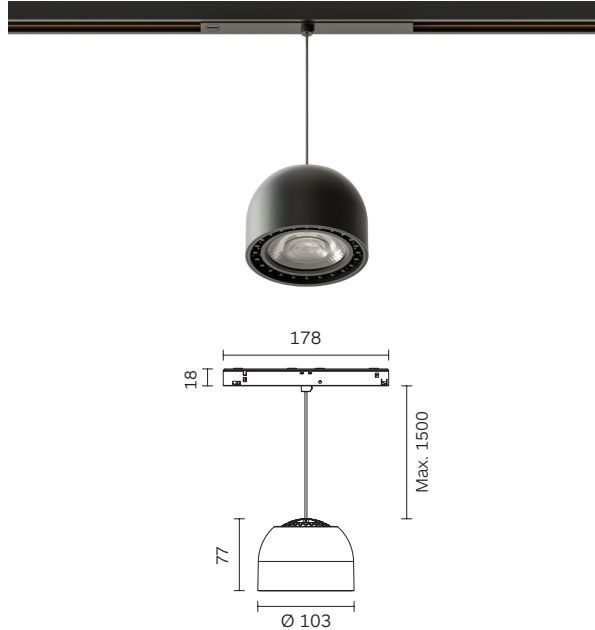

Code ordering example: 9 7 0 1 B C 2 2 - 9 0 3 0 1 6 D 0 1 0

	Product Code	Light Source Code*	>CRI	CCT**	LED Power	Nominal Lumen	Beam Angle (BA°)	Driver Options	Finish
Palla 70 Low Voltage Pendant	9701	BC22	90	30	12W	1500 lm	16 / 25 / 36	D0	10 ■ Black
				40		1550 lm			DA
Palla 100 Low Voltage Pendant	9702	BC33			21W	2200 lm	15 / 24 / 38	DC	CASAMBI
						2300 lm			D1

Optical Accessories

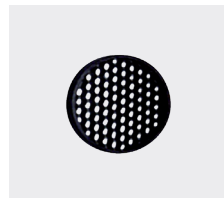

Product / Optical Accessories

Honeycomb Louvre
Colour 10

Palla 70 Low Voltage Pendant

2B95

Palla 100 Low Voltage Pendant

2B99

Notes:

* For complete code ordering information, please see page 51.

** For other CCT options, please contact us.

For the most updated product information, please go to our website.

Low Voltage Track Options

Recessed Trim Track

2ST8 + Art. 9202 Bracket with spring for 2ST8 included

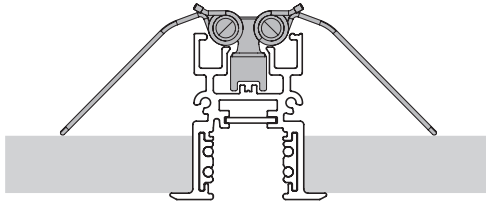

Recessed Trimless Track

2ST3 + Art. 9201 Bracket for 2ST3 trimless track included

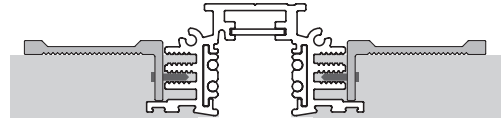

Deep Recessed Trimless Track

2STA

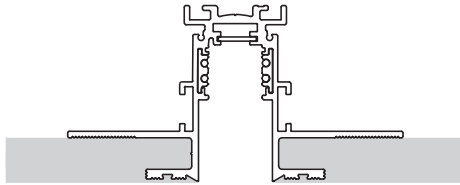

Deep Recessed Trimless Track

2ST5

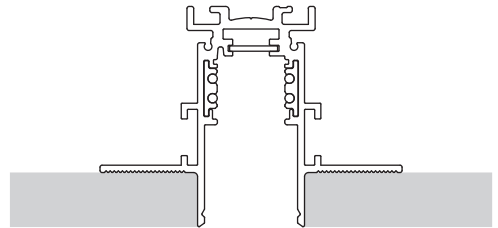

Pendant Track

2ST6 +
Pendant
Kits
Art.9226

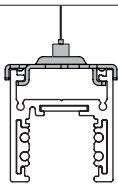

2ST2 +
Deep
Pendant
Kits
Art.9226

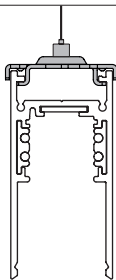

2ST7 +
Pendant
Kits
Art.9226

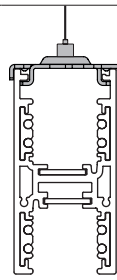

2ST9 +
Deep
Pendant
Kits
Art.9226

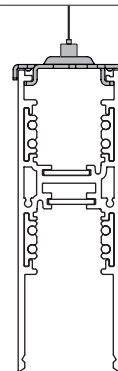

Pendant Kit

Pendant
Kit
Art. 9226

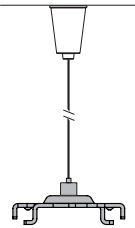

Surface Track

2ST6 +
Surface
Kits
Art.9225

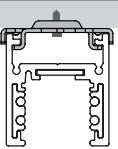

2ST2 +
Deep
Surface
Kits
Art.9225

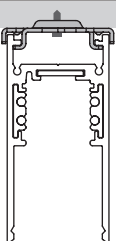

2ST1

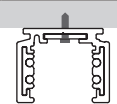

Surface Kit

Surface
Kit
Art. 9225



Compatibility

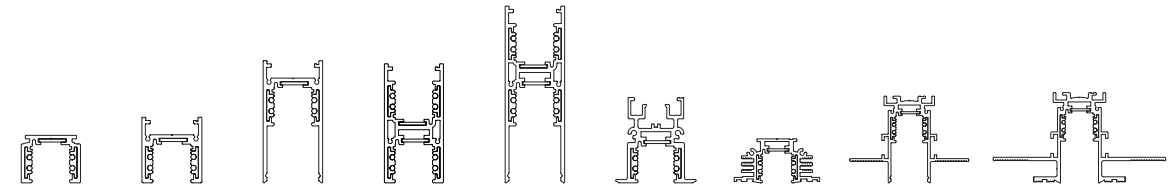

Track Options/ Product name	Surface Track 2ST1	Surface Track Pendant Track 2ST6	Deep Surface Deep Pendant Track 2ST2	Pendant Track 2ST7 Up & Down	Deep Pendant Track 2ST9 Up & Down	Recessed Track Trim 2ST8	Recessed Track Trimless 2ST3	Deep Recessed Track Trimless 2ST5	Deep Recessed Track Trimless 2STA
Polaris 20 & Polaris 20 Wallwasher Low Voltage	✓	✓	✓	✓	✓	✓	✓	✓	✓
Polaris 20 Opal Diffuser Low Voltage	✓	✓	✓	✓	✓	✓	✓	✓	✓
Polaris 20 Extended Arm Low Voltage	✓	✓	✓	✓	✓	✓	✓	✓	✓
Zero 40 / 66 / 100 Low Voltage	✓	✓		✓	✓	✓	✓		
Zero 40 / 66 / 100 Long Arm Low Voltage	✓	✓	✓	✓	✓	✓	✓	✓	✓
Zero Zoom 80 Low Voltage	✓	✓		✓	✓	✓	✓		
Zero Zoom 80 Long Arm Low Voltage	✓	✓	✓	✓	✓	✓	✓	✓	✓
Ola 55 / 100 / 130 Low Voltage	✓	✓		✓		✓	✓		
Ola Zoom 100 Low Voltage	✓	✓		✓		✓	✓		
Dado Low Voltage	✓	✓		✓		✓	✓		
Rolo Low Voltage	✓	✓		✓		✓	✓		
Conos 68 Low Voltage	✓	✓	✓	✓	✓	✓	✓	✓	✓
Polaris 20 & Polaris 20 Opal Diffuser Low Voltage Pendant	✓	✓	✓	✓	✓	✓	✓	✓	✓
Pixo 25 & 36 Low Voltage Pendant	✓	✓	✓	✓	✓	✓	✓	✓	✓
Pixo Zoom 82 Low Voltage Pendant	✓	✓	✓	✓	✓	✓	✓	✓	✓
Palla 70 & 100 Low Voltage Pendant	✓	✓	✓	✓	✓	✓	✓	✓	✓

Accessories

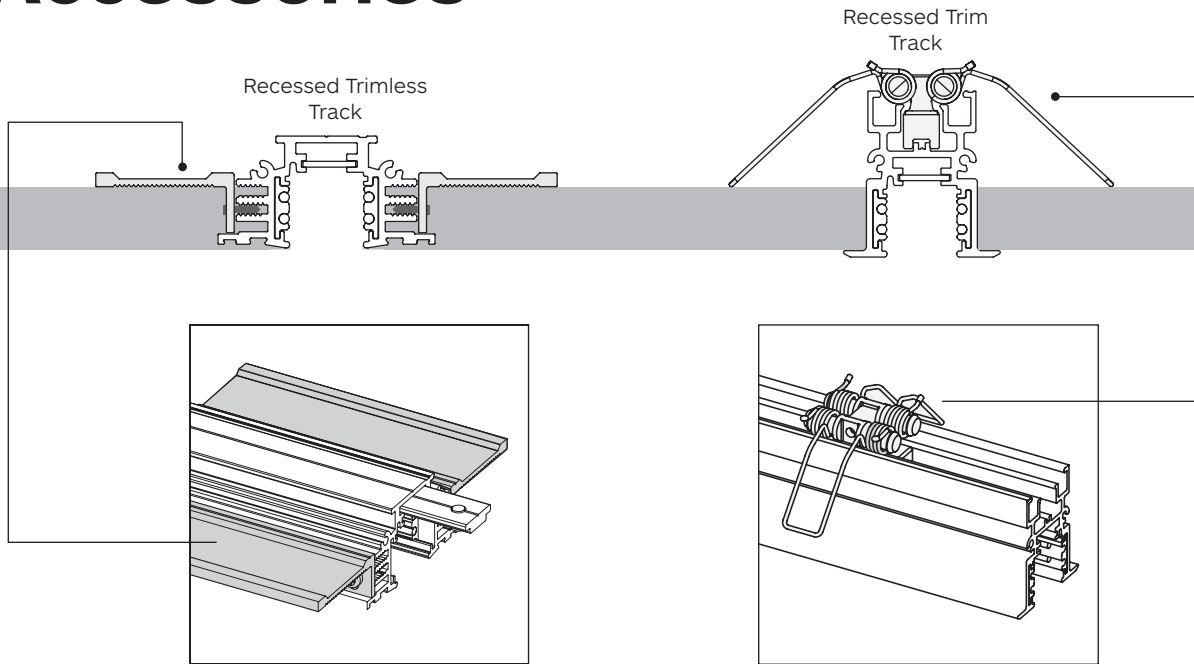

Bracket for 2ST3 Trimless Track
Art. 9201

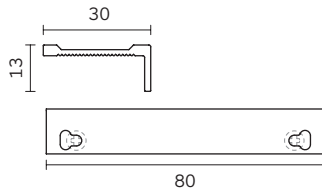

Bracket with Spring for 2ST8
Art. 9202

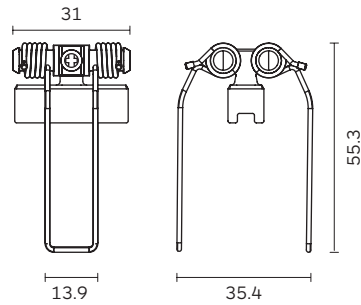

Low Voltage Track

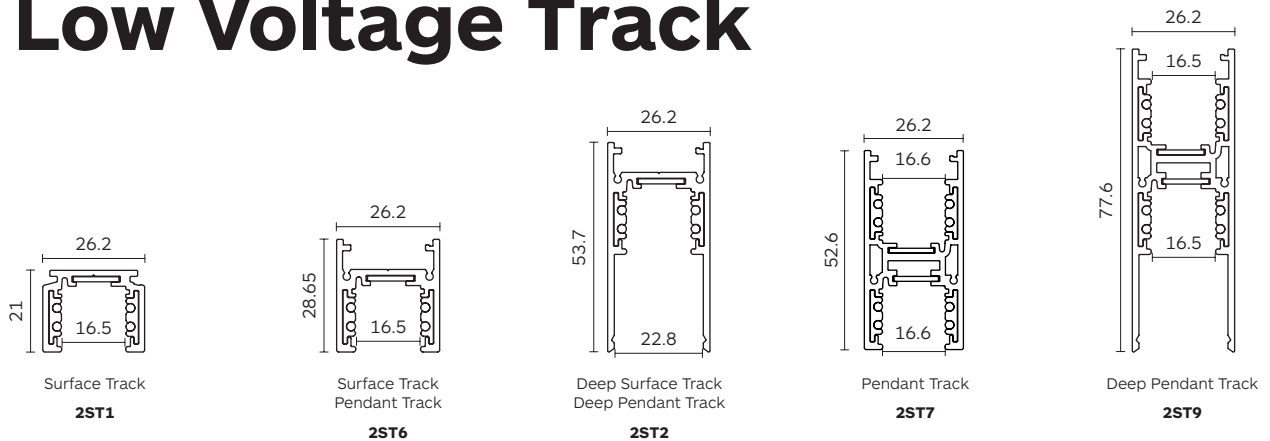

Surface Track

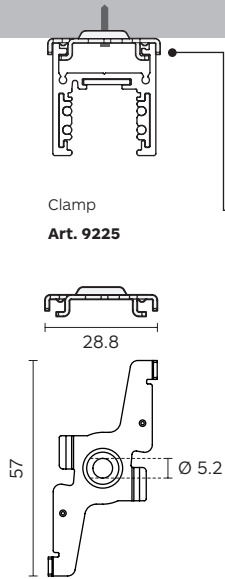

Clamp
Art. 9225

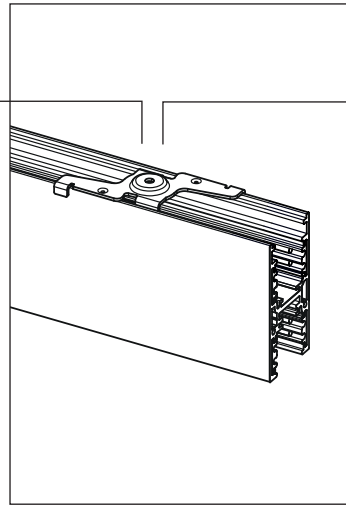

Pendant Track

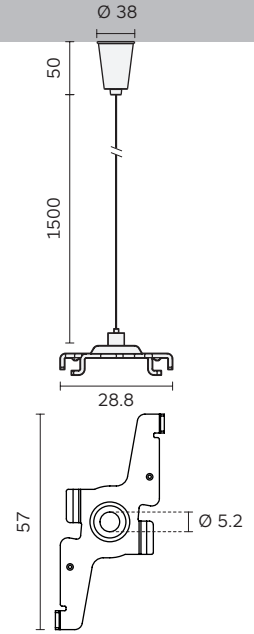

Clamp with wire Hanger
Art. 9226

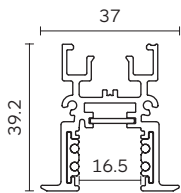

Recessed Track Trim
Art. 2ST8

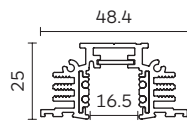

Recessed Track Trimless
Art. 2ST3

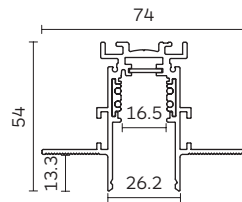

Deep Recessed Track Trimless
Art. 2ST5

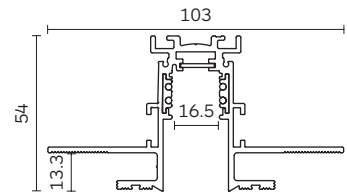

Deep Recessed Track Trimless
Art. 2STA

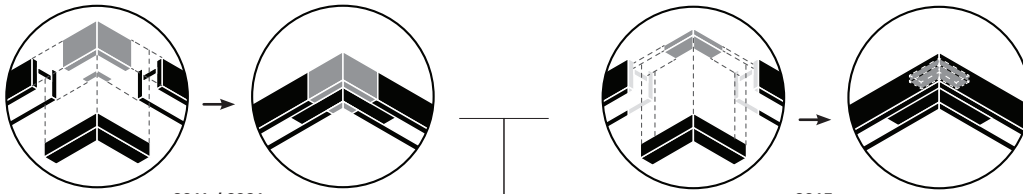

9214 / 9231
Cover for L Joint
(For 2ST2 / 2ST6)

9215
L Bracket for angles

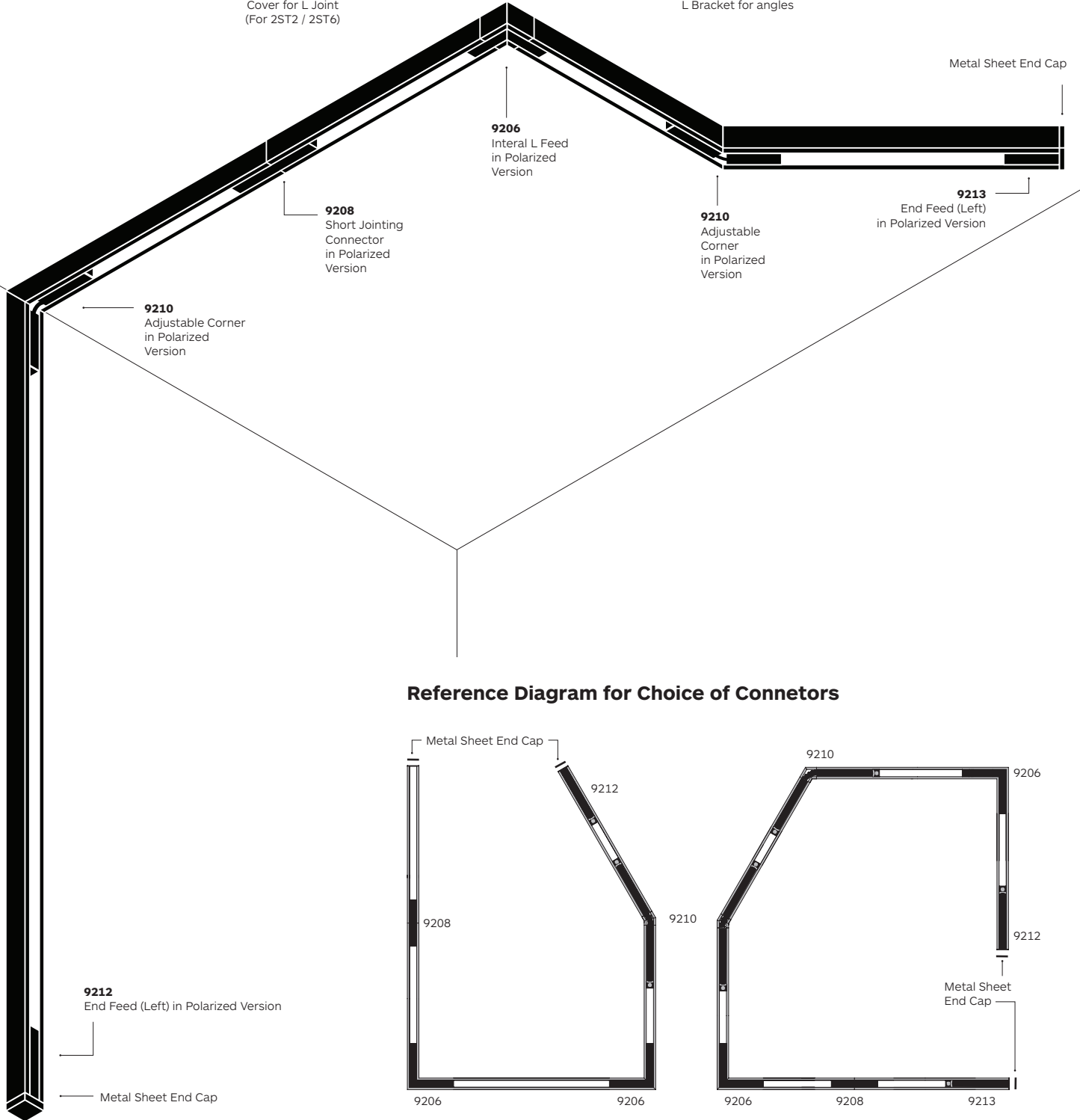

Reference Diagram for Choice of Connectors

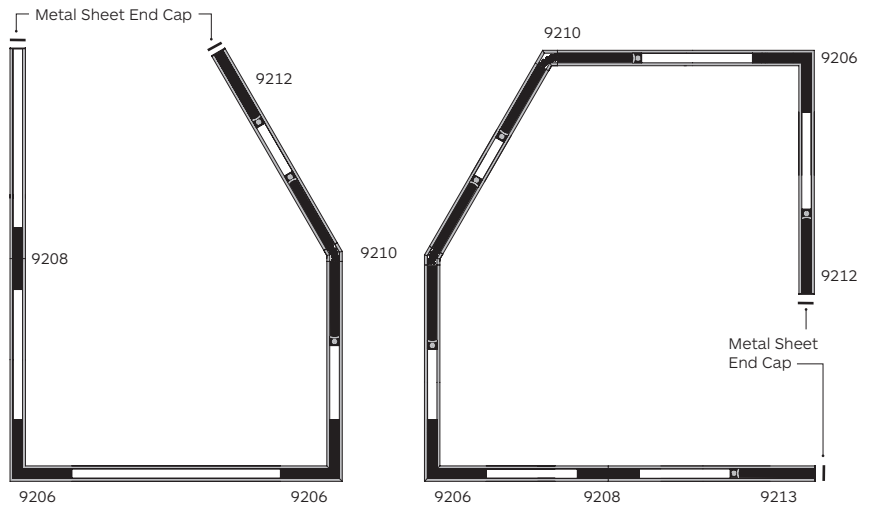

9212
End Feed (Left) in Polarized Version

Metal Sheet End Cap

Installation Components

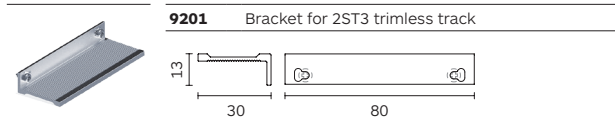

9201 Bracket for 2ST3 trimless track

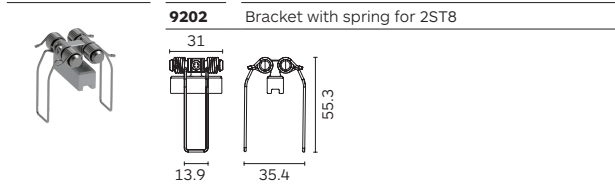

9202 Bracket with spring for 2ST8

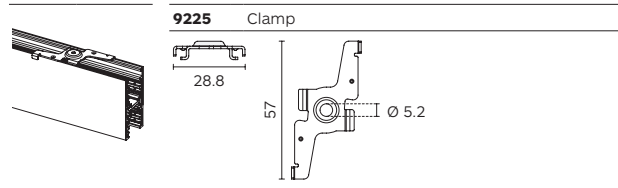

9225 Clamp

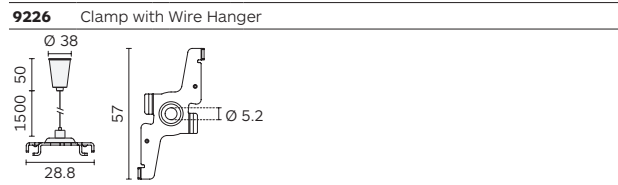

9226 Clamp with Wire Hanger

Accessories

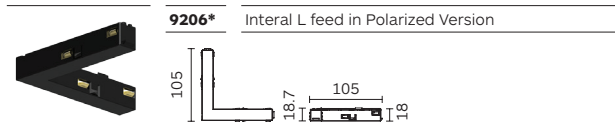

9206* Interl L feed in Polarized Version

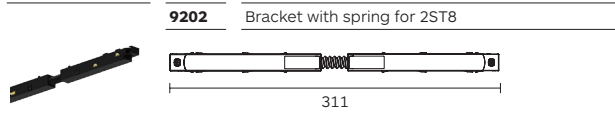

9202 Bracket with spring for 2ST8

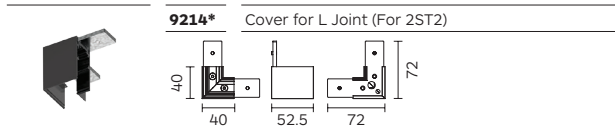

9214* Cover for L Joint (For 2ST2)

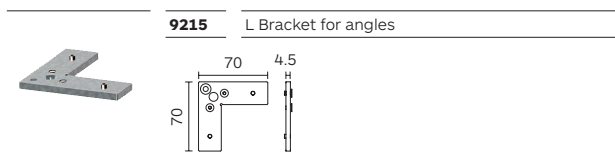

9215 L Bracket for angles

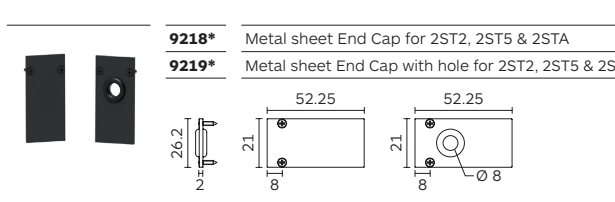

9218* Metal sheet End Cap for 2ST2, 2ST5 & 2STA

9219* Metal sheet End Cap with hole for 2ST2, 2ST5 & 2STA

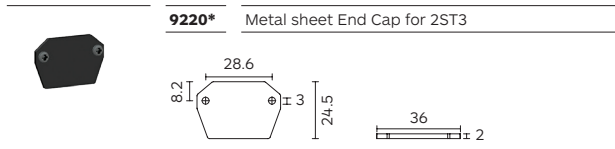

9220* Metal sheet End Cap for 2ST3

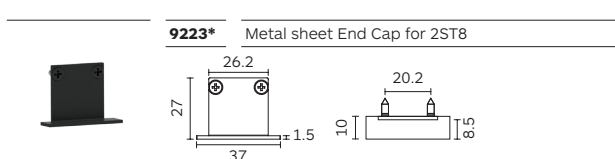

9223* Metal sheet End Cap for 2ST8

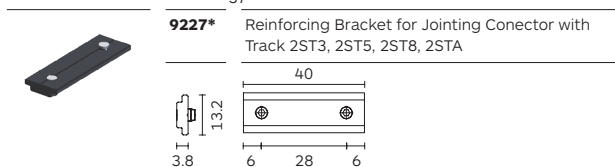

9227* Reinforcing Bracket for Jointing Connector with Track 2ST3, 2ST5, 2ST8, 2STA

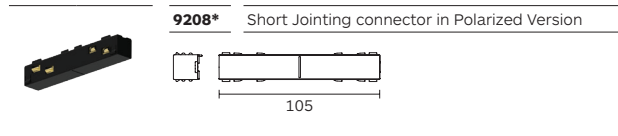

9208* Short Jointing connector in Polarized Version

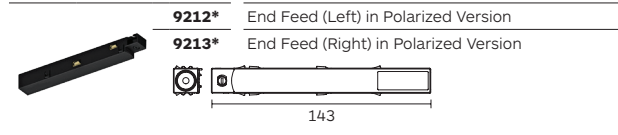

9212* End Feed (Left) in Polarized Version

9213* End Feed (Right) in Polarized Version

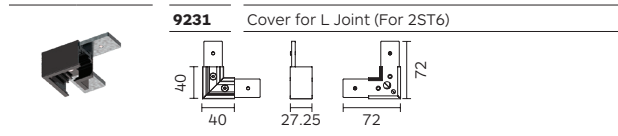

9231 Cover for L Joint (For 2ST6)

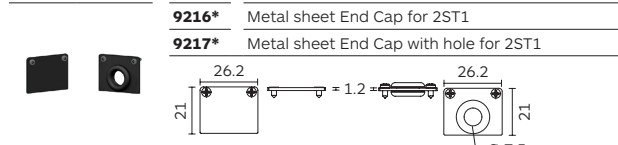

9216* Metal sheet End Cap for 2ST1

9217* Metal sheet End Cap with hole for 2ST1

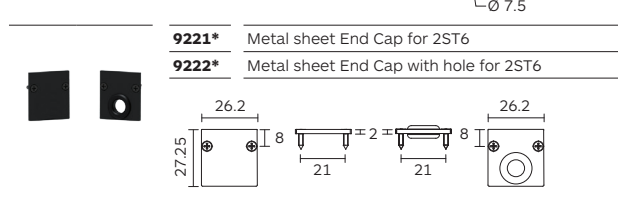

9221* Metal sheet End Cap for 2ST6

9222* Metal sheet End Cap with hole for 2ST6

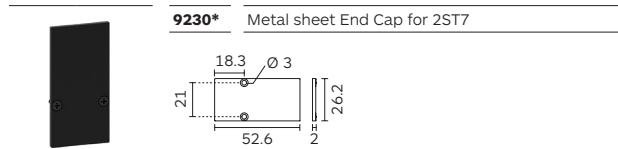

9230* Metal sheet End Cap for 2ST7

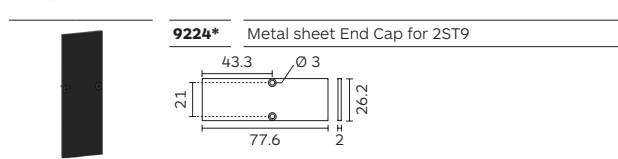

9224* Metal sheet End Cap for 2ST9

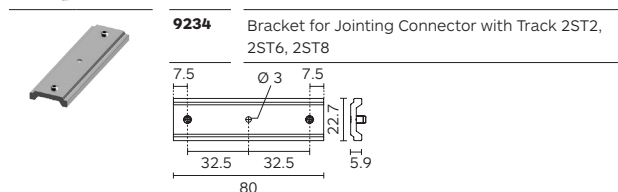

9234 Bracket for Jointing Connector with Track 2ST2, 2ST6, 2ST8

Notes:

* Available in colours 10, 11

Power Supply & Control Options

Power Supply

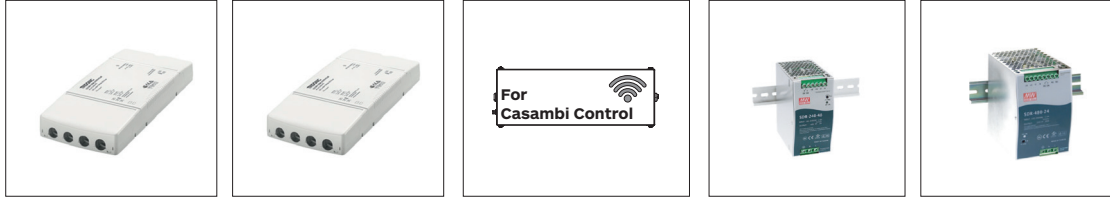

220-240VAC input, 48VDC output 75w power supply for low voltage track

220-240VAC input, 48VDC output 150w power supply for low voltage track

220-240VAC input, 48VDC output 150w power supply for low voltage track with Casambi wireless 0-10V dimmer

220-240VAC input, 48VDC output 240W, DIN rail power supply unit for low voltage track

220-240VAC input, 48VDC output 480w, DIN rail power supply unit for low voltage track

Code	2E28	2E29	9229	2E30	2E31
Size	100 x 235 x 31	100 x 235 x 31	98 x 255	Max. 63 x 125.2 x 113.5	Max. 85.5 x 125.2 x 128.5

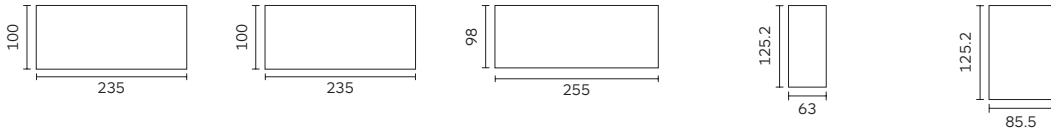

150W Power supply with integrated wireless CASAMBI Control to 0-10V interface

9229



150W Power supply with integrated DALI interface

9232



150W Power supply with integrated 0-10V (isolated) interface

9233

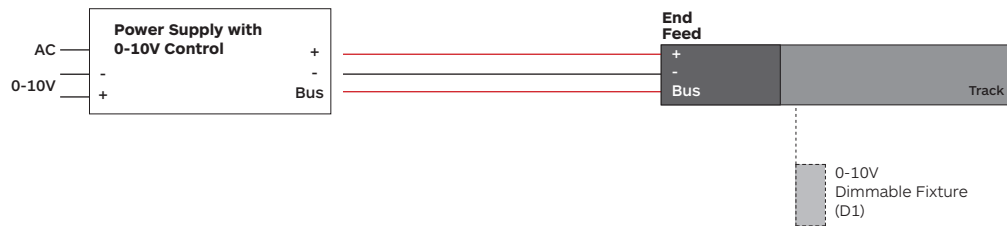

Dimming Interface

ITALED DALI Interface for Low Voltage Track 48V

2101

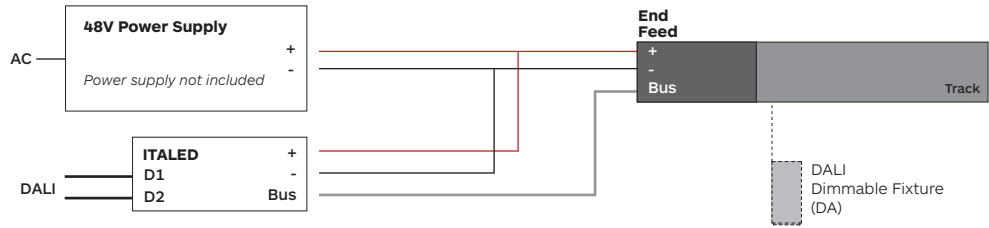

ITALED 0-10V (Isolated) Interface for Low Voltage Track 48V

2102

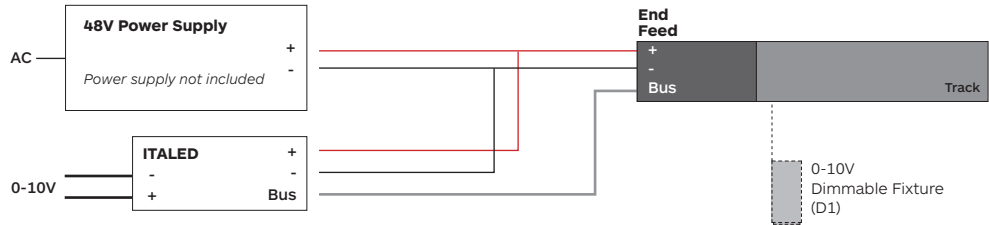

Drop Voltage Table

Power Supply (W)	A Distance power supply/feed unit (2x1.5mm ²)			
	5m	10m	20m	30m
	B Track Length with $\Delta v \leq 5.5\%$ (m)			
	(m)	(m)	(m)	(m)
60	50	50	50	50
100	50	50	40	25
150	50	40	20	Not admitted
200	40	30	Not admitted	Not admitted
250	35	20	Not admitted	Not admitted

Information refers to a load equivalent to the power supplied and equally distributed on the relevant length in the table.

Remote Power Supply

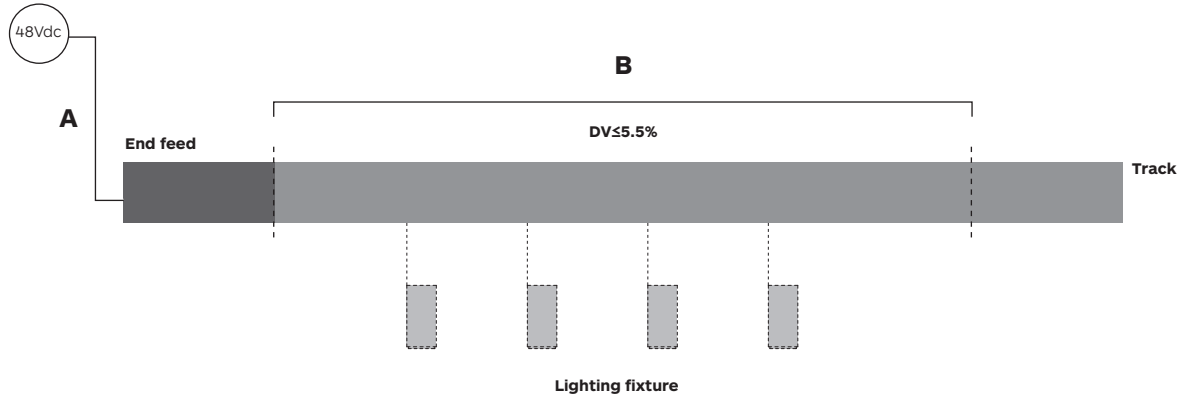

Symbols & Icons

Code system

Global presence

Symbols & Icons

The CE mark signifies that a product conforms with the relevant ECC directives requirements. The CE marking is compulsory to indicate LVD and EMC conformity.

The CE mark is also a self certification that the manufacturer claims that the product is safe. The value of such claim is directly related to the case of FormaLighting: All products are designed, developed, manufactured under the scope of ISO 9001 quality systems.



All formaLighting products are tested in Europe and certified by an independent laboratory that is registered and audited by an approved European testing authority.

Others third party product approvals

Our products include electrical and electronic components that carry other world wide Test House approvals such as those shown:



CLASS I

Luminaires of insulation Class I - with earth connector.



CLASS II

Luminaires of insulation Class II - With safety isolation, this means the tension conduction element are protected by additional isolation.



The isolation of an earth wire it is not necessary and the connection to it is not allowed.

CLASS III

Luminaires of insulation Class III - designed for operation of protected low voltage supply (>42V).



Zoom



Passes the 850C glow wire test in accordance with ICE 695-2-1.



Passes the 960C glow wire test in accordance with ICE 695-2-1.



Degree of Ingress Protection*



Dim2Warm



Tuneable White



Recyclable



IP__ Degree of Ingress Protection

1st Number	Protection Against Dust and Solid Objects	2nd Number	Protection Against Moisture and Liquids
0	No-Protection	0	No-Protection
1	Protection against solid objects >50 mm	1	Protection against dripping water
2	Protection against solid objects >12 mm	2	Protection against dripping water tilted > 15 deg
3	Protection against solid objects >2.5 mm	3	Protection against spraying water > 30 deg
4	Protection against solid objects >1 mm	4	Protection against spraying water
5	Dust - protected	5	Protection against water jet
6	Dust - tight	6	Protection against waves
		7	Protection against the effects of immersion
		8	Protection against submersion

LEDs in formalighting Luminaires

Lumenetix

Citizen

Cree

Luminus

Osram

Nichia

Code system

Code ordering examples:

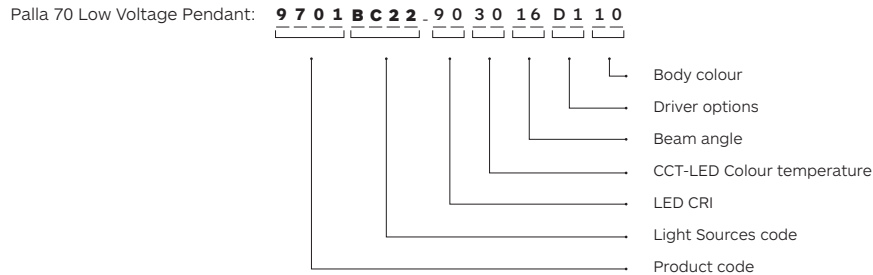

LED CRI

90	CRI > 90
97	CRI > 97

Driver Options

D0	No dimming
DA	Dali Dim
DC	CASAMBI
D1	0-10V Dim

Body Colour

10	Black (RAL 9004)
11	White (RAL 9003)
*17	Black (RAL 9004) / White (RAL 9003) (B&W)
75	Grey (RAL 9006)

CCT-LED Colour temperature

27	Warm White 2700K
30	Warm White 3000K
35	Warm White 3500K
40	Neutral White 4000K
TW	Tuneable White 2700K - 6500K

Notes:

***17:** white light body with black integrated louvre. For black body with white integrated louvre consult us.

How to order

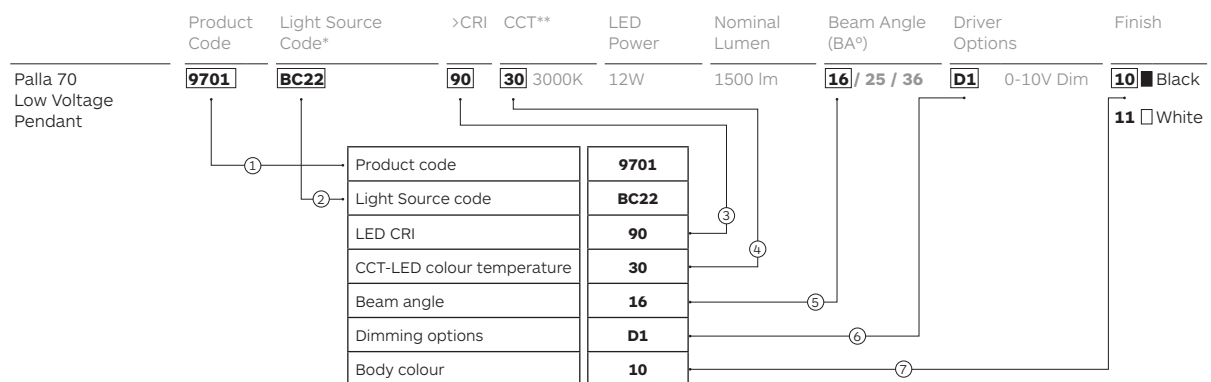

All dimensions in the catalogue in mm

Global presence

Celebrating 50 years of vision, dedication and innovation, Formalighting's versatile and high-quality product offerings extends internationally via our headquarters in Hong Kong, London, Milan, Shanghai and the USA.

Our well chosen and selected partners as well as our affiliated international offices broaden our global presence further in markets such as Australia, Japan, South East Asia, India and the Middle East.

Through our commitment to growth and investment within formalighting's professional team, infrastructure and product ranges, we are able to provide increasing service to our global retail and hospitality clients as well as lighting designers and specifiers strengthening our position as a leading international supplier of innovative architectural lighting solutions and systems.

With 50 years' experience in designing and manufacturing architectural lighting, formalighting's comprehensive portfolio offers a competitive range of European designed and expertly engineered products that carry CB, CE, CCC and UL certifications.

Furthermore formalighting's latest award-winning motorized range of track, pendant, and recessed fixtures, featuring remote-controlled adjustable pan and tilt, dim, dim to warm, tuneable white and beam shaping lens, are available worldwide incorporating the latest, most advanced lighting technologies.

Headquarters

Europe / Milan

Tel (+39) 02 9354 0300

Fax (+39) 02 9343 5117

E-mail formaitalia@formalighting.it

Asia / Hong Kong

Tel (+852) 2516 6500

Fax (+852) 2516 6525

E-mail forma@forma.com.hk

USA / New York

Tel (+1) 470 419 4003

E-mail info.us@formalighting.com

Formalighting is constantly developing and improving its products therefore all information, drawings illustrations, specifications, photometric values in this catalogue are indicative and shall not form part of any commitment to our company that reserve the right to change specifications without prior notification or public announcement. Technical information on the installation-instruction has precedence over the information in the catalogue. Our general terms and conditions shall apply notwithstanding any stipulation on the contrary to all the orders and agreement with formalighting. You can obtain a copy of these conditions on demand.

Publication date: May 2020
©Copyright formalighting

With thank to all contributors for the realization of this catalogue

Designed by formalighting Graphic Design Department

No part of this catalogue may be copied without written authorization of formalighting

formalighting

HONG KONG

-

LONDON

-

MILAN

-

SHANGHAI

-

NEW YORK

Light Your Brain Desires

SunLike
Powered by 

<http://www.seoulsemicon.com/en/technology/Sunlike/>



<https://www.toshiba-tmat.co.jp/en/tri-r.htm>

Powered by
Toshiba Materials Co.,Ltd

<https://www.toshiba-tmat.co.jp/en/>

SunLike
Powered by 

<http://www.seoulsemicon.com/en/technology/Sunlike/>



<https://www.toshiba-tmat.co.jp/en/tri-r.htm>

A spectrum leading us to the future



The brain has immense capabilities, and runs every part of you.
It perceives color, and controls the biological clock that maintains your bodily functions.
The development of SunLike began by focusing on the spectrum of light,
which fulfills an important role for these mechanisms.

Your eyes are sensors. Three types of photoreceptor cells on the retina detect the intensity of light on different wavelengths, and transmit this information as signals to the brain.
The brain then perceives this color and, at the same time, issues various instructions.
From this perspective, the idea of what it means
for humanity to have light is now attracting attention all around the world.
SunLike is a human-centric, LED spectrum technology that will open the way to humanity's future.



Light, the brain, the body.

Light and the biological clock

From the time we are born, a biological clock is running not only in our brains, but in each of the countless cells throughout our bodies. This clock naturally operates on a cycle of about 25 hours, but synchronizes with our 24-hour day as the morning light causes a daily correction. This is one way that light is used not only to view objects, but also to maintain our biological functions, and is an important component to sensitivity.

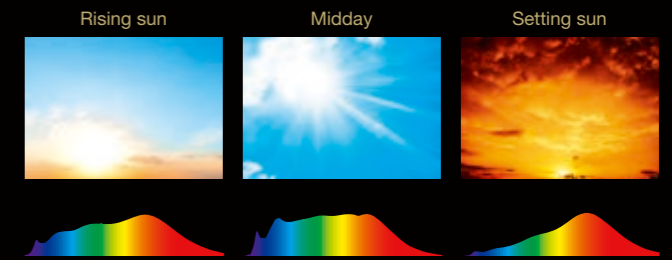

Same perceived color does not mean same spectra

When a spectrum enters the eye, our photoreceptor cells measure the respective intensity of blue, green, and red light. The retina converts and transmits this data to the brain, where it is perceived as colors and luminosity. In other words, the brain interprets the results of calculations, and is not capable of recognizing spectra directly. This allows the brain to recognize the same colors in different spectra, such as natural light, artificial light, or images on a display.

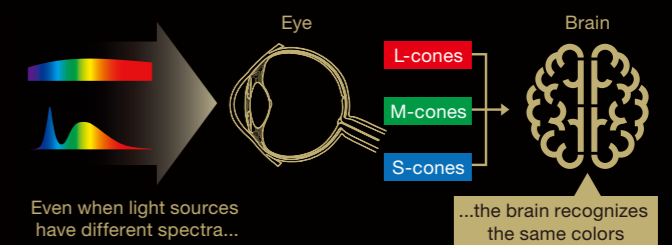

Photoreceptor cells transmit light changes throughout the day to the brain

In 2002, scientists discovered the existence of ipRGCs (intrinsically photosensitive retinal ganglion cells), which transmit the intensity of blue light, a major part of morning light. We now know that these photoreceptor cells control the biological clock. This in turn suggests that spectra might affect the biological clock through ipRGCs. Research is showing us the effects on organisms of intensities in the blue portion of the spectrum that differ from those in natural light, even with light that we perceive as being the same color. This research focuses on disruptions to the biological clock and the resulting degradations in sleep quality, as well as risks involving other illnesses.

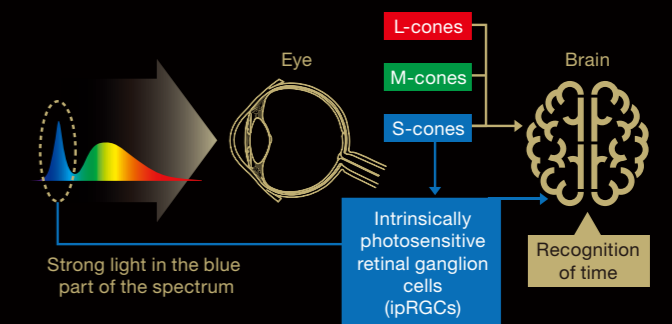



Light closest to that of the sun

SunLike
Powered by

Combination of Seoul Semiconductor's compound semiconductor technology and Toshiba Material's TRI-R technology

TRI-R, a next-generation LED spectrum technology

TRI-R light-emission principles

The light from an ordinary white LED is created from the combination of light emitted from a blue LED and light emitted by exciting fluorescent materials. But with TRI-R, virtually all of the excitation light from a violet LED is converted into light emitted from fluorescent materials, which results in a natural and continuous spectrum that is very close to that of sunlight, one that does not have excessive peaks or deficiencies at specific wavelengths.



Spectral comparison of 5000 K color temperature

Sunlight

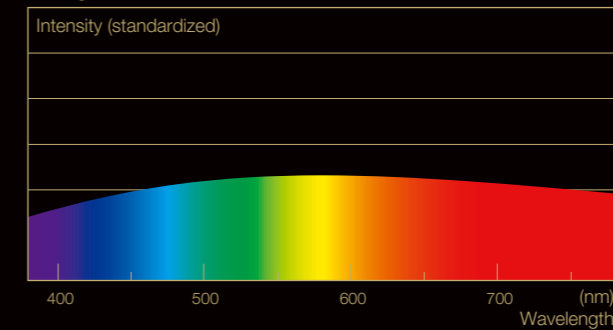

SunLike

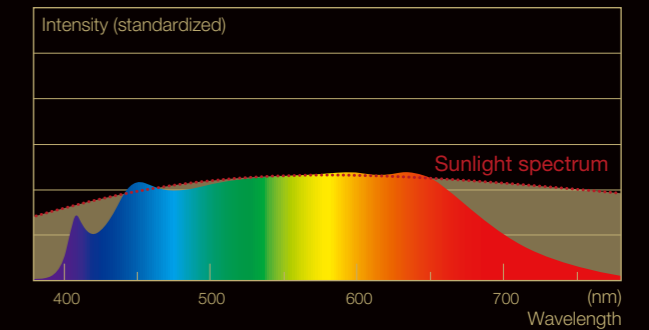

Ordinary LED (B+YR)

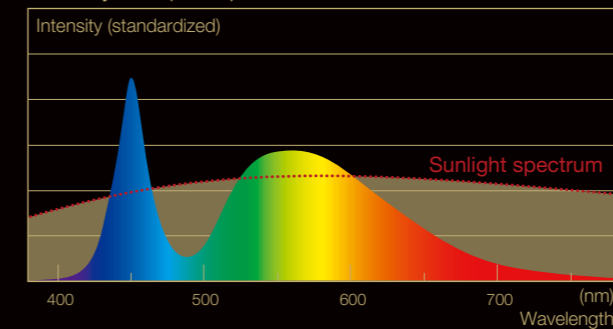

Fluorescent light

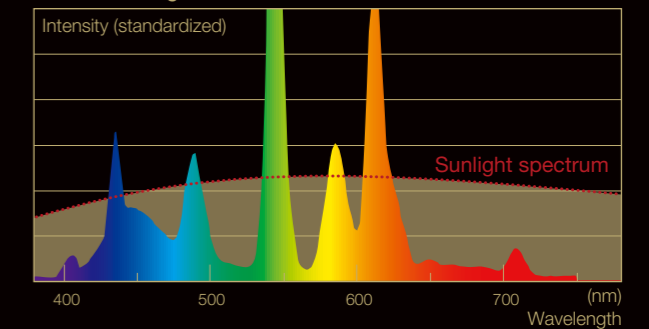

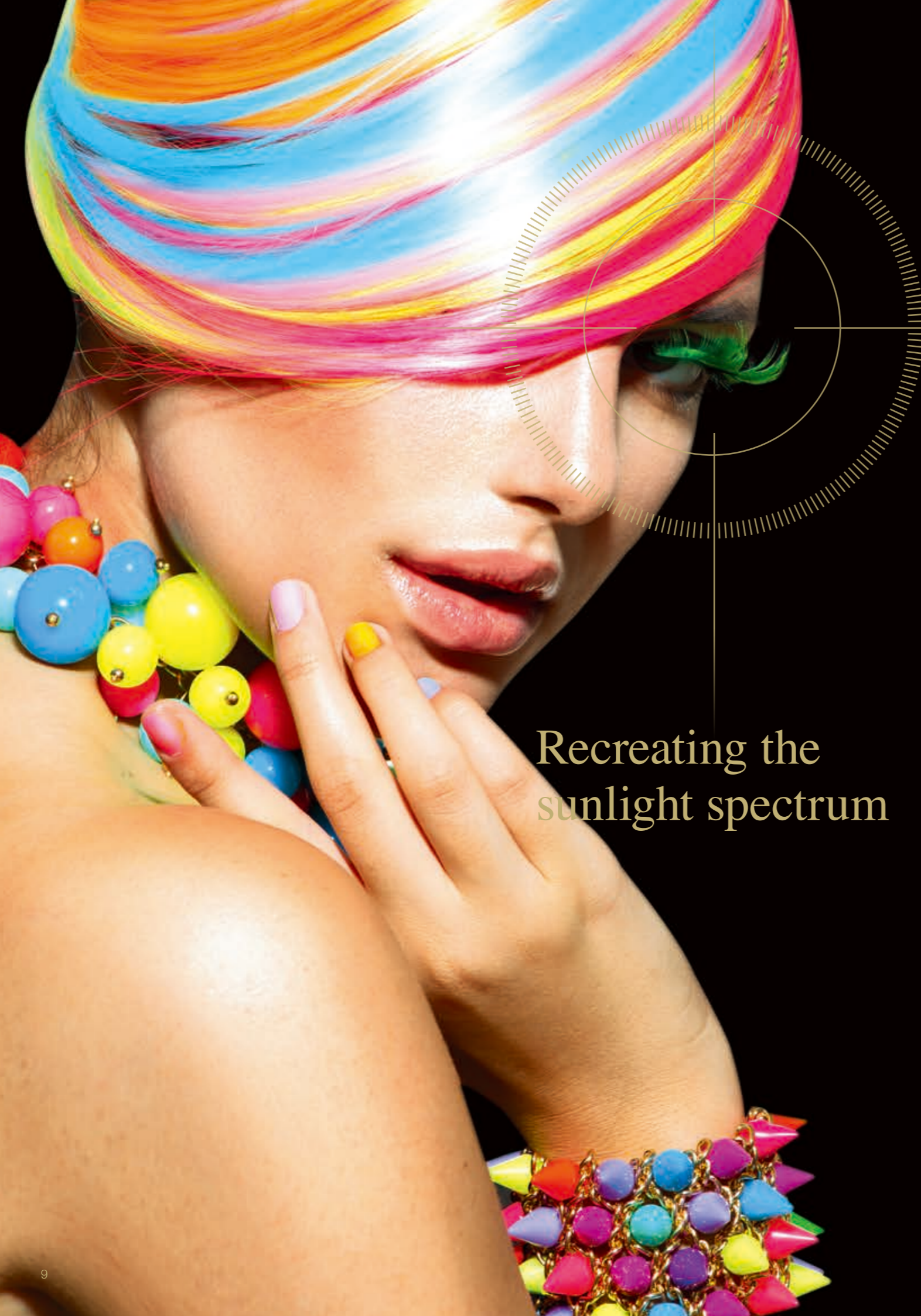

Recreating the sunlight spectrum

Faithful reproduction of natural colors, contrasts, and three-dimensionality

Artists select colors and brush strokes to create depth and perspective when viewed under natural light, and viewing paintings under the same lighting with which the artist created them is one way to properly appreciate them. SunLike faithfully illuminates paintings as they would appear under sunlight in terms of color and contrast. We must also not forget texture, or three-dimensionality, when illuminating works of art, fashion, or interior design. SunLike delivers a natural spectrum without excessive blue light, which is easily scattered, and therefore produces specular reflection from the surface of objects, imparting a greater sense of three-dimensionality and texture.

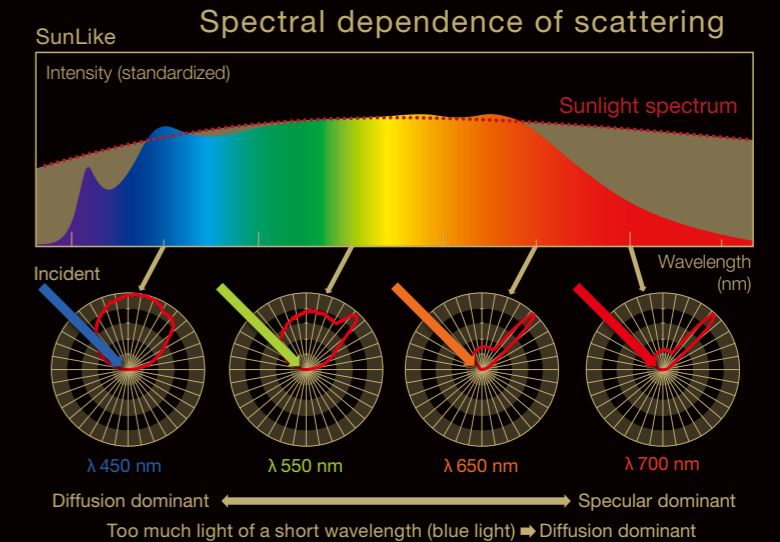

Superb color rendering and expression of texture

Sometimes the color of clothing looks different outside than it did in the store. This happens because the spectrum of light in the store differs from that of natural light. Color rendering indicates the effect that a light source has on how the colors of objects are perceived, with 100 representing colors under natural light. SunLike exhibits superior color rendering properties, with a value close to 100 when using not only the traditional CRI (Color Rendering Index) standard, but also the new TM-30-15 standard (the IES Method for Evaluating Light Source Color Rendition). The technology expresses natural colors at events such as exhibitions of European art and fashion shows.

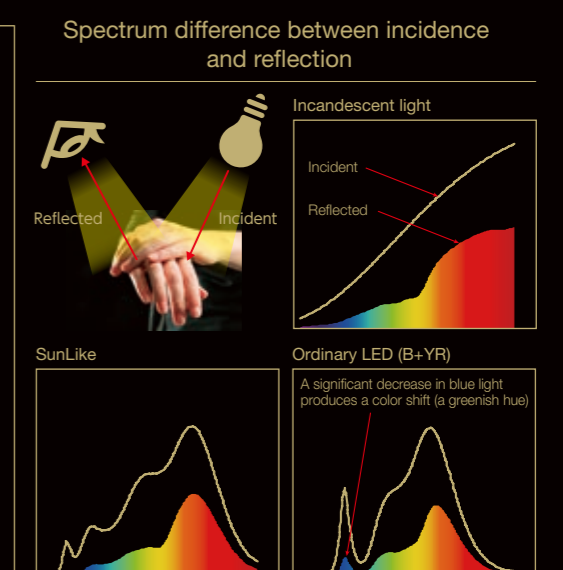
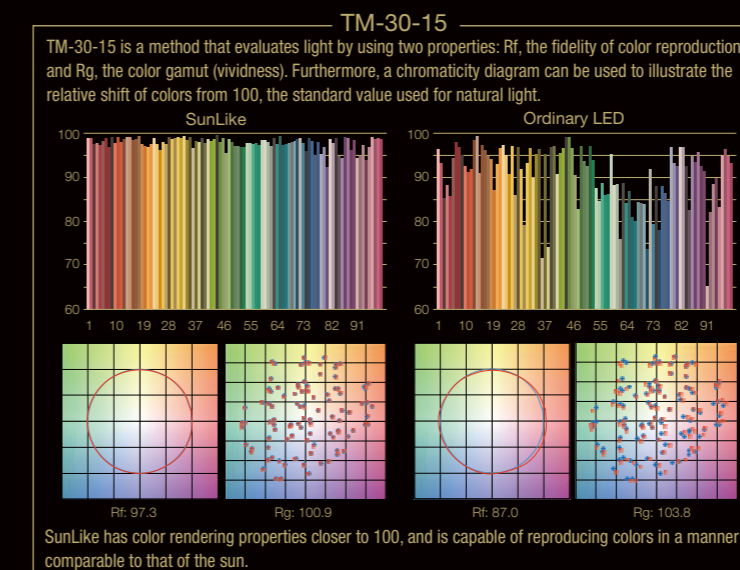



True-to-life expression

Rendering high-quality scenes with depth

SunLike allows for superb color rendering and expression of texture. Art galleries, showrooms, shops, hotels, and restaurants are just some examples of places that are capable of maximizing this potential. The light from SunLike produces natural scenes with depth in various spaces.



Skin
With light that is exceedingly close to that of the sun, SunLike can illuminate human vitality. The technology allows for the accurate expression of the natural colors and textures inherent to the skin.



Japanese clothing
SunLike lighting clearly brings out colors ranging from faint to vivid. The beauty of the meticulous weaving of clothing items is depicted in every detail.



Leather
SunLike faithfully reproduces the appearance of even monotone leather products and other items that do not have an easily perceived texture. Viewers are able to recognize the craftsmanship that has gone into such items.



Gold
Because of SunLike's natural and smooth, continuous spectrum, the technology is capable of accurately revealing the deep luster of objects made of gold, and the accompanying feeling of luxury.

Excellent visibility, with little glare

An ordinary LED light source transmits a strong beam of light from a blue LED, which scatters greatly due to its short wavelength and high energy. This scattering occurs not only on an illuminated object but within the eye itself, where it is easier to perceive shimmering and glare. Because SunLike does not contain a high-intensity blue light component, the technology provides light that offers excellent visibility with little glare.

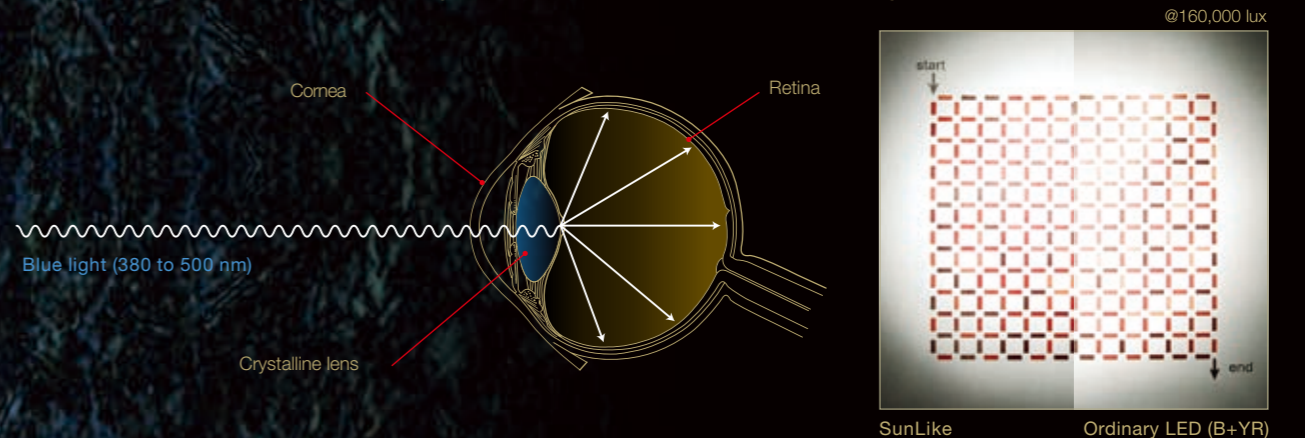

Awards winner in 2018



Elektronik Award
(Mar 2018)

1st innovative Product of the
Year Award



15 great Tech. of the year
(Sep 2018)

15 great technologies of
the year awarded by the
Korean Engineering Academy



EDISON AWARDS
(May 2018)

Edison Awards Top 10
Must See Product



OFweek China LED
Lighting Awards 2018
(Oct 2018)

Most Creative LED Technology



IES Progress Report
(Aug 2018)

Innovative SunLike LEDs Earn
Industry Recognition in 2018
IES Progress Report



IBuilding Green Top 10
Product for 2019
(Nov 2018)



Best application Awards
(Sep 2018)

LED Professional
Symposium In Bregenz



2018 Lux Awards
(Nov 2018)

Enabling Technology
of the Year

araya⁵[®]

TUNABLE COLOR



araya⁵ Color Tuning LED Modules (CTM1C)
24V DC Input (Constant Voltage)
2000 Maximum Peak Lumens

Data Sheet

TABLE OF CONTENTS

- 1 Description and Ordering Information

- 2 Electrical and Mechanical Specifications

- 3 Heat Sinking Recommendations

- 4 Power Supply Requirements

- 5 Case Temperature Measurement Points

- 6 Secondary Optics

- 7 Power / Control Cable Assemblies

- 8 Wiring Diagrams

- 9 Operation Guide

1 DESCRIPTION AND ORDERING INFORMATION



CTM 109



CTM 112



CTM 119
(1250 / 1000 / 750 LM)



CTM 119NR

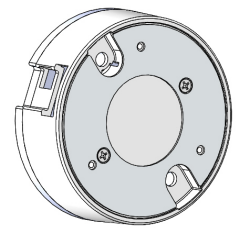

CTM 119
(2000 / 1500 LM)

Description

araya⁵ Color Tuning Modules mix five colors of LEDs to deliver tunable and dimmable white light at 90+ CRI* and color consistency of <2 MacAdam ellipse across a tuning range of 1650 - 8000K. Light can be dimmed from 100 - 1% while maintaining constant CCT. Gradients of saturated colors from 1 - 100% can be added to color points within the tuning range. araya⁵ modules integrate the driver electronics for precise control of current and PWM inputs and LED light output. On board closed loop thermal feedback compensates each color channel for thermally induced variations in optical output due to tuning, dimming or ambient temperatures. On board closed loop optical feedback measures the lumen depreciation of each channel and re-balances the color model to ensure color consistency over the 50,000 hour life of the module. An in-line manufacturing process captures the spectral characteristics of each LED under multiple conditions, generating a unique color model for each color tuning module. The modules are compatible with traditional 0 - 10V wired controls, feature on-board DMX512-A-RDM, and also Bluetooth Low Energy (BLE) for commissioning. Lutron[®] EcoSystem compatibility is achieved by using the optional Lumenetix Digital Control Adapter. Modules can be paired with Legrand's Wattstopper[®] Digital Light Management (DLM) interface via an external adapter, to allow automatic fixture commissioning. For simple deployment, scene set allows up to five scenes to be pre-programmed into the module during production and recalled at the venue using a 0 - 10V recommended dimmer. Commissioning of the module, re-programming of scenes, and configuration of DMX channels is done via RDM or the wireless araya⁵ Tunable Color 2.0 iOS app that connects to the embedded radio. The CTM1 series features nominal light emitting surfaces (LES) of 9 mm, 12 mm and 19 mm.

Key Features

- Tunable range: 1650 - 8000K
- 90+ CRI*
- Dimmable from 100% - 1% at constant CCT
- Color gamut control: gradients of saturated colors from 1 - 100% can be added to color points
- Integrated driver electronics
- On board thermal and optical feedback for color consistency of <2 MacAdam ellipse over 50,000 hour life
- In-line spectral capture creates unique color model for each module, resulting in consistent CRI and CCT across all modules
- On board thermal turndown
- Compatible with 0 - 10V wired controls
- On-board Bluetooth Low Energy (BLE) for commissioning
- On-board DMX512-A-RDM, with DMX slots set by RDM or via wireless araya⁵ Tunable Color 2.0 iOS app
- Lutron EcoSystem compatibility via optional Digital Control Adapter
- Wattstopper DLM compatibility via an optional adapter
- Scene set enables up to five scenes to be preprogrammed and recalled using a 0 - 10V recommended dimmer
- Light emitting surface (LES): 9 mm, 12 mm and 19 mm (nominal)
- Zhaga compliant footprint and front heat sink mounting
- Provisions for reflector mounting



araya⁵ Tunable Color 2.0 iOS App

Photometrics and Ordering Codes

Tunable Range: 1650 - 8000K	Nominal Wattage	CTM 109		CTM 112		CTM 119 / 119NR		
		Typical Peak Lumens	Ordering Code	Typical Peak Lumens	Ordering Code	Typical Peak Lumens	Ordering Code (CTM 119)	Ordering Code (CTM 119NR)
Specifications**	35W	N/A	N/A	N/A	N/A	2000	80.002.082.01	N/A
	25W	N/A	N/A	N/A	N/A	1500	80.002.083.01	N/A
	25W	950	80.002.045.01	1000	80.002.048.01	1250	80.002.051.01	80.002.054.01
	18W	750	80.002.046.01	900	80.002.049.01	1000	80.002.052.01	80.002.055.01
	12W	550	80.002.047.01	650	80.002.050.01	750	80.002.053.01	80.002.056.01
CRI (Ra) Across Tuning Range	>90*							
Dimming	100% to 1% in increments of 1% at constant CCT							
Nominal Color Consistency	<2 MacAdam ellipse (±0.002 Duv from ANSI C78.377-2008 curve)*							
Color Consistency Over Life	Calibration maintains original color points over life*							
Lumen Maintenance	L70 (70% of initial lumens) at 50,000 hours							

*From 2000 - 6000K, down to 5% dim level. **Lumen and wattage range is within +/- 10% of the nominal value. Peak efficacy is not necessarily at typical peak lumens.

2 ELECTRICAL & MECHANICAL SPECIFICATIONS

2.1 Electrical Specifications

Input Voltage	24V DC
Nominal Power Input	35, 25, 18 and 12 Watts
Nominal Current Input	35W: 1.46A; 25W: 1.04A; 18W: 0.75A; 12.5W: 0.5A
Power Supply Classification	Class 2
Power Connector	Molex 874380243 (requires Molex 874390200)
Control Connector	Molex 874370543 (requires Molex 874390700)
Control Options ¹	0 - 10V, DMX512-A-RDM ² , Lutron [®] EcoSystem, Wattstopper [®] DLM
CCT and Dimming Control Connections	Connector harness, 24 gauge leads

- DMX channel configuration is done via RDM or wireless Tunable Color iOS app. Lutron EcoSystem requires optional Digital Control Adapter. Wattstopper DLM compatibility requires optional external adapter from Wattstopper.
- Remote Device Management or RDM is a protocol enhancement to DMX512-A that allows bi-directional communication between a lighting or system controller and attached RDM compliant devices over a standard DMX line.

2.1a Control Specifications

PROTOCOL	1 DIMMING	2 CCT	3 SAT	4 HUE	NOTES
DMX512-A-RDM	1%	1650 - 8000K	1 - 100%	1 - 60°	
0 - 10V	~1% ¹	1650 - 8000K	*	*	1. 1 - 10V signal dims module to approximately 1%. In-line power relay required to achieve 0% output.
LUTRON ECOSYSTEM ²	1%	1650 - 8000K			2. Requires external Digital Control Adapter.
WATTSTOPPER DLM ³	1%	1650 - 8000K			3. Requires external LMFC-LXI adapter by Wattstopper.

*Two 0-10V lines can be used to control DIM and CCT independently, or program Scenes — in any combination of DIM, CCT, HUE and SAT — and recall them with five 0-10V presets.

2 ELECTRICAL & MECHANICAL SPECIFICATIONS

2.2 Mechanical Specifications

Dimensions	Diameter:	1.97 inches (50 mm)
	Height:	0.67 inches (17 mm); CTM 119NR: 0.84 inches (21.44 mm)
Light Emitting Surface		9 mm, 12mm and 19 mm (nominal)
Weight		0.12 pounds (0.06kg)
Heat Sink Attachment		Front mount, M2.5 or 4-40 Screws
Max Case Temperature		≤90°C

CTM 119 (1250 lumens), CTM 112, CTM 109

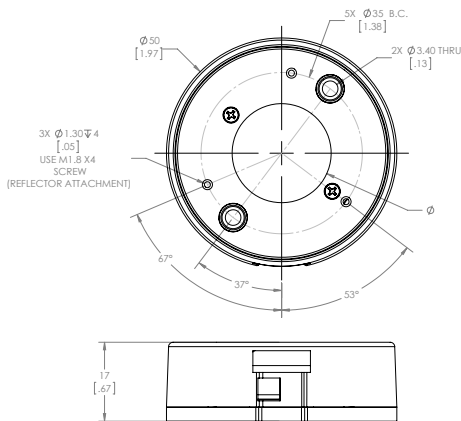

Model	LES Diameter
CTM 109	9.5 mm (0.37 inches)
CTM 112	12.75 mm (0.50 inches)
CTM 119	22 mm (0.87 inches)

CTM 119NR (1250 lumens) – Raised Face

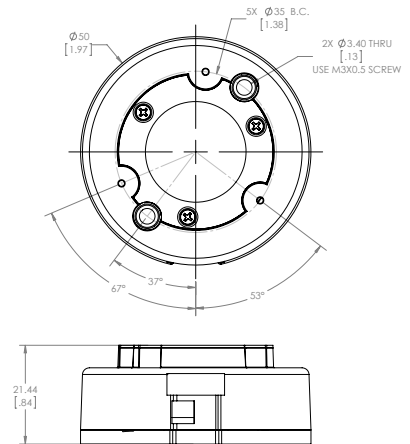

CTM 119 (2000 / 1500 lumens)

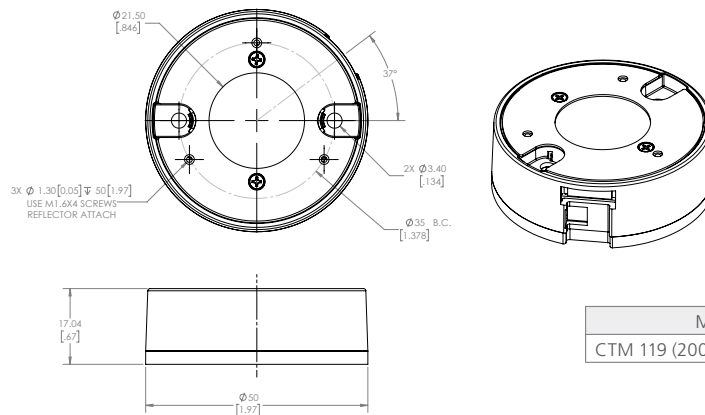

Model	LES Diameter
CTM 119 (2000 / 1500 lumens)	22 mm (0.87 inches)

3 POWER SUPPLY REQUIREMENTS

3.1 Electrical Specifications

Description and Nominal Power Input	CTM 109/112/119/119NR, 12W	CTM 109/112/119/119NR, 18W	CTM 109/112/119/119NR, 25W	CTM 119, 35W
Input Voltage	24V DC	24V DC	24V DC	24V DC
Nominal Current Input	12.5W: 0.52A	18W: 0.75A	25W: 1.04A	35W: 1.46A
Power Supply Classification	Class 2 (UP TO 100W)	Class 2 (UP TO 100W)	Class 2 (UP TO 100W)	Class 2 (UP TO 100W)

IMPORTANT

The Color Tuning Module has on-board drive electronics, including dimming. A dimming driver should NOT be used.

3.2 Recommended Power Supplies (Constant Voltage)

Manufacturer	Part Number	Rated Power	12W Module	18W Module	25W Module (1250 lumens)	25W Module (1500 lumens)	35W Module
Mean Well	APV-25-24	25W	✓	✓			
High Perfection Tech HK (MagTech)	LP1026-24	30W	✓	✓	✓		
Mean Well	APV-35-24	35W	✓	✓	✓		
Efore / Roal	Strato RSLP035-24	36W	✓	✓	✓		
ERP	VLM40W-24	40W	✓	✓	✓		
Inventronics	EUV-042S024PS	42W				✓	✓
ERP	VLM60W-24	60W				✓	✓
Mean Well	IRM-60-24ST	60W				✓	✓
Efore / Roal	Strato RSLP070-24	72W				✓	✓
Mean Well	APV-100-24 *	100W	✓	✓	✓		
Mean Well	HLG-120H-24A **	120W	✓	✓	✓		
Gre Alpha	XLD200-2-24V-FC	200W	✓	✓	✓	✓	

CAUTION:

- Using a constant current power supply will damage the module, and will void the Lumenetix warranty.
- Using a triac or dimming driver will damage the module, and will void the Lumenetix warranty.
- The power supply MUST be evaluated with the module(s) that it will be operated with.
- If a recommended power supply from the above list is not used, it will void the Lumenetix warranty.
- If unqualified power supplies are used in a fixture, it will void the Lumenetix warranty.
- It is the responsibility of the fixture manufacturer to ensure that the power supply performance does not change over time. The Lumenetix warranty is void if problems occur as a result of such changes.
- **DO NOT HOT PLUG THE LIGHT FIXTURES.**

*TESTED WITH A QUANTITY OF THREE 25W MODULES.

**U.L. CLASS 1 — NON-NORTH AMERICA ONLY.

NOTES:

- Recommendations are subject to change. Consult your Lumenetix representative for the most updated list.
- Please contact the power supply manufacturer to verify that the current version of the listed power supply still meets the latest Lumenetix testing approvals / qualifications.
- Power supply qualification process:: if a power supply that is not part of the above list is submitted for testing to Lumenetix (during the design-in phase), it will be qualified or disqualified within two weeks of submission.

4 HEAT SINKING RECOMMENDATIONS

The Color Tuning Module requires an external heat sink in order to ensure proper operating temperature of the LEDs. The CTM has a conductive aluminum case and an efficient thermal path to the LED array. These features promote efficient thermal management and allow for a simple heat sink design in most applications.

Examples of heat sinking methods are cast or extruded heat sinks. Both carbon and stainless steel are much less efficient at transferring heat than aluminum and therefore are not recommended as heat sink materials. The heat sink mounting surface should be flat and smooth. Metal-to-metal contact surfaces will result in best performance; anodized or unfinished mounting surfaces are recommended. Mounting the CTM on a painted aluminum surface will reduce the performance of the heat sink material.

In many fixtures, the air flow to the heat sinks is obstructed or the heat sink is in an enclosed container with no path to reject heat. The thermal design of the fixture must be optimized so that the maximum temperature is less than the $T_{c_{max}}$ (maximum case temperature) as indicated in the drawings in the following section. If the $T_{c_{max}}$ is exceeded in the application, the junction temperature of the LEDs will be higher than that required to meet the L70 life, and the Lumenix warranty will be void.

IMPORTANT: Most heat sinks are qualified in “free air” at an approximate ambient temperature of 25°C. If the CTM is installed in an insulated can fixture (IC Can), the module may exceed the recommended operating temperature. The heat sink must be evaluated and temperature tested in the fixture at applicable ambient temperatures for the desired application.

5 CASE TEMPERATURE MEASUREMENT POINTS

The thermal management characteristics of the heat sink used with the CTM1 should be validated by measuring its case temperature. This test should be done with the CTM1 installed in the fixture at ambient temperature and air flow conditions similar to the end-use installation.

The power draw of the CTM1 family varies by approximately one watt over the CCT range with peak power draw occurring at the CCT shown in the following table. The case temperature should be measured at the following CCT setting.

CCT Setting for Case Temperature (T_c) Measurement

CCT range	CCT Setting to Measure T _c
1650 – 8000K	3500K

The proper case temperature measurement location is on the narrow metal band, next to the power lead port; see figure below. The case temperature reading should be made after the unit has reached steady state, where the case temperature levels out. It is recommended to design the thermal management system for a case temperature of 90°C.

Maximum case temperature: 90°C

The Color Tuning Module has on-board thermal protection to reduce the current to the LEDs when the maximum case temperature is exceeded. This prevents unacceptably high LED junction temperatures by slightly dimming the module.

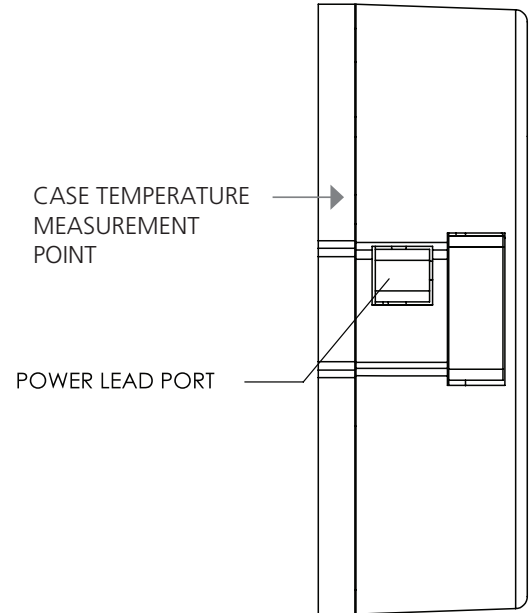
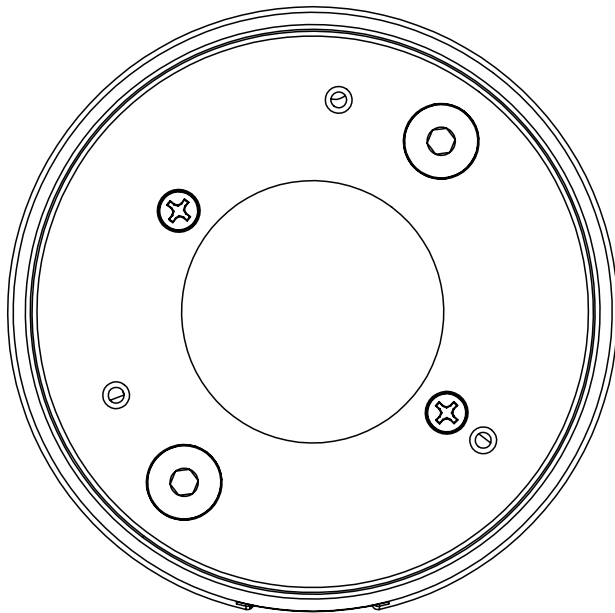

Case Temperature Measurement Point

6 SECONDARY OPTICS

6.1 Attaching Compatible CTM1 Reflectors

CTM 119 (2000 / 1500 lumens) accepts either twist-to-lock reflectors with the Xicato XSA-242 adapter ring, or reflectors for direct attachment to the module. CTM 109, CTM 112 and CTM 119 have provisions for TE Type-2 clip reflectors. CTM 119NR accepts twist-to-lock reflectors with an attachment collar. The fastener specifications are shown in the following table while mounting hole locations are shown in the figures below.

CTM1 Secondary Optics Fastener Specifications

CTM1 Reflector	Fastener specifications	Screw length	Notes
Twist Lock w/ XSA-242 Adapter Ring	M3-0.5 x 18	18 mm	Machine screws; attach to heat sink (not directly to module)
Direct Attachment	M1.6 x 4	4 mm	Thread forming; use flat head screws
TE Type 2 Clip	M3-0.5 x 25	25 mm	Machine screws; attach to heat sink (not directly to module)
Twist Lock w/ Collar (CTM 119NR)	2 - 28; M1.8 x 6	6 mm	Thread forming; use flat head screws

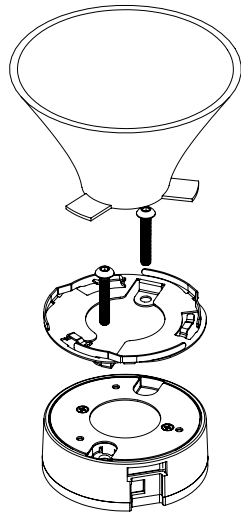

CTM 119 (2000 / 1500 lumens) Twist-Lock Style Reflectors with Xicato XSA-242 Adapter Ring

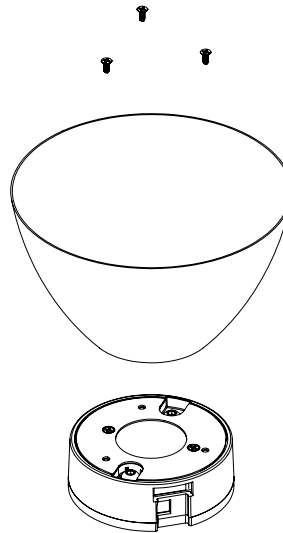

CTM 119 (2000 / 1500 lumens) Direct Attachment Reflectors

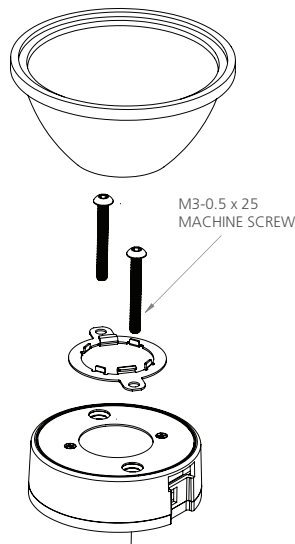

CTM 119 (1250 lumens) / CTM 112 / CTM 109 TE Type 2 Clip Reflectors (by Khatod)

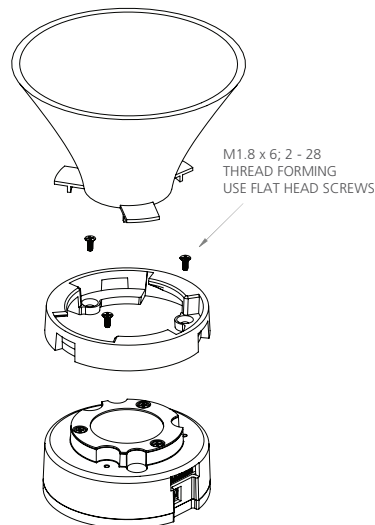

CTM 119NR (1250 lumens) Twist-Lock Style Reflectors with Attachment Collars

6 SECONDARY OPTICS

6.2 Compatible Reflectors for CTM 109 and CTM 112

Compatible Reflectors for CTM 109

Manufacturer	M. Part Number	beam angle (deg)	outer dim (mm)	height (mm)	optical finish	optical finish 2	attach method
Khatod EASY	KCLP 1858ME		72	52	honeycomb lens	none	Zhaga Screw 35mm
Khatod EASY	KCLP 1858WI		72	52	bug eye lens	none	Zhaga Screw 35mm
Khatod Lyra	PLJT 1521				diffuser ball white		TE Type II

Compatible Reflectors for CTM 112

Manufacturer	M. Part Number	beam angle (deg)	outer dim (mm)	height (mm)	optical finish	optical finish 2	attach method
Diffraction Optics	P13827	20	69	33	specular	superfacet, diamond	P13688, screw 35mm
Diffraction Optics	P13829	30	69	33	specular	superfacet, diamond	P13688, screw 35mm
Diffraction Optics	P13767	20	75	42.3	specular	superfacet, diamond	P13688, screw 35mm
Diffraction Optics	P13831	30	75	42.3	specular	superfacet, diamond	P13688, screw 35mm
Diffraction Optics	P13771	20	85	43.3	specular	superfacet, diamond	P13688, screw 35mm
Diffraction Optics	P13833	30	85	43.3	specular	superfacet, diamond	P13688, screw 35mm
Diffraction Optics	P13775	20	92	43.3	specular	superfacet, diamond	P13688, screw 35mm
Diffraction Optics	P13781	30	92	43.3	specular	superfacet, diamond	P13688, screw 35mm
Diffraction Optics	P13713	20	75	37	specular	faceted	P13688, screw 35mm
Diffraction Optics	P13715	35	75	37	specular	faceted	P13688, screw 35mm
JORDAN	11324 10 10101	25	111	66	specular	super facet	none
JORDAN	11324 00 10101	40	111	66	specular	super facet	none
JORDAN	11323 90 15101	40	75	42	specular	square sf	none
JORDAN	11415 60 10101	35	75	43	specular	fish scale sf	none
JORDAN	11415 40 10101	20	75	43	specular	fish scale sf	none
Khatod	KCLP 1682 ST (1429ST)	20	65	35	diffuse	none	TE Type II
Khatod	KCLP 1683 ST (1430ST)	24	65	35	diffuse	none	TE Type II
Khatod	KCLP 1685 ST (1432ST)	32	65	35	diffuse	none	TE Type II
Khatod	KCLP 1684 ST	28	65	35	diffuse	none	TE Type II
Khatod	KCLP 1687 ST	31	65	35	diffuse	none	TE Type II
Khatod	KCLP 1688 ST	38	65	35	diffuse	none	TE Type II
Khatod	KCLP 1689 ST	42	65	35	diffuse	none	TE Type II
Khatod	KCLP 1690 ST	50	65	35	diffuse	none	TE Type II
Khatod	KCLP 1691 ST	56	65	35	diffuse	none	TE Type II
Khatod EASY	KCLP 1858ME		72	52	honeycomb lens	none	Zhaga Screw 35mm
Khatod EASY	KCLP 1858WI		72	52	bugeye lens	none	Zhaga Screw 35mm
Khatod Lyra	PLJT 1521				diffuser ball white		TE Type II
Nata	3990-E	24	75	43	diffuse	super facet	none
Nata	3991-E	36	75	43	diffuse	super facet	none
Nata	3992-E	25	85	50.5	diffuse	super facet	none
Nata	3993-E	40	85	50.5	diffuse	super facet	none
Nata	4-1405E	16	98	66.4	specular	facets	none
Nata	4-1406E				diffuse	super facet	none
Nata	2-1535E		75	44	m-diffuse	super facet	none
Nata	4-1664E	24	111	65	m-diffuse	super facet	none / 3 tabs
Nata	4-1666E	38	111	65	diffuse	super facet	none / 3 tabs
Nata	4-1667E	45	111	61.3	m-diffuse	super facet	none
Nata	4-1820E	60	111	65	diffuse	super facet	none / 3 tabs
Widgerm	3205-BL	36	82	45	diffuse	faceted	none
Widgerm	1021-CZ, -LG	~43	50	24.5	satn	faceted	none
Widgerm	1128-CZ, -LG	~28	50	24.5	satn	none	none
Widgerm	2201-medium LES	10	72	43	diffuse	faceted	none
Widgerm	2202-medium LES	36	72	43	m-specular	faceted	none

NOTE: Reflectors have been recommended based on independent optical tests conducted by Lumenetix, and should be used as guidelines. Final reflector evaluation should be made by fixture manufacturers with all optics in place.

6 SECONDARY OPTICS

6.3 Compatible Reflectors for CTM 119 (1250 lumens)

Manufacturer	M. Part Number	beam angle (deg)	outer dim (mm)	height (mm)	optical finish	optical finish 2	attach method
JORDAN	11324 10 10101	25	111	66	specular	super facet	none
JORDAN	11324 00 10101	40	111	66	specular	super facet	none
Khatod EASY	KCLP 1858ME		72	52	honeycomb lens	none	Zhaga Screw 35mm
Khatod EASY	KCLP 1858WI		72	52	bugeye lens	none	Zhaga Screw 35mm
Khatod EASY	KCLP 1799 CR	asym			specular	none	Zhaga Screw 35mm
Khatod	KCLP 1682 CR (1429CR)	11	65	35	specular	none	TE Type II
Khatod	KCLP 1682 ST (1429ST)	20	65	35	diffuse	none	TE Type II
Khatod	KCLP 1683 ST (1430ST)	24	65	35	diffuse	none	TE Type II
Khatod	KCLP 1432 CR		65	35	specular	none	TE Type II
Khatod	KCLP 1685 ST (1432ST)	32	65	35	diffuse	none	TE Type II
Khatod	KCLP 1684 ST	28	65	35	diffuse	none	TE Type II
Khatod	KCLP 1687 CR	27	65	35	specular	none	TE Type II
Khatod	KCLP 1687 ST	31	65	35	diffuse	none	TE Type II
Khatod	KCLP 1688 CR	37	65	35	specular	none	TE Type II
Khatod	KCLP 1688 ST	38	65	35	diffuse	none	TE Type II
Khatod	KCLP 1689 ST	42	65	35	diffuse	none	TE Type II
Khatod	KCLP 1690 ST	50	65	35	diffuse	none	TE Type II
Khatod	KCLP 1691 ST	56	65	35	diffuse	none	TE Type II
Khatod	PLJT 1521				diffuser ball white		TE Type II
Nata	3990-E	24	75	43	diffuse	super facet	none
Nata	3991-E	36	75	43	diffuse	super facet	none
Nata	3992-E	25	85	50.5	diffuse	super facet	none
Nata	3993-E	40	85	50.5	diffuse	super facet	none
Nata	4-1149E2	39	111	65	m-diffuse	super facet	none
Nata	4-1150E5	39	111	65	m-diffuse	super facet	none
Nata	4-1405E	16	98	66.4	specular	facets	none
Nata	4-1406E				diffuse	super facet	none
Nata	2-1535E		75	44	m-diffuse	super facet	none
Nata	4-1536E	20	110	65.3	m-diffuse	super facet	none
Nata	4-1537E	30	110	62	diffuse	super facet	none
Nata	4-1664E	24	111	65	m-diffuse	super facet	none / 3 tabs
Nata	4-1666E	38	111	65	diffuse	super facet	none / 3 tabs
Nata	4-1667E	45	111	61.3	m-diffuse	super facet	none
Nata	4-1820E	60	111	65	diffuse	super facet	none / 3 tabs
Widegerm	3150-CZ	~14	82	45	m-specular	faceted	none
Widegerm	3158-CZ	15	91.5	47	diffuse	faceted	none
Widegerm	3163-CZ	22	91.5	47	m-specular	faceted	none
Widegerm	3205-BL	36	82	45	diffuse	faceted	none
Widegerm	2094-CZ	15	72	45	m-specular	faceted	none
Widegerm	2095-CZ	23	72	45.5	m-specular	faceted	none
Widegerm	2202-medium LES	36	72	43	m-specular	faceted	none

NOTE: Reflectors have been recommended based on independent optical tests conducted by Lumenetix, and should be used as guidelines. Final reflector evaluation should be made by fixture manufacturers with all optics in place.

6 SECONDARY OPTICS

6.4 Compatible Reflectors for CTM 119NR (1250 lumens)

Manufacturer	M. Part Number	beam angle (deg)	outer dim (mm)	height (mm)	optical finish	optical finish 2	attach method
Diffraction Optics	P7076 (xsa-17)						XSM T/L
Diffraction Optics	P6645						XSM T/L
Diffraction Optics	P6680						XSM T/L
Diffraction Optics	P7899 (xsa-22)	40	49.3	28.6	specular	faceted	XSM T/L
Diffraction Optics	P6764 (xsa-21)	60	50	29	specular	none	XSM T/L
JORDAN	11324 10 10101	25	111	66	specular	super facet	direct screws
JORDAN	11324 00 10101	40	111	66	specular	super facet	direct screws
Nata	3990-E	24	75	43	diffuse	super facet	none
Nata	3991-E	36	75	43	diffuse	super facet	none
Nata	3992-E	25	85	50.5	diffuse	super facet	none
Nata	3993-E	40	85	50.5	diffuse	super facet	none
Nata	4-1149E2	39	111	65	m-diffuse	super facet	none
Nata	4-1405E	16	98	66.4	specular	facets	none
Nata	4-1406E				diffuse	super facet	none
Nata	2-1535E		75	44	m-diffuse	super facet	none
Nata	4-1536E	20	110	65.3	m-diffuse	super facet	none
Nata	4-1537E	30	110	62	diffuse	super facet	none
Nata	4-1664E	24	111	65	m-diffuse	super facet	none / 3 tabs
Nata	4-1666E	38	111	65	diffuse	super facet	none / 3 tabs
Nata	4-1667E	45	111	61.3	m-diffuse	super facet	none
Nata	4-1820E	60	111	65	diffuse	super facet	none / 3 tabs
Widegerm	3159-CZ	34	91.5	47	m-specular	faceted	none
Widegerm	3205-BL	36	82	45	diffuse	faceted	none
Widegerm	2202-medium LES	36	72	43	m-specular	faceted	none

NOTE: Reflectors have been recommended based on independent optical tests conducted by Lumenetix, and should be used as guidelines. Final reflector evaluation should be made by fixture manufacturers with all optics in place.

6 SECONDARY OPTICS

6.5a Compatible Reflectors for CTM 119 (2000 / 1500 lumens) - Part-1

Manufacturer	M. Part Number	beam angle (deg)	outer dim (mm)	height (mm)	optical finish	optical finish 2	attach method
JORDAN	11324 10 10101	25	111	66	specular	super facet	none
JORDAN	11324 00 10101	40	111	66	specular	super facet	none
Khatod	KCLP 1682 ST (1429ST)	20	65	35	diffuse	none	XSA242 + KE1950W
khatod	KCLP 1683 CR (1430CR)	26	65	35	specular	none	XSA242 + KE1950W
khatod	KCLP 1683 ST (1430ST)	24	65	35	diffuse	none	XSA242 + KE1950W
khatod	KCLP 1685 ST (1432ST)	32	65	35	diffuse	none	XSA242 + KE1950W
khatod	KCLP 1688 CR	37	65	35	specular	none	XSA242 + KE1950W
khatod	KCLP 1688 ST	38	65	35	diffuse	none	XSA242 + KE1950W
khatod	KCLP 1689 ST	42	65	35	diffuse	none	XSA242 + KE1950W
khatod	KCLP 1690 ST	50	65	35	diffuse	none	XSA242 + KE1950W
khatod	KCLP 1691 ST	56	65	35	diffuse	none	XSA242 + KE1950W
khatod	PLJT 1866	n/a			diffuse ball		T/L XSM242
Nata	3990-E	24	75	43	diffuse	super facet	none
Nata	3991-E	36	75	43	diffuse	super facet	none
Nata	3992-E	25	85	50.5	diffuse	super facet	none
Nata	3993-E	40	85	50.5	diffuse	super facet	none
Nata	2-1050A	25	65	44	satın	none	XSA242
Nata	2-1131E	18	68	51	m-diffuse	facets	XSA242
Nata	2-1132E	30	68	51	m-diffuse	super facet	XSA242
Nata	2-1133E	45	68	51	m-diffuse	super facet, flare	XSA242
Nata	4-1149E2	39	111	65	m-diffuse	super facet	none
Nata	4-1150E5	39	111	65	m-diffuse	super facet	none
Nata	4-1405E	16	98	66.4	specular	facets	none
Nata	4-1406E				diffuse	super facet	none
Nata	2-1535E		75	44	m-diffuse	super facet	none
Nata	4-1536E	20	110	65.3	m-diffuse	super facet	none
Nata	4-1537E	30	110	62	diffuse	super facet	none
Nata	4-1664E	24	111	65	m-diffuse	super facet	none / 3 tabs
Nata	4-1666E	38	111	65	diffuse	super facet	none / 3 tabs
Nata	4-1667E	45	111	61.3	m-diffuse	super facet	none
Nata	4-1820E	60	111	65	diffuse	super facet	none / 3 tabs
Nata	3-1903M	40	79	51	m-diffuse	super facet	XSA242
Nata	4-1983E	24	110	65	specular	super facet	XSA242
Nata	2834A	43	70	43.5	satın	none	XSA242
Nata	4-1966E	7	111	65	m-diffuse	super facet	XSA242

NOTE: Reflectors have been recommended based on independent optical tests conducted by Lumenetix, and should be used as guidelines. Final reflector evaluation should be made by fixture manufacturers with all optics in place.

6 SECONDARY OPTICS

6.5b Compatible Reflectors for CTM 119 (2000 / 1500 lumens) - Part-2

Manufacturer	M. Part Number	beam angle (deg)	outer dim (mm)	height (mm)	optical finish	optical finish 2	attach method
Widgerm	1009T-XC	38	49	30.5	specular	faceted	XSA242 T/L
Widgerm	208x-XM		71.5	54	satın	lightfaceted	XSA242 T/L
Widgerm	2087-XM	19	71.5	54	m-specular	faceted	XSA242 T/L
Widgerm	2096T-XM	50	72	45.5	satın	lightfaceted	XSA242 T/L
Widgerm	2202T-XM	35	72	44	m-diffuse	faceted	XSA242 T/L
Widgerm	3204T-XM	27	82	46	m-diffuse	faceted	XSA242 T/L
Widgerm	3205T-XM	36	82	46	specular	faceted	XSA242 T/L
Widgerm	3207T-XC	-	82	46	satın	none	XSA242 T/L
Widgerm	4219T-XM	20	111	36	diffuse	faceted	XSA242 T/L
Widgerm	4220T-XM	37	111	36	m-specular	faceted	XSA242 T/L
Widgerm	4221T-XM	47	111	36	m-specular	faceted	XSA242 T/L
Widgerm	4201T-XC	15	111	69	diffuse	faceted	XSA242 T/L
Widgerm	4301T-XM	36	111	69	m-diffuse	faceted	XSA242 T/L
Widgerm	4401T-XM	43	111	69	m-diffuse	faceted	XSA242 T/L
Widgerm	3158-CZ	15	91.5	47	diffuse	faceted	none
Widgerm	3159-CZ	34	91.5	47	m-specular	faceted	none
Widgerm	3163-CZ	22	91.5	47	m-specular	faceted	none
Widgerm	3205-BL	36	82	45	diffuse	faceted	none
Widgerm	2094-CZ	15	72	45	m-specular	faceted	none
Widgerm	2095-CZ	23	72	45.5	m-specular	faceted	none
Widgerm	2202-medium LES	36	72	43	m-specular	faceted	none

NOTE: Reflectors have been recommended based on independent optical tests conducted by Lumenetix, and should be used as guidelines. Final reflector evaluation should be made by fixture manufacturers with all optics in place.

7 POWER / CONTROL CABLE ASSEMBLIES

7.1 Power Cable Assembly

Provides power to each module.
Lumenetix part #: 28.002.001.01

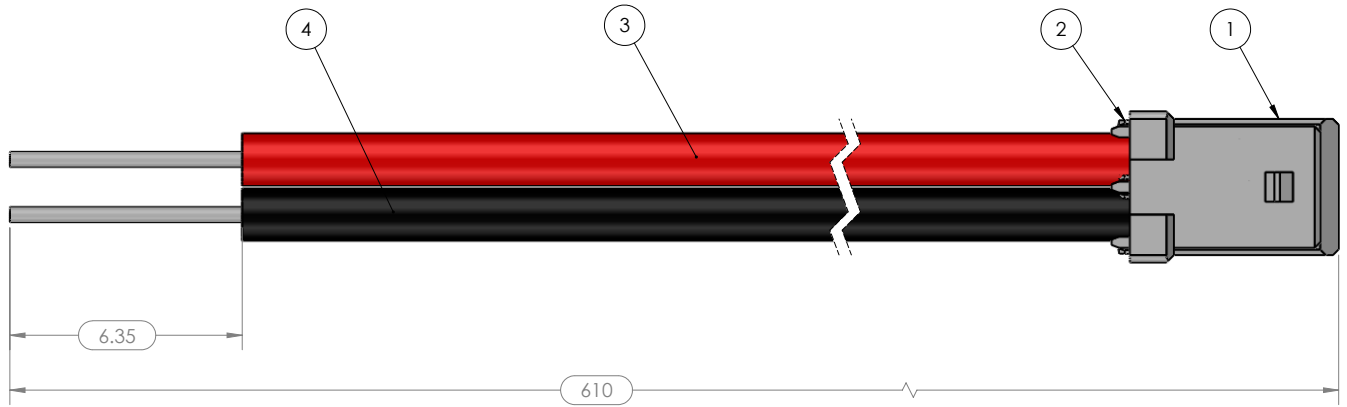

Note: All dimensions are in millimeters.

ITEM NO.	PART NUMBER	DESCRIPTION	QTY.
1	874390200	MOLEX CONNECTOR	1
2	874210000	CRIMP	2
3	A2015R-100-ND	24 AWG WIRE, RED	1
4	A2015B-100-ND	24 AWG WIRE, BLACK	1

7.1.2 Pin Allocation Chart for Power Cable Assembly

Pin #	Lead Color	Input
Pin 1	Red	Power 24V DC
Pin 2	Black	Power Common

7 POWER / CONTROL CABLE ASSEMBLIES

7.2 Control Cable Assembly (7-Wire)

Provides 0-10V and Lutron EcoSystem (with the Digital Control Adapter) control, and RS-485 signals to each module.
Lumenetix part #: 28.002.002.01

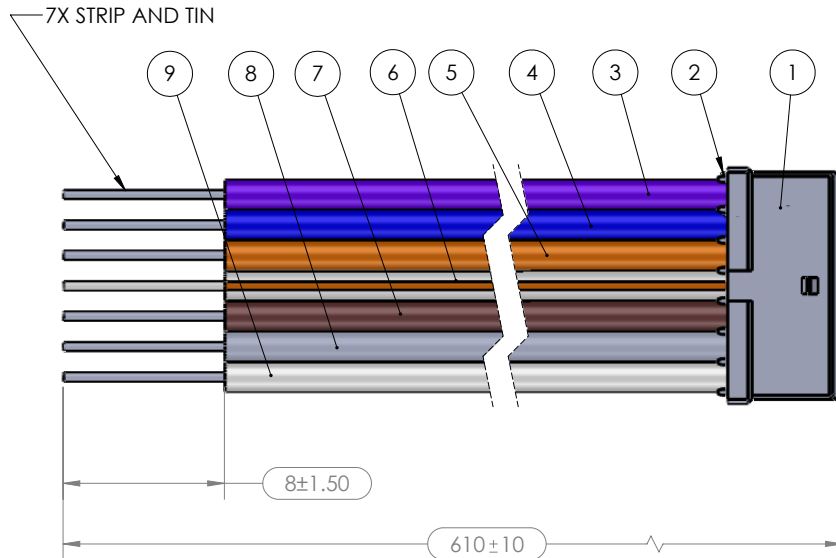

ITEM NO.	PART NUMBER	DESCRIPTION	QTY.
1	874390700	MOLEX CONNECTOR	1
2	874210000	CRIMP	7
3	VIOLET WIRE 24AWG	HOOK-UP WIRE STRANDED 7/32 24AWG VIOLET	1
4	BLUE WIRE 24AWG	HOOK-UP WIRE STRANDED 7/32 24AWG BLUE	1
5	ORANGE WIRE 24AWG	HOOK-UP WIRE STRANDED 7/32 24AWG ORANGE	1
6	WHITE WITH ORANGE STRIPE WIRE 24AWG	HOOK-UP WIRE STRANDED 7/32 24AWG WHITE WITH ORANGE STRIPE	1
7	BROWN WIRE 24AWG	HOOK-UP WIRE STRANDED 7/32 24AWG BROWN	1
8	GREY WIRE 24AWG	HOOK-UP WIRE STRANDED 7/32 24AWG GREY	1
9	WHITE WIRE 24AWG	HOOK-UP WIRE STRANDED 7/32 24AWG WHITE	1

7.2.2 Pin Allocation Chart for Control Cable Assembly

Pin #	Lead Color	Input
Pin 1	Violet	0-10V Dimming (+)
Pin 2	Blue	0-10V Color (+)
Pin 3	Orange	Data (-)
Pin 4	White with Orange Stripe	Data (+)
Pin 5	Brown	Digital Common
Pin 6	Gray	Signal Common for 0-10V Dimming (-)
Pin 7	White	Signal Common for 0-10V Color (-)

7 POWER / CONTROL CABLE ASSEMBLIES

7.3 Control Cable Assembly (7+3 Wire)

Provides dual-DMX control and RS-485 signals to each module.
Lumenetix part #: 28.002.002.05

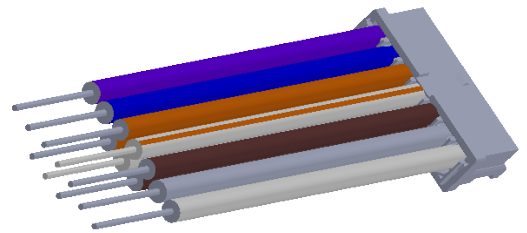
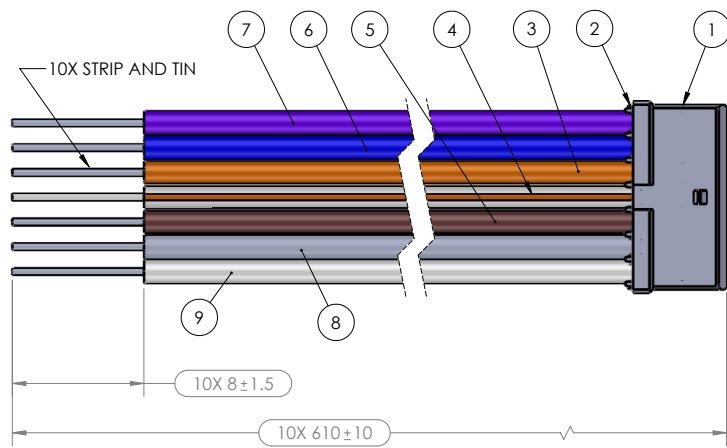

Note: All dimensions are in millimeters.

ITEM NO.	PART NUMBER	QTY.
1	CONNECTOR MOLEX 874390700	1
2	CRIMP MOLEX 874210000	7
3	HOOK-UP WIRE STRANDED 7-34 26 AWG ORANGE	2
4	HOOK-UP WIRE STRANDED 7-34 26 AWG WHITE WITH ORANGE STRIPE	2
5	HOOK-UP WIRE STRANDED 7-34 26 AWG BROWN	2
6	HOOK-UP WIRE STRANDED 7-32 24AWG BLUE	1
7	HOOK-UP WIRE STRANDED 7-32 24AWG VIOLET	1
8	HOOK-UP WIRE STRANDED 7-32 24 AWG GREY	1
9	HOOK-UP WIRE STRANDED 7-32 24AWG WHITE	1

7.3.2 Pin Allocation Chart for Control Cable Assembly

Pin #	Lead Color	Input
Pin 1	Violet	0-10V Dimming (+)
Pin 2	Blue	0-10V Color (+)
Pins 3a / 3b (TOP / BOTTOM)	Orange	Data (-) IN / OUT
Pins 4a / 4b (TOP / BOTTOM)	White with Orange Stripe	Data (+) IN / OUT
Pin 5a / 5b (TOP / BOTTOM)	Brown	Digital Common IN / OUT
Pin 6	Gray	Signal Common for 0-10V Dimming (-)
Pin 7	White	Signal Common for 0-10V Color (-)

8 WIRING DIAGRAMS

8.1 0-10V Best Wiring Practice

Any manufacturer that makes a dimmer that sinks will work with Lumenetix modules since we source the voltage.

0-10V is a topology defined by the International Electrotechnical Commission (IEC) 60929 Annex E standard and uses a varying DC voltage between 1 and 10V to determine the lighting level. The fixture outputs a minimum light level below 1V which is defined as low-end. Between 1 and 10V, the signal corresponds to levels between the minimum and maximum output level. A signal above 10V corresponds to the maximum light level. Sometimes it is referred to as 1-10V, as that is the actual range in which the light levels will vary. Each dimmer will have their own distinct dimming profile.

Best practice is to limit the distance run for the analog control wiring from the controller to the last driver to 300', as a common 0-10V DC wiring type is stranded-copper twisted-pair 18AWG wiring. The wiring is stranded copper because it provides a more stable current path (as DC signals tend to be transferred by the outer edges of the conductor) while being relatively easy to work with; solid wire is usually acceptable in low-voltage systems that use AC control power.

Whenever any part of the control circuit (the driver, dimer, or wire used) is designed for use in a Class 2 installation, it is critical that the entire control circuit be kept separate from Class 1 line voltage wiring per the requirement of National Electric Code, section 725.136. The electrical drawings must be very clear that class 1 and class 2 wiring cannot be combined. There must be separation because: a) it is possible for higher voltage wiring to induce an AC voltage in to the low voltage signal wiring; and, b) undesirable visual artifacts in the dimmed lighting can be caused when the line and low voltage wiring is run together (especially for long distances). We do not recommend installing the low voltage signal wiring in the same conduit or raceway as line voltage wiring even when all elements of the control circuit are listed for Class 1 wiring methods.

NOTE: Lumenetix modules operate between 1-10V. All dimmers that have minimum and maximum trim pots should be set at a minimum of 1 volt and a maximum of 10 volts, measuring the voltage at the end of the line.

0-10V Dimmers (recommended list)*

Crestron

ETC

Fresco

Legrand

Leviton

Lutron

Nexlight

N-Light

Pass & Seymour

Vantage

Wattstopper

*Recommendations are subject to change. Consult your Lumenetix representative for the most updated list.

8 WIRING DIAGRAMS

8.1.1 0-10V Analog Control of CCT and Dimming

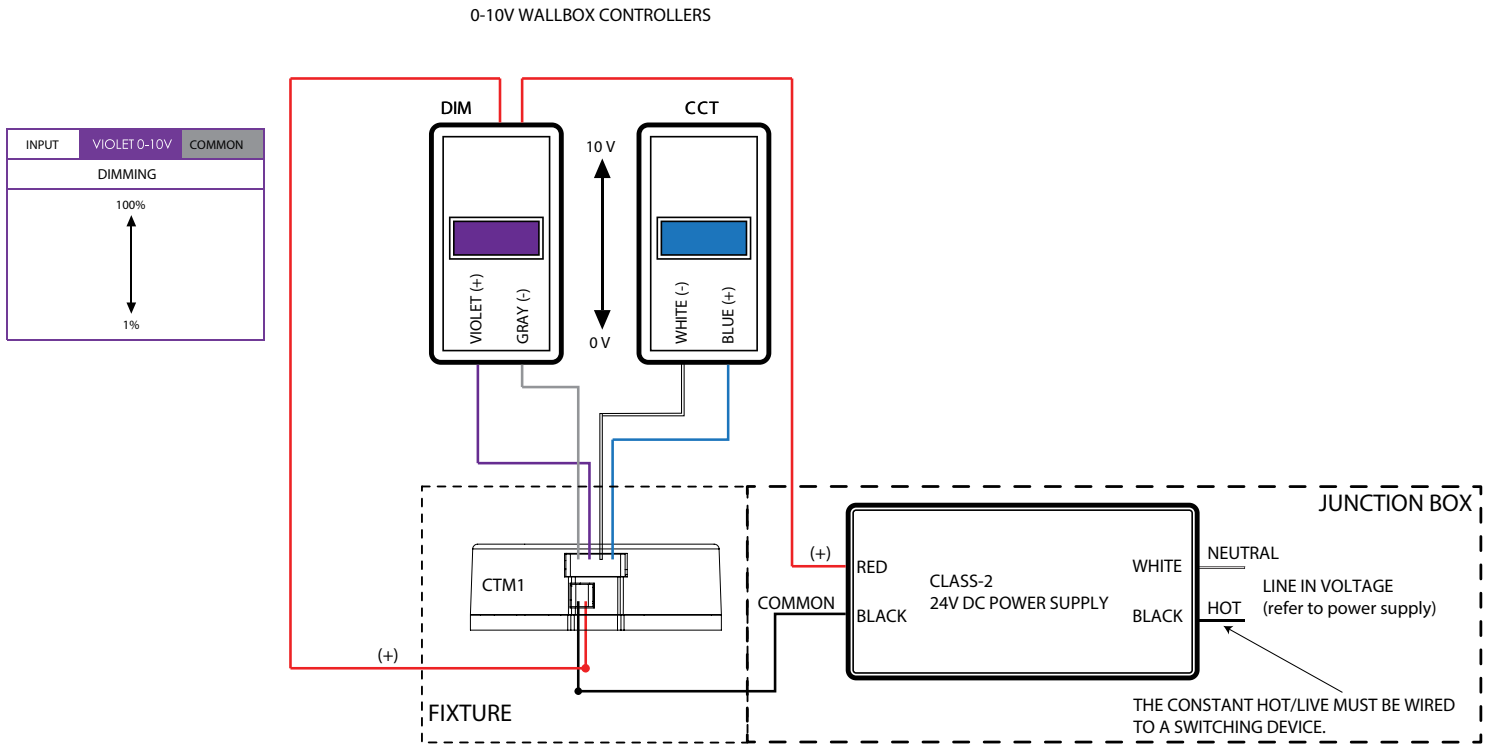

Lead Color and Input

Lead Color	Input
Red	Power 24V DC (+)
Black	Power Common (-)
Violet	0-10V Dimming (+)
Gray	Signal Common for 0-10V Dimming (-)
White	Signal Common for 0-10V Color (-)
Blue	0-10V Color (+)

Notes:

1. If 0-10V control is not being used for dimming, the violet control lead must be grounded to gray common lead.
2. CTM sources current to 0-10V control at 0.2mA nominal capacity.
3. *If using a wall box dimmer, power only the DIM unit. The CCT unit does not get line-in voltage.

Lumenetix part #s:
28.002.001.01 (power cable assembly)
28.002.002.01 (control cable assembly)

8 WIRING DIAGRAMS

8.1.2 0-10V Analog Control of Scenes / araya⁵ Tunable Color iOS App to Set or Amend Scenes

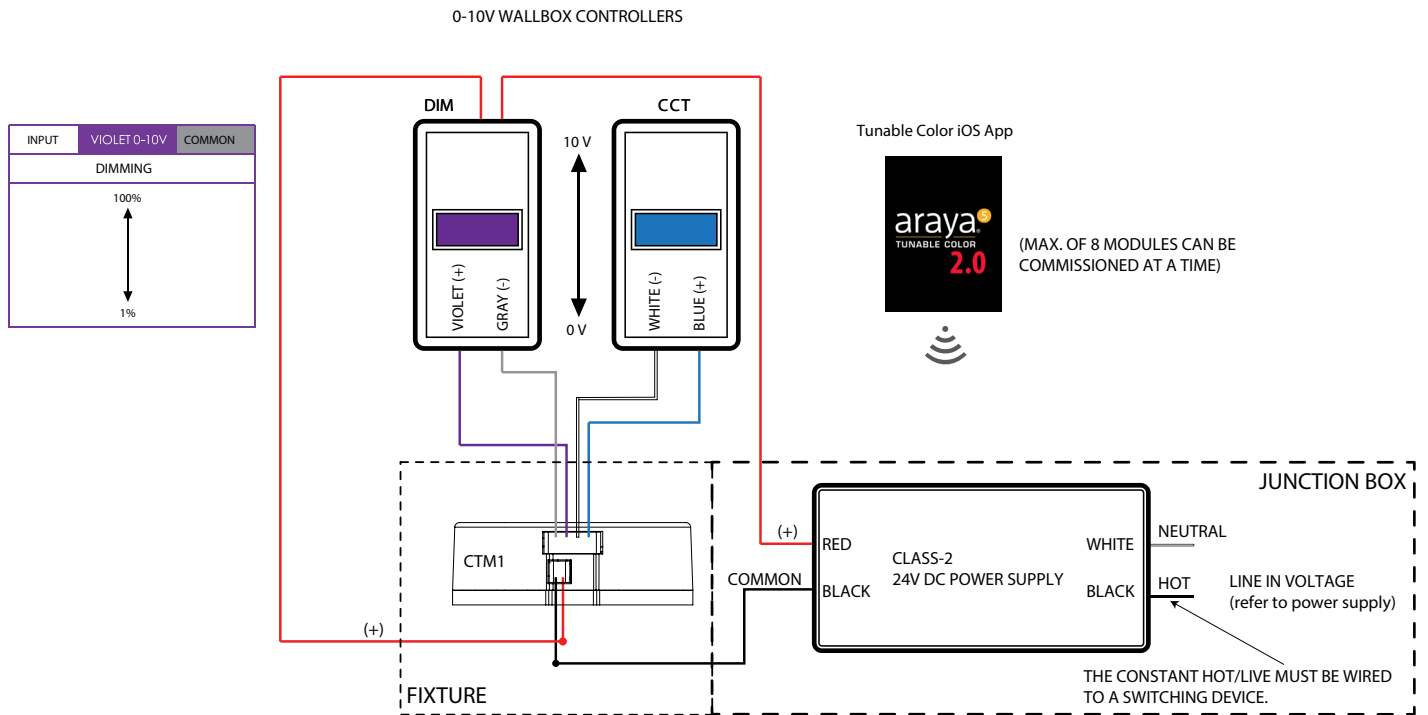

Lead Color and Input

Lead Color	Input
Red	Power 24V DC (+)
Black	Power Common (-)
Violet	0-10V Dimming (+)
Gray	Signal Common for 0-10V Dimming (-)
White	Signal Common for 0-10V Color (-)
Blue	0-10V Color (+)

Lumenix part #s:
28.002.001.01 (power cable assembly)
28.002.002.01 (control cable assembly)

Notes:

1. When the lamp is connected to a 0-10V line, the default is control of the continuous CCT range. The 0-10V line can instead be set to control scene set by sliding the Stored Scenes button to the "on" position in the araya⁵ Tunable Color iOS App. In this mode, the 0-10V control will toggle the light between up to 5 preset scenes. A scene is comprised of a CCT, Dim, Saturation & Hue level. Individual preset scenes can also be modified and activated with the iOS app. See araya⁵ Tunable Color Instruction Manual for more instructions.
2. If 0-10V control is not being used for dimming, the violet control lead must be grounded to gray common lead.
3. CTM sources current to 0-10V control at 0.2mA nominal capacity.
4. *If using a wall box dimmer, power only the DIM unit. The CCT unit does not get line-in voltage.

8 WIRING DIAGRAMS

8.2 Bluetooth Operation using the araya⁵ Tunable Color iOS App

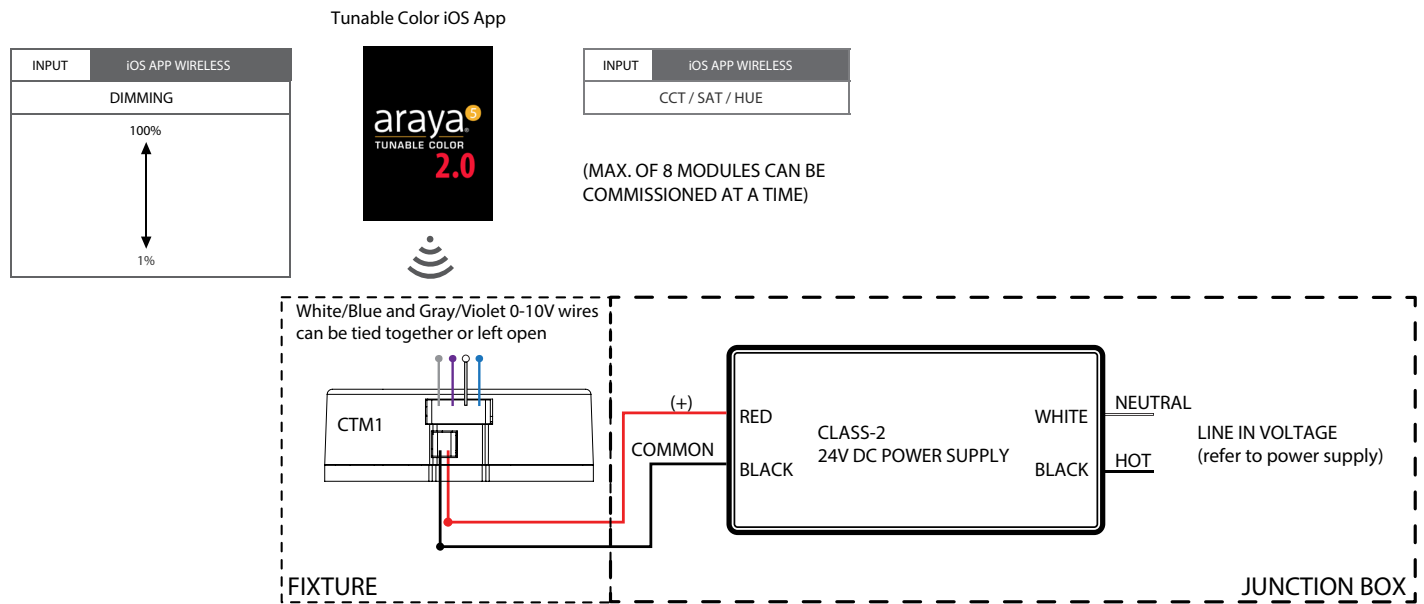

Lead Color and Input

Lead Color	Input
Red	Power 24V DC (+)
Black	Power Common (-)
Violet	0-10V Dimming + (left open)
Gray	Signal Common for 0-10V Dimming (-)
Blue	0-10V Color + (left open)
White	Signal Common for 0-10V Color (-)

Notes:

1. Maximum of 8 modules can be commissioned at a time.
2. Bluetooth operation should be used only for commissioning modules, NOT controlling them.
3. See araya⁵ Tunable Color Instruction Manual for more details.

Lumenetix part #s:
28.002.001.01 (power cable assembly)
28.002.002.01 (control cable assembly)

8 WIRING DIAGRAMS

8.3 DMX512-A Protocol

DMX512-A is an acronym for Digital Multiplex, a communication protocol used to remotely control lighting dimmers and intelligent fixtures. It is designed to provide a common communications standard between these lighting devices regardless of the manufacturer. The 512-A after the DMX refers to the number of control channels used on one network segment (often called a 'universe') of devices. In a simple dimming system, one channel controls the intensity of the fixture. A single intelligent fixture such as the araya⁵ requires several channels to control its various parameters (one channel each for DIM, CCT, SAT, HUE).

DMX512A Specifications:

- DMX 512-A (Controller).
- A universe is 512 Channels.
- DMX value is between 0 and 255, where 0 is off and 255 is full on.
- The maximum number of devices in a daisy-chain wire run is 32, which include the controller and opto-splitter.
- The maximum network wire run is a distance of up to 1600 feet for non-RDM systems and up to 1000 feet for RDM systems.
- One device functions as the master (DMX controller) on a network, while the rest function as slaves (mergers, splitters, intelligent fixtures, etc.).
- Only the controller (master) transmits over the network, and all fixtures receive the same data.
- The final device in the daisy-chain must be terminated with a 120 ohm resistor between DMX+ and DMX- pins.
- It is recommended that the terminator for the final device be located in the control panel, if it falls within the recommended wiring distance.
- All wiring must be in a continuous run and daisy-chained.
- Star wiring is only allowed in conjunction with an opto-splitter.
- Do not run DMX control cable in close proximity to AC power lines. EM spikes from switching of high-current devices such as HVAC equipment or generators will induce noise into the DMX cable.
- The shield must be carried through between modules and properly grounded at one point only.
- Connections to DMX512-A-RDM accessory board: wire size to be 24AWG, and solid or stranded cables may be used. Stranded wire used must be tinned or installed with ferule connector.

RDM

DMX512-A control protocol that enables Remote Device Management for two-way communications for configuration, monitoring and system setup. Allows two way communication between lighting controller and the fixtures. Allows for remote setting of DMX start addressing. RDM signals are sent back the other way, but not constantly. Controller can ask one or more devices for query feedback. RDM packets are inserted in-between the existing DMX data packets being used to control the lighting. The DMX Control Console will broadcast up to 512 channels over one DMX cable (max. run of 1000 feet for RDM). Some of these channels may not be used, but will still be transmitted, as required by the protocol. It must be set to a desired channel (001, 002, 003, 004, etc.) to control the connected light fixture. This is usually accomplished using RDM. This desired 'channel' is commonly known as the DMX address. When addressing fixtures, it is not recommended to skip addresses.

When RDM is not available with the control system, it is permissible to use the Lumenetix commissioning tool (the araya⁵ Tunable Color 2.0 iOS App) to set the address of the slots. The instructions to configure the DMX channels can be found in the separate araya⁵ Tunable Color Instruction Manual.

The DMX512-A interface follows the ANSI E1.11-2008 (R21013) standard. Four address slots are allocated to each interface board and control the Dim level, CCT, Saturation and Hue of the araya⁵ modules connected to the board.

Default DMX512-A Slot Allocation:

Slot	Function
1	Dim Level
2	CCT
3	Saturation Level
4	Hue

8 WIRING DIAGRAMS

8.3.1 DMX512-A Electrical Specifications

Parameter	Range	Remarks
ESD Protection	±15KV (air), ±8KV (conducted)	Per IEC 61000-4-2
Termination	Recommended	The DMX512 bus termination rules apply
Directionality	Receive only	
Frequency stability	±20ppm	
Load per port	1/256	1/8 of Nominal RS-485
Isolation	3KV _{rms}	

DMX512-A Control Systems (recommended list)

Choreo
Cognito
Crestron Greenlight System
Entec
ETC Mosaic
ETC Paradigm
Fresco
Interactive Technologies
Lutron HomeWorks QS
Lutron Quantum
Nicolaudie
Pathway Connectivity
Pharos
Traxon Ecue
Vantage Controls

*Recommendations are subject to change. Consult your Lumenetix representative for the most updated list.

DMX512-A Recommended Internal / Field Wiring

TMB Cable ProPlex DMX

PC224T: 2-pair DMX512 cable, overall foil and braid shielding with drain wire. UV and fungus resistant. Fully rated for installations, yet easy handling for light duty portable applications.

PC224TW: Same as above, with white jacket.

For use as DMX in/out under one jacket:

PC244T: Two individually shielded pairs and drain wires. UV resistant. Color coded foil shielding for easy reference.

8 WIRING DIAGRAMS

8.3.2 DMX512-A Recommended Field Wiring

Liberty 24-2P-485 (Non-Plenum), 24 AWG, 2 pair dual 120 ohm, 11.2 pf/ft low capacitance (Wago, XLR and PHX connectors)
 Liberty 24-2P-P485 (Plenum), 24 AWG, 2 pair dual 120 ohm, 11.2 pf/ft low capacitance (XLR and PHX connectors)
 Belden #9842 (Non-Plenum), 24 AWG, 2 pair dual shielded 120 ohm, 12.8 pf/ft low capacitance (XLR and PHX connectors)
 Belden #89842 (Plenum), 24 AWG, 2 pair dual shielded 120 ohm, 12.8 pf/ft low capacitance (XLR and PHX connectors)

Please refer to wire manufacturer’s lighting catalog for and/equals as required by code.

Category Wire or Equal

The Entertainment Services and Technology Association (ESTA) does not define a maximum run length for DMX over Cat5 since many factors will affect the maximum run length, such as number of devices, number of splices in the cable, the strength of the DMX transmitter(s), if Remote Device Management (RDM) is being used, and sources of interference. ESTA does state (again, in ANSI E1.21-2):

“A properly selected and installed DMX512 cable should provide acceptable signal strength for runs of 300m (1000ft). Please note that the technical requirements, such as run-length and topology for other networking technologies, such as Ethernet, should be considered if using the installed cable for another networking technology in the future is anticipated.”

Cat5 or equivalent is not preferred as a portable cable since it is not as rugged as other DMX cables. Male RJ45 connectors are especially prone to breakage over repeated re-connections.

LUMENETIX RECOMMENDATION:

CAT 5E -150 FEET

CRESTRON

DM-CBL-8G-NP

DM-CBL-8G-P

CAT 7- 330 FEET

CRESTRON

DM-CBL-ULTRA-NP

DM-CBL-ULTRA-P

DMX512-A Recommended Field Connectors (or Equal)

WAGO 221

PHOENIX CONTACT

XLR NEUTRIK

CRESTRON

RJ45 DM -8G-CONN

RJ45 IDC DM-CONN

DMX512-A Wiring Connections

Signal	Description	Pin Colors (4-Pair Cable)	Pin Colors (2-Pair Cable)	3-pin XLR connector	5-Pin XLR connector	5-Pin PHX connector
Signal Common		White/Brown and Brown	White/Blue and Blue	1	1	1
Data (-)	Primary Data Link	Orange	Orange	2	2	2
Data (+)	Primary Data Link	White/Orange	White/Orange	3	3	3
Data2 (-), or not used	Optional Secondary Data Link				4	4
Data2 (+), or not used	Optional Secondary Data Link				5	5

XLR Connectors (5-Pin)

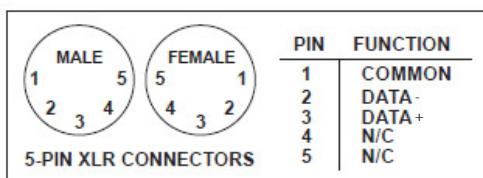

RJ-45 Connector Pin-Out (T568B)

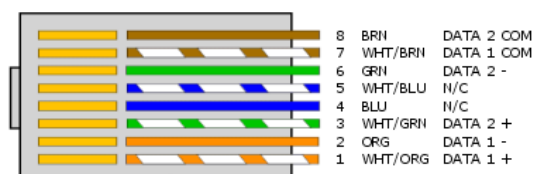

8 WIRING DIAGRAMS

8.3.3 DMX512-A Controller Example

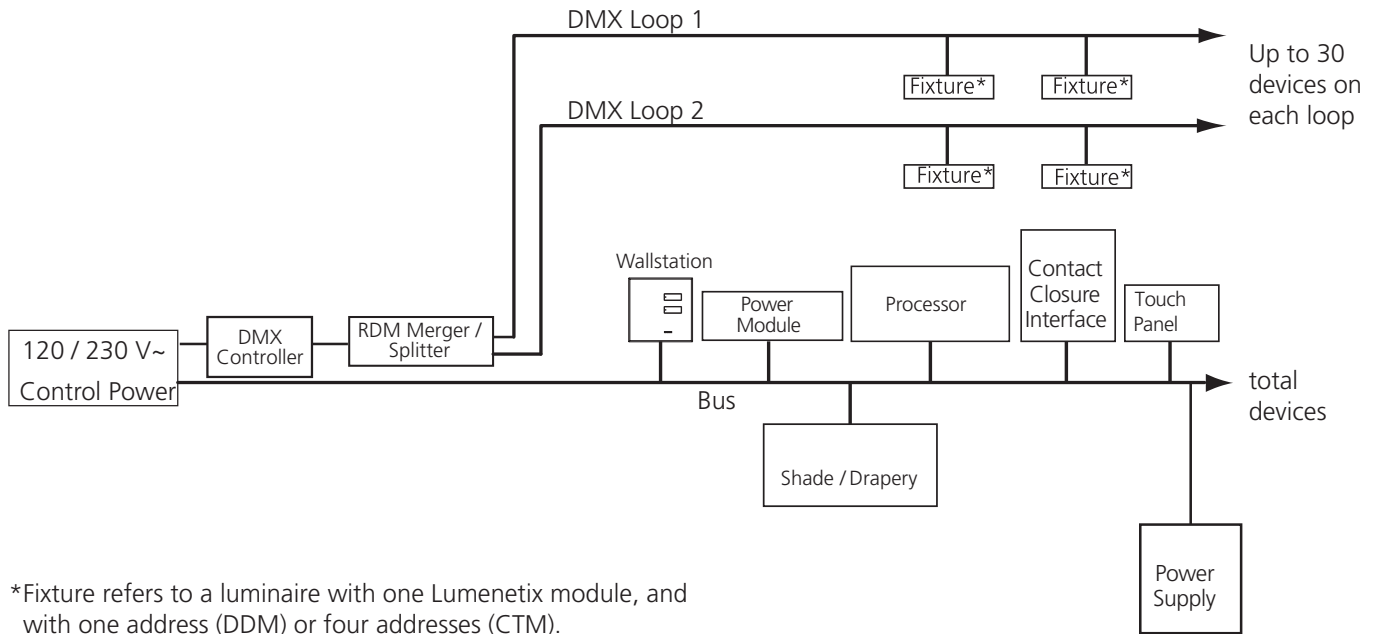

DMX512-A Drain Wire Connections

Drain wire connections are required as follows.

Shielding

To add another level of protection from electromagnetic noise, a grounded shield is added over the twisted pair wires. When this is enclosed in a protective jacket, to avoid ground loops and electromagnetic contamination of the ground system, all control ground wiring, including cable shields and drain wires, should be treated like sensitive current-carrying conductors. All control ground wires should be insulated (not bare) and the same wiring practices should be observed with ground wires as with other sensitive signals. Care must also be taken when designing control wiring to ensure that each shield is connected to only a single ground point. You should establish this point at a central location, like a control panel or cabinet, and avoid all connection to grounds in the field. A control ground is sometimes referred to as an isolated ground (an oxymoron) for this reason, but the term single-point ground is more accurate.

Method-1

A typical two-pair shielded cable can be prepared for termination to the terminals with the drain wire cut off. This is usually done at the field end of the cable where no shield grounding is desired. You will then use insulating tape or heat-shrink tubing to protect the cable from contamination and to prevent accidental grounding of the shield or drain wire. An accidental ground at this point would almost certainly create an undesirable ground loop.

Method-2

A typical two-pair shielded cable can be prepared for termination to the terminals with the drain wire cut off. The drain wire, which is an uninsulated conductor, is sleeved with a insulating tubing to prevent accidental grounding. The crimp-on lug is valuable in this instance to retain the tubing. Insulating tape or heat-shrink tubing is again used to protect the cable from contamination and to prevent accidental grounding, since any accidental connection between the drain wire and a chassis, frame, or enclosure would almost certainly create a ground loop.

8 WIRING DIAGRAMS

8.3.4 DMX512-A-RDM Control

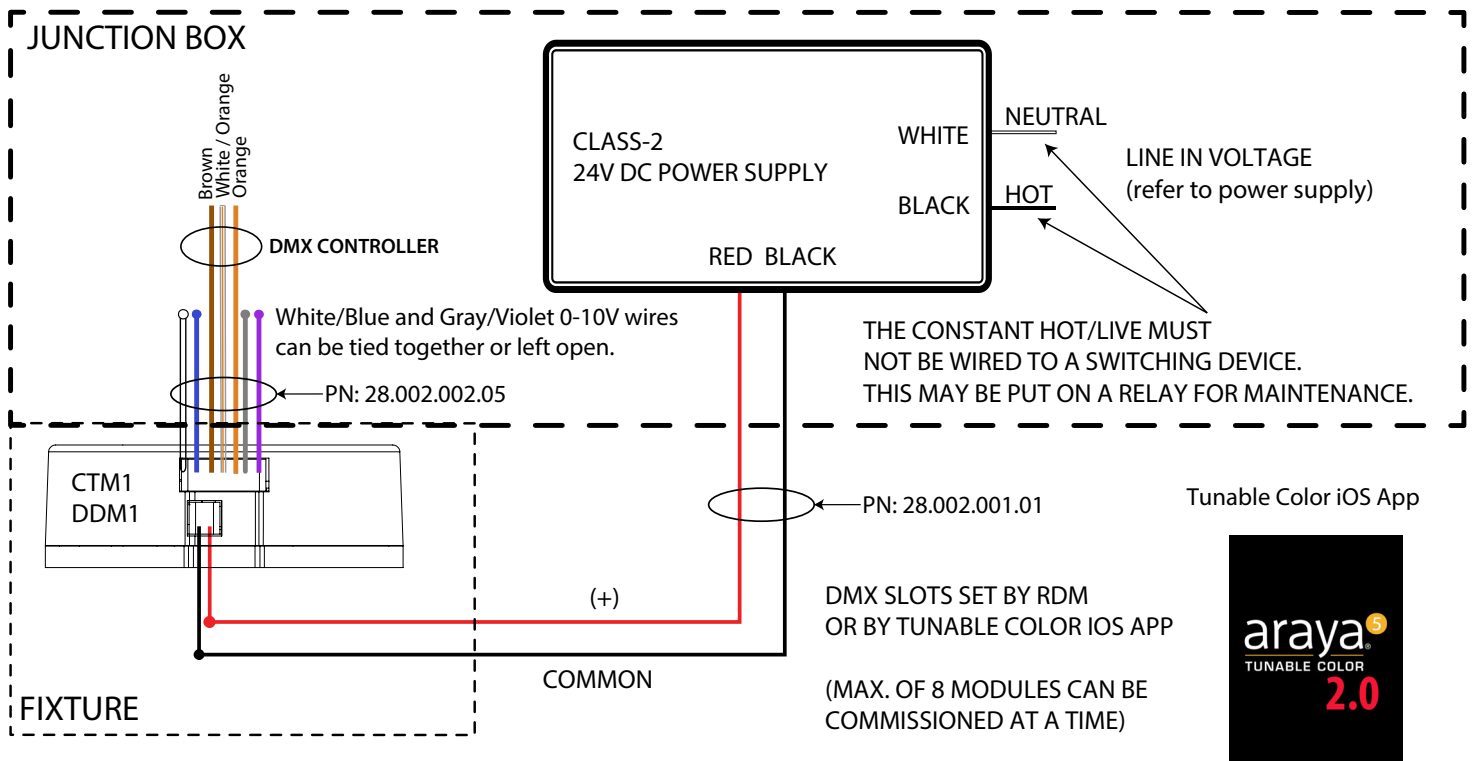

Lead Color and Input

Lead Color	Input
Red	Power 24V DC (+)
Black	Power Common (-)
Violet	0-10V Dimming (+); Left Open
Gray	Signal Common for 0-10V Dimming (-); Left Open
Blue	0-10V Color (+); Left Open
White	Signal Common for 0-10V Color (-); Left Open
Orange (TOP / BOTTOM)	Data (-) IN / OUT
White with Orange Stripe (TOP / BOTTOM)	Data (+) IN / OUT
Brown (TOP / BOTTOM)	Digital Common IN / OUT

Notes:

1. The DMX channels can be set by RDM or by using the araya⁵ Tunable Color iOS App.
2. Maximum of 8 modules can be commissioned at a time using the app.
3. Bluetooth operation should be used only for commissioning modules, NOT controlling them.
4. The DMX control system should first be powered OFF, and only modules that are connected to the DMX system should be powered on.
5. If more than one line of DMX is needed, then a DMX Splitter must be used to create multiple independent branches of a DMX signal and/or to extend the usable distance of each branch. Each of the splitter's 4, 6, 8, or 16 output ports generates an independently protected DMX signal.
6. See araya⁵ Tunable Color Instruction Manual for more details.

Lumenetix part #s:
28.002.001.01 (2-wire power cable assembly)
28.002.002.05 (7-wire control cable assembly)

8 WIRING DIAGRAMS

8.4 Lutron[®] EcoSystem Protocol

EcoSystem technology is a control method for LEDs that provides addressing of individual fixtures and status feedback. This makes it easy to digitally assign one or many fixtures without complicated wiring. This opens up an entire suite of energy-saving, system-monitoring and system-control schemes where the design, setup and rezoning are all done within software, making the electrical and control design simple.

The araya⁵ modules attached to different interface boards can be controlled independently or assigned to a single group by the EcoSystem controller.

The EcoSystem control is responsible for saving any configuration settings. Once an interface board is assigned a pair of addresses, assigned addresses are saved in NVRAM. During the EcoSystem discovery process, the user pairs the desired dimming control in the controller to the Dim channel address in the interface board. The same applies for the CCT channel.

- 1 pair 16AWG Eco Loop, 900 feet (**field wiring**).
- Maximum of 64 addresses on each loop.

EcoSystem Control Systems (recommended list)*

- Quantum System
- HomeWorks QS
- Grafik Eye QS Control Unit with EcoSystem
- EnergiSavr Node with EcoSystem
- Power Module with EcoSystem

*Recommendations are subject to change. Consult your Lumenetix representative for the most updated list.

Lutron EcoSystem Controller Example

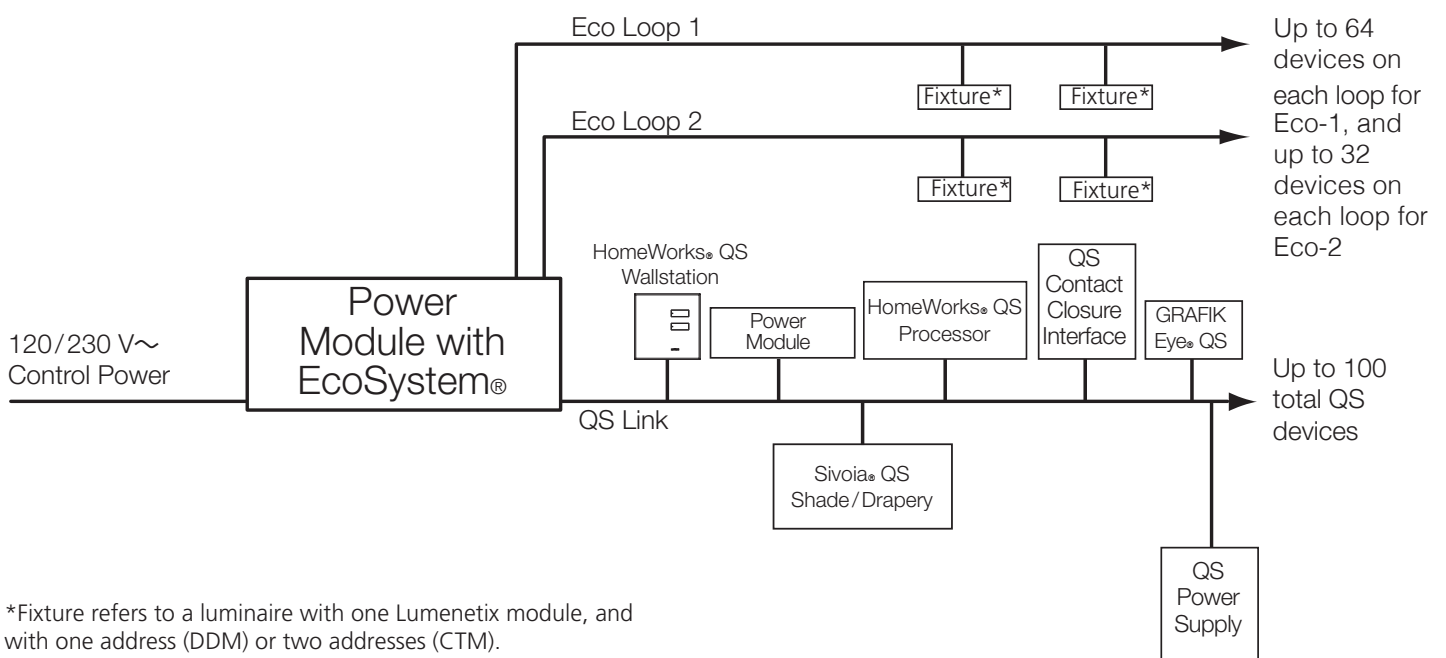

*Fixture refers to a luminaire with one Lumenetix module, and with one address (DDM) or two addresses (CTM).

8 WIRING DIAGRAMS

8.4.1 Lutron[®] EcoSystem Field Wiring

- EcoSystem Digital Loop can be wired as Mains voltage or IEC PELV/NECR Class 2 for maximum wiring flexibility..
- The Loop is polarity insensitive and can be wired in any topology..
- Consult all national and local electrical codes for separation requirements..

Wire Gauge	Maximum EcoSystem-Compliant Loop Wire Length
4.0 mm ² (12 AWG)	671 m (2200 ft)
2.5 mm ² (14 AWG)	427 m (1400 ft)
1.5 mm ² (16 AWG)	275 m (900 ft)
1.0 mm ² (18 AWG)	175 m (570 ft)

Drain Wire Connections

Drain wire connections are required as follows.

Shielding

To add another level of protection from electromagnetic noise, a grounded shield is added over the twisted pair wires. When this is enclosed in a protective jacket, to avoid ground loops and electromagnetic contamination of the ground system, all control ground wiring, including cable shields and drain wires, should be treated like sensitive current-carrying conductors. All control ground wires should be insulated (not bare) and the same wiring practices should be observed with ground wires as with other sensitive signals. Care must also be taken when designing control wiring to ensure that each shield is connected to only a single ground point. You should establish this point at a central location, like a control panel or cabinet, and avoid all connection to grounds in the field. A control ground is sometimes referred to as an isolated ground (an oxymoron) for this reason, but the term single-point ground is more accurate.

Method-1

A typical two-pair shielded cable can be prepared for termination to the terminals with the drain wire cut off. This is usually done at the field end of the cable where no shield grounding is desired. You will then use insulating tape or heat-shrink tubing to protect the cable from contamination and to prevent accidental grounding of the shield or drain wire. An accidental ground at this point would almost certainly create an undesirable ground loop.

Method-2

A typical two-pair shielded cable can be prepared for termination to the terminals with the drain wire cut off. The drain wire, which is an uninsulated conductor, is sleeved with a insulating tubing to prevent accidental grounding. The crimp-on lug is valuable in this instance to retain the tubing. Insulating tape or heat-shrink tubing is again used to protect the cable from contamination and to prevent accidental grounding, since any accidental connection between the drain wire and a chassis, frame, or enclosure would almost certainly create a ground loop.

8 WIRING DIAGRAMS

8.4.2 Lutron[®] EcoSystem Input; DCA-2 (24V DC) Digital Control Adapter

Notes:

1. 24V power (red/black) is Class-2 rated.
2. Module Data +/- (white with orange stripe/orange) to araya⁵ modules is Class-2 rated.
3. Adapter is configured at factory for EcoSystem inputs. The araya⁵ Tunable Color 2.0 iOS App should be turned on, and the DMX channels should be set to 2, 4, 6, 8.
4. DCA may be installed in the luminaire only.
5. One EcoSystem address (1 channel for warm-dim) per DDM module/DCA kit.
6. Two EcoSystem addresses (1 channel for CCT control and 1 channel for dimming control) per CTM module/DCA kit.
7. EcoSystem Channel 1 is always Intensity control. EcoSystem Channel 2 is always CCT control.
8. In the EcoSystem programming mode, EcoSystem Channel 1 controls the intensity from 100%-1%. EcoSystem Channel 2 controls the CCT range from 1650 - 8000K.
9. CAUTION: The power cable should ONLY be plugged into the 2-pin power receptacle provided. Insertion of the cable into any other slot will damage the Digital Control Adapter unit.
10. DMX Output used with this system.

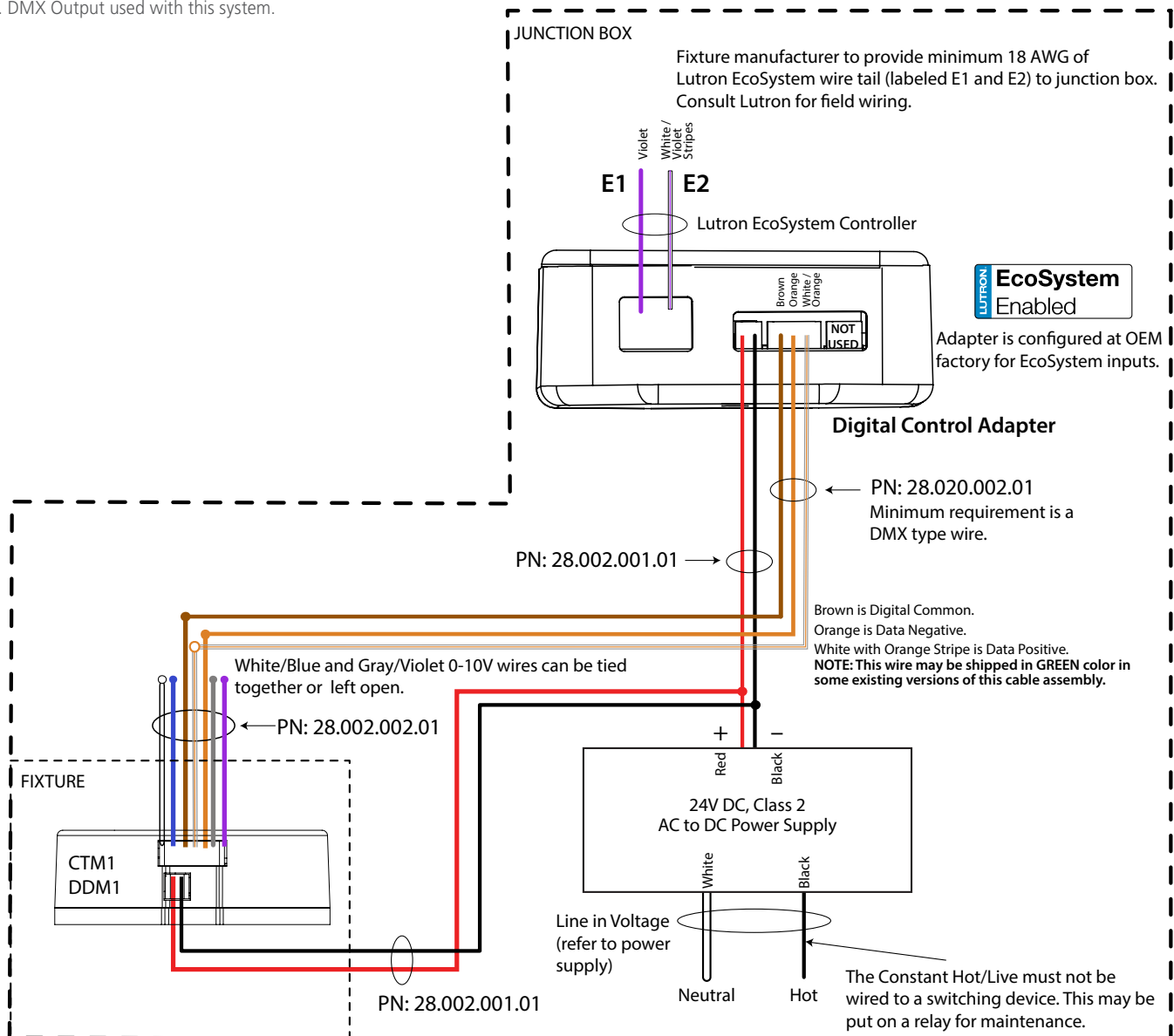

9 OPERATION GUIDE

The araya⁵ Color Tuning Modules CTM 109, CTM 112, CTM 119 and CTM 119NR utilize standard 0-10V building controls and/or a wireless araya⁵ Tunable Color iOS app for controlling on-Planckian correlated color temperatures (CCT), dimming values, off-Planckian color points (color tinting) using the Saturation & Hue feature, and commissioning and activating Scene presets. This document describes how to control the CTM utilizing 0-10V controls, the iOS Bluetooth app or a combination of the two.

araya⁵ Tunable Color iOS App. The araya⁵ Bluetooth app wirelessly controls the CTM. The app is primarily intended to commission the CTM after installation. A MAXIMUM OF 8 MODULES CAN BE CONTROLLED AT A TIME. Each CTM has a unique address and the operator uses the app to select the desired CTM, turn power on/off and then set CCT, Dim, Saturation & Hue, and set Scene Presets. Consult the araya⁵ Tunable Color instruction manual for detailed instructions.

0-10V Control of CCT. The CTM has 0-10V blue (+) and white (ground) control wire pairs to control CCT (instead of iOS app control of CCT).

0-10V Control of Stored Scenes. The iOS app can set up to 5 Scene Presets which are recalled using a wired 0-10V controller. A scene is comprised of a CCT, Dim, Saturation & Hue level. Individual preset scenes also can be modified and activated with the iOS app.

DMX Channel Configuration. The CTM1 modules are provided with on board DMX512-A-RDM, with DMX slots set by RDM or via wireless araya⁵ Tunable Color 2.0 iOS app.

On-Off Control. The CTM may be turned on/off by switching the input power from the 24V supply. To store the settings, the lamp needs to remain on for at least 45 seconds after the CTM is initially set using the iOS app. When Scene Presets are activated using the app, the settings are stored immediately and no wait time is needed. The lamp may also be turned on/off using the app without switching the power supply, but a power draw of about 1W will remain.

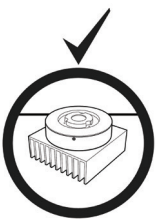

For long term reliable operation, proper heat sinking is critical.



The CTM diffuser is fragile. Avoid touching the diffuser during handling and assembly.



Do not rest or operate the CTM face down against a table or other solid surface.



lumenetix[®]
powered by ERP

Lumenetix Inc.
4742 Scotts Valley Drive
Scotts Valley, CA 95066
877.805.7284
www.erp-power.com